

RESPIRONICS®

# Millennium™ Oxygen Concentrators



Service & Technical Information



© 2007, Respironics, Inc. and affiliates. All rights reserved.



## LIMITED WARRANTY

Respironics, Inc. warrants that the system shall be free from defects of workmanship and materials and will perform in accordance with the product specifications for a period of three (3) years from the date of sale by Respironics, Inc. to the dealer. Respironics accessories are warranted to be free of defects in materials and workmanship for a period of 90 days from the time of purchase. If the product fails to perform in accordance with the product specifications, Respironics, Inc. will repair or replace – at its option – the defective material or part. Respironics, Inc. will pay customary freight charges from Respironics, Inc. to the dealer location only. This warranty does not cover damage caused by accident, misuse, abuse, alteration, and other defects not related to material or workmanship.

Respironics, Inc. disclaims all liability for economic loss, loss of profits, overhead, or consequential damages which may be claimed to arise from any sale or use of this product. Some states do not allow the exclusion or limitation of incidental or consequential damages, so the above limitation or exclusion may not apply to you.

This warranty is given in lieu of all other express or implied warranties, including the implied warranties of merchantability and fitness for a particular purpose. In addition, in no event shall Respironics be liable for lost profits, loss of good will, or incidental or consequential damages, even if Respironics has been advised of the possibility of the same. Some states or provinces do not allow the exclusion or limitation of implied warranties or the disclaimer of incidental and consequential damages. Accordingly, the laws of your state or province may give you additional protections.

To exercise your rights under this warranty, contact your local authorized Respironics, Inc. dealer or contact Respironics, Inc. at:



1001 Murry Ridge Lane  
Murrysville, PA 15668 USA

Visit Respironics Home Page on the World Wide Web at:

**[www.respironics.com](http://www.respironics.com)**

## REVISION HISTORY

SECTION NAME (No.)	REV. #	DATE	DESCRIPTION
<i>Copyright &amp; Warranty (1041826)</i>	00	5/5/2007	<i>Initial Revision</i>
<i>Revision History (1041845)</i>	01	5/5/2007	<i>Initial Revision</i>
<i>Table of Contents (1041909)</i>	00	5/5/2007	<i>Initial Revision</i>
<i>Introduction (1041846)</i>	00	5/5/2007	<i>Initial Revision</i>
<i>Warnings &amp; Cautions (1041847)</i>	00	5/5/2007	<i>Initial Revision</i>
<i>Specifications &amp; Features (1041848)</i>	00	5/5/2007	<i>Initial Revision</i>
<i>System Setup (1041812)</i>	00	5/5/2007	<i>Initial Revision</i>
<i>Theory of Operation (1041905)</i>	00	5/5/2007	<i>Initial Revision</i>
<i>Maintenance (1041813)</i>	00	5/5/2007	<i>Initial Revision</i>
<i>Troubleshooting (1041814)</i>	00	5/5/2007	<i>Initial Revision</i>
<i>H600/605 Repair &amp; Replacement (1041895)</i>	00	5/5/2007	<i>Initial Revision</i>
<i>M600/605 Repair &amp; Replacement (1041896)</i>	00	5/5/2007	<i>Initial Revision</i>
<i>M10600/M10605 Repair &amp; Replacement (1041898)</i>	01	5/5/2007	<i>Initial Revision</i>
<i>Enhanced M600/M605/M10600/M10605 Repair &amp; Replacement (1041897)</i>	00	5/5/2007	<i>Initial Revision</i>
<i>Repair Kits (1041901)</i>	00	5/5/2007	<i>Initial Revision</i>
<i>H600/605/M600/605/Enhanced M600/605 Testing (1041903)</i>	00	5/5/2007	<i>Initial Revision</i>
<i>M10600/M10605/Enhanced M10600/M10605 Testing (1041900)</i>	00	5/5/2007	<i>Initial Revision</i>
<i>Tools &amp; Equipment (1041902)</i>	00	5/5/2007	<i>Initial Revision</i>
<i>Schematics (1041904)</i>	00	5/5/2007	<i>Initial Revision</i>

*This page intentionally blank.*

**INTRODUCTION**

**MILLENNIUM OXYGEN CONCENTRATOR OVERVIEW.....1**  
**TYPES OF CONCENTRATORS .....1**  
**SERVICE NOTICE.....2**  
**SERVICE TRAINING.....2**  
**SERVICE/TECHNICAL SUPPORT STATEMENT.....2**

**WARNINGS & CAUTIONS**

**SECTION OVERVIEW.....1**  
**WARNINGS.....1**  
**CAUTIONS.....2**

**SPECIFICATIONS & FEATURES**

**SECTION OVERVIEW.....1**  
**H600/605, M600/605, & ENHANCED M600/605 SPECIFICATIONS .....2**  
**M10600/M10605 & ENHANCED M10600/M10605 SPECIFICATIONS .....4**  
**FRONT CABINET FEATURES.....6**  
**REAR AND SIDE CABINET FEATURES.....6**  
**CONTROL PANEL FEATURES .....7**

**SYSTEM SETUP**

**SECTION OVERVIEW.....1**  
**SYSTEM SETUP.....1**

**THEORY OF OPERATION**

**SECTION OVERVIEW.....1**  
**H600/605; M600/605; ENHANCED M600/605 CONCENTRATOR PNEUMATIC OPERATION .....1**  
**H600/605; M600/605; ENHANCED M600/605 CONCENTRATOR ELECTRICAL OPERATION .....2**  
**M10600/M10605; ENHANCED M10600/M10605 CONCENTRATOR PNEUMATIC OPERATION .....3**  
**M10600/M10605; ENHANCED M10600/M10605 ELECTRICAL OPERATION.....4**

**MAINTENANCE**

**MAINTENANCE INTERVALS.....1**

**TROUBLESHOOTING**

**SECTION OVERVIEW.....1**



**H600/605 CONCENTRATOR REPAIR & REPLACEMENT**

SECTION OVERVIEW..... 1  
OVERLAY REPLACEMENT ..... 2  
CASTER REPLACEMENT ..... 3  
BASE CABINET PAN REPLACEMENT ..... 4  
REAR CABINET REPLACEMENT..... 6  
FLOW METER REPLACEMENT ..... 8  
DISS OUTLET FITTING REPLACEMENT ..... 11  
POWER SWITCH REPLACEMENT ..... 13  
MAIN PCB FUSE REPLACEMENT ..... 15  
MAIN PCB REPLACEMENT ..... 16  
OPI WIRING HARNESS REPLACEMENT (MODEL H605 ONLY)..... 18  
OPI BOARD REPLACEMENT (MODEL H605 ONLY)..... 19  
POWER SWITCH WIRING HARNESS REPLACEMENT ..... 21  
O2/SOLENOID/BATTERY WIRING HARNESS..... 24  
FRONT CABINET REPLACEMENT ..... 27  
COOLING FAN REPLACEMENT ..... 29  
PERFORATED CANOPY REPLACEMENT ..... 31  
COMPRESSOR COVER REPLACEMENT..... 32  
MAIN POWER WIRING HARNESS REPLACEMENT ..... 33  
MOTOR START/RUN CAPACITOR ..... 36  
PRESSURE RELIEF VALVE REPLACEMENT ..... 37  
COMPRESSOR ASSEMBLY REPLACEMENT..... 38  
IN-LINE MUFFLER REPLACEMENT ..... 41  
HOUR METER REPLACEMENT ..... 43  
VALVE/SOLENOID REPLACEMENT ..... 45  
PRESSURE REGULATOR REPLACEMENT..... 47  
SIEVE CANISTER ASSEMBLY REPLACEMENT ..... 48  
BLOW DOWN MUFFLER REPLACEMENT ..... 50  
POWER CORD REPLACEMENT ..... 52

**M600/M605 CONCENTRATOR REPAIR & REPLACEMENT**

SECTION OVERVIEW..... 1  
OVERLAY REPLACEMENT ..... 2  
CASTER REPLACEMENT ..... 3  
BASE CABINET PAN REPLACEMENT ..... 4  
REAR CABINET REPLACEMENT..... 5  
FLOW METER REPLACEMENT ..... 7  
DISS OUTLET FITTING REPLACEMENT ..... 8  
POWER SWITCH REPLACEMENT ..... 9  
MAIN PCB FUSE REPLACEMENT ..... 11  
MAIN PCB REPLACEMENT ..... 12  
OPI WIRING HARNESS REPLACEMENT (MODEL M605 ONLY) ..... 14  
OPI BOARD REPLACEMENT (MODEL M605 ONLY) ..... 15



POWER SWITCH WIRING HARNESS REPLACEMENT.....	17
O2/SOLENOID/BATTERY WIRING HARNESS.....	20
FRONT CABINET REPLACEMENT.....	23
COOLING FAN REPLACEMENT.....	25
PERFORATED CANOPY REPLACEMENT.....	27
COMPRESSOR COVER REPLACEMENT.....	28
MAIN POWER WIRING HARNESS REPLACEMENT.....	29
MOTOR START/RUN CAPACITOR.....	31
COMPRESSOR ASSEMBLY REPLACEMENT.....	32
IN-LINE MUFFLER REPLACEMENT.....	34
HOUR METER REPLACEMENT.....	36
VALVE/SOLENOID REPLACEMENT.....	37
PRESSURE REGULATOR REPLACEMENT.....	39
SIEVE CANISTER ASSEMBLY REPLACEMENT.....	40
BLOW DOWN MUFFLER REPLACEMENT.....	42
POWER CORD REPLACEMENT.....	44

### **M10600/M10605 CONCENTRATOR REPAIR & REPLACEMENT**

SECTION OVERVIEW.....	1
OVERLAY REPLACEMENT.....	2
CASTER REPLACEMENT.....	3
BASE CABINET PAN REPLACEMENT.....	4
REAR CABINET REPLACEMENT.....	5
FLOW METER REPLACEMENT.....	7
DISS OUTLET FITTING REPLACEMENT.....	9
POWER SWITCH REPLACEMENT.....	11
MAIN PCB FUSE REPLACEMENT.....	14
MAIN PCB REPLACEMENT.....	15
OPI WIRING HARNESS REPLACEMENT (MODEL M10605 ONLY).....	17
OPI BOARD REPLACEMENT (MODEL M10605 ONLY).....	18
POWER SWITCH WIRING HARNESS REPLACEMENT.....	20
O2/SOLENOID/BATTERY WIRING HARNESS.....	23
FRONT CABINET REPLACEMENT.....	25
COOLING FAN REPLACEMENT.....	26
PERFORATED CANOPY REPLACEMENT.....	27
COMPRESSOR COVER REPLACEMENT.....	28
MAIN POWER WIRING HARNESS REPLACEMENT.....	29
CAPACITOR REPLACEMENT.....	31
COMPRESSOR ASSEMBLY REPLACEMENT.....	32
IN-LINE MUFFLER REPLACEMENT.....	34
HOUR METER REPLACEMENT.....	36
VALVE/SOLENOID REPLACEMENT.....	38
PRESSURE REGULATOR REPLACEMENT.....	39
SIEVE CANISTER ASSEMBLY REPLACEMENT.....	40





---

BLOW DOWN MUFFLER REPLACEMENT .....	41
POWER CORD REPLACEMENT .....	42

**ENHANCED M600/M605; ENHANCED M10600/M10605 CONCENTRATOR REPAIR & REPLACEMENT**

SECTION OVERVIEW.....	1
OVERLAY REPLACEMENT .....	2
CASTER REPLACEMENT .....	3
BASE CABINET PAN REPLACEMENT .....	4
REAR CABINET REPLACEMENT.....	5
FLOW METER REPLACEMENT .....	7
DISS OUTLET FITTING REPLACEMENT .....	9
POWER SWITCH REPLACEMENT .....	10
MAIN PCB TO POWER SWITCH WIRING REPLACEMENT .....	11
MAIN PCB TO BATTERY WIRING REPLACEMENT.....	12
MAIN PCB FUSE REPLACEMENT .....	13
MAIN PCB REPLACEMENT .....	14
OPI PCB REPLACEMENT (MODEL 605 ONLY).....	17
OPI WIRING HARNESS REPLACEMENT (MODEL 605 ONLY) .....	19
FRONT CABINET REPLACEMENT .....	20
COOLING FAN REPLACEMENT .....	22
MAIN PCB TO COOLING FAN WIRING REPLACEMENT .....	23
PERFORATED CANOPY REPLACEMENT .....	24
COMPRESSOR COVER REPLACEMENT.....	25
MOTOR START/RUN CAPACITOR REPLACEMENT.....	27
COMPRESSOR ASSEMBLY REPLACEMENT.....	28
MAIN PCB TO COMPRESSOR WIRING REPLACEMENT .....	31
THERMAL PROTECTION SWITCH REPLACEMENT .....	33
IN-LINE MUFFLER REPLACEMENT .....	34
HOURLY METER REPLACEMENT .....	36
VALVE/SOLENOID REPLACEMENT .....	38
PRESSURE REGULATOR REPLACEMENT.....	41
SIEVE CANISTER ASSEMBLY REPLACEMENT .....	43
BLOW DOWN MUFFLER REPLACEMENT .....	45
POWER CORD REPLACEMENT .....	47
BASE CABINET REPLACEMENT.....	48

**REPAIR KITS**

SECTION OVERVIEW.....	1
QUICK REFERENCE TABLE.....	2

**H600/605; M600/605; ENHANCED M600/605 TESTING**

**SYSTEM VERIFICATION PROCEDURES .....1**  
**MILLENNIUM SYSTEM FINAL TEST.....6**  
**MODEL 605 TEST DATA SHEET .....8**  
**MODEL 600 TEST DATA SHEET .....9**

**M10600/M10605 & ENHANCED M10600/M10605 TESTING**

**SYSTEM VERIFICATION PROCEDURES .....1**  
**MILLENNIUM SYSTEM FINAL TEST.....5**  
**MODEL M10605 TEST DATA SHEET .....7**  
**MODEL M10600 TEST DATA SHEET .....8**

**TOOLS & TEST EQUIPMENT**

**SERVICE TOOLS & SUPPLIES .....1**  
**ACCEPTABLE TEST EQUIPMENT.....2**

**SCHEMATICS**

**SCHEMATICS STATEMENT.....1**

*This page intentionally left blank.*

## INTRODUCTION

This section provides an introduction to the Millennium Oxygen Concentrator devices as well as contact and service training information.

### CAUTION

*U.S. federal law restricts this device to sale by or on the order of a physician.*

## MILLENNIUM OXYGEN CONCENTRATOR OVERVIEW

The Millennium Oxygen Concentrator is intended to provide supplemental oxygen to persons requiring low flow oxygen therapy. This device is not intended to be life supporting nor life sustaining. The Millennium Oxygen Concentrator produces concentrated oxygen from room air for delivery to a patient. The oxygen from the air is concentrated using a molecular sieve and a pressure swing adsorption process.

## TYPES OF CONCENTRATORS

### **MILLENNIUM H600/H605 CONCENTRATORS**

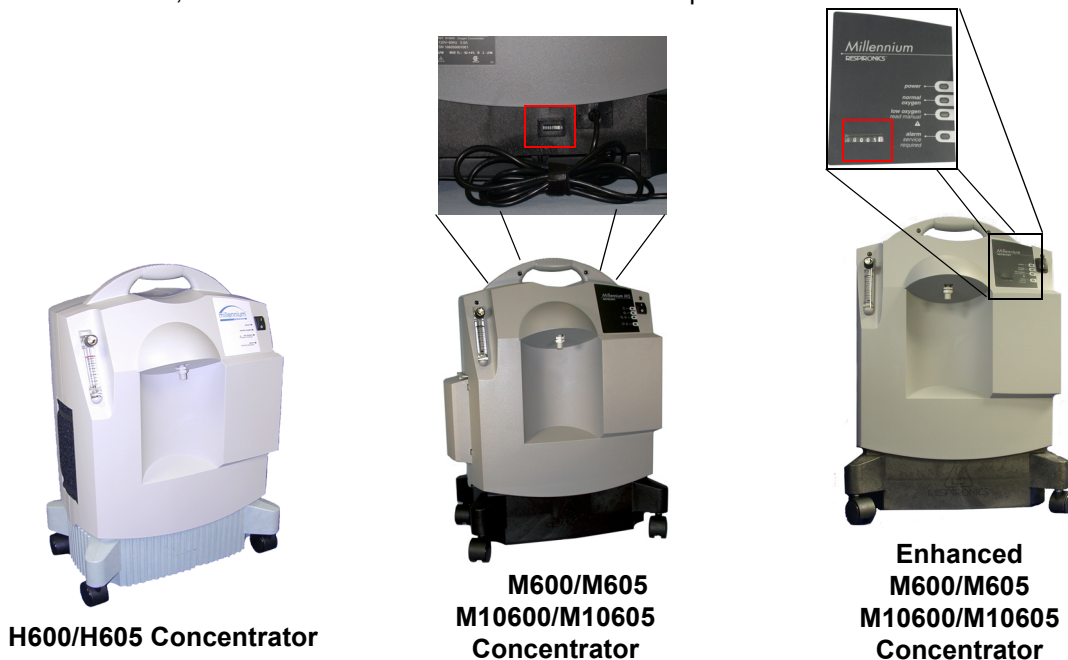
The Millennium H600/605 Concentrators are equipped with a green cabinet and a fluted Base Cabinet.

### **MILLENNIUM M600/M605/M10600/M10605 CONCENTRATORS**

The Millennium M600/M605/M10600/M10605 Concentrators comes equipped with a grey cabinet, a black Base Cabinet, and the Hour Meter is located in the Base Cabinet.

### **MILLENNIUM ENHANCED M600/M605/M10600/M10605 CONCENTRATORS**

The Millennium Enhanced M600/M605/M10600/M10605 Concentrators comes equipped with a grey cabinet, a black Base Cabinet, and the Hour Meter is located on the front panel of the Front Cabinet.





---

## **SERVICE NOTICE**

The Millennium is designed so that trained Service Technicians can perform repair and testing procedures. The information provided in this manual will allow service technicians to perform the service and maintenance required on the Millennium. The individual(s) using this manual should have prior training or experience servicing oxygen concentrators.

## **SERVICE TRAINING**

Respironics offers service training for the Millennium Concentrators. Training includes complete disassembly of the device, troubleshooting subassemblies and components, and performance testing. For more information, contact the Service Marketing department at:

**E-mail: [service.operations@respironics.com](mailto:service.operations@respironics.com)**

**Phone: (724) 755-8220**

**Fax: (724) 755-8230**

## **SERVICE/TECHNICAL SUPPORT STATEMENT**

For technical assistance, please contact Respironics Customer Service.

**U.S.A. and Canada**

**Phone: 1-800-345-6443**

**Fax: 1-800-886-0245**

**International**

**Phone: 1-724-387-4000**

**Fax: 1-724-387-5012**

## **WARNINGS & CAUTIONS**

### **SECTION OVERVIEW**

Warnings and Cautions, are used throughout this manual to identify possible safety hazards, conditions that may result in equipment or property damage, and important information that must be considered when performing service and testing procedures on the Millennium Oxygen Concentrators.

Please read this section carefully before servicing the Millennium Oxygen Concentrators.

#### **WARNING**

*Warnings indicate the possibility of injury to the patient, operator, or technician.*

#### **CAUTION**

*Cautions indicate the possibility of damage to the device*

#### **NOTE**

*Notes are used to emphasize a characteristic or important consideration.*

### **WARNINGS**

#### **WARNINGS**

- *Oxygen generated by this concentrator is supplemental and should not be considered life supporting or life sustaining. In certain circumstances, oxygen therapy can be hazardous; any user should seek medical advice prior to using this device.*
- *Where the prescribing physician has determined that an interruption in the supply of oxygen, for any reason, may have serious consequences to the user, an alternate source of oxygen should be available for immediate use.*
- *Keep the unit away from heat and/or open flame as oxygen greatly accelerates combustion.*
- *Do not smoke when the concentrator is operating or patient is using the oxygen.*
- *Do not use greases, oils, or any petroleum based solvent or cleaner on or near the unit.*
- *Use extreme caution when handling the Compressor Capacitor as it holds an electrical charge until it is properly discharged.*
- *Avoid handling the molecular sieve material. Respironics recommends the return of the Sieve Canister Assembly to Respironics for any service that involves sieve disposal.*
- *Never modify the Power Cord or use adapters, extension cords, etc. The unit is double insulated and uses a 2-prong not a 3-prong Power Cord. Any modification to the Power Cord could alter the safety feature.*

### WARNINGS (CONT'D)

- *A physician must prescribe use of a humidifier with the Millennium. Use of only bubble type humidifiers is recommended and connections must be secure and free of leaks.*
- *If the Millennium Oxygen Concentrator has been subjected to hot or cold temperatures for an extended period of time, it should be allowed to warm up to the stated operating temperatures before power up. Failure to do so could result in improper performance and or alarm conditions until the unit reaches normal operating temperatures.*
- *Do not turn on the unit while any filter is wet or moist.*

### CAUTIONS

#### CAUTIONS

- *U.S. federal law restricts this device to sale by or on the order of a physician.*
- *Place the unit where cooling airflow is unrestricted. Be sure to inform the user not to position the unit close to drapery or curtains that might restrict the airflow.*
- *When using a liquid leak detector, be careful not to allow it to contact electrical parts.*
- *Make sure connections of fittings, tubing, and hoses are secure.*
- *Be cautious when using thread sealants because they can cause extensive damage to the internal parts of the unit if allowed within tubing or fittings.*
- *Device operation above or outside of the Voltage, LPM, Temperature, Humidity and /or Altitude values specified in the manual may decrease oxygen concentration levels.*
- *Clean all exterior cabinet surfaces periodically by wiping with a damp cloth, using a mild detergent and/or hospital disinfectant.*
- *If the 25-foot tubing, connector, and high flow cannula supplied with the Millennium M10 Oxygen Concentrator are not used, 10 LPM of oxygen flow may not be achieved.*
- *Use only Respironics or factory-authorized replacement parts and accessories.*

### NOTES

#### NOTES

- *Make sure the Flow Meter is set at the patient's prescribed flow rate once patient circuitry is attached.*
- *Make sure there are no kinks in the user's oxygen tubing. If necessary, use a non-kink style delivery tube (unit will go into an audible and visual alarm if the tubing is kinked or the flowmeter is turned completely off).*



## **SPECIFICATIONS & FEATURES**

### **SECTION OVERVIEW**

This section identifies the specifications and features of the Millennium Oxygen Concentrator.





## H600/605, M600/605, & ENHANCED M600/605 SPECIFICATIONS

SPECIFICATIONS			
Input Voltage	120 VAC	230 VAC	230VAC
Input Frequency	60 Hz	50 Hz	50 Hz
Average Power Consumption	460W	420/480W	360W
Dimensions	18.9"(L) × 13.3" (W) × 26.8" (H) (48.0 x 33.78 x 68.07 cm)		
Weight	50 lbs, 22.7 kg	54 lbs, 24.7 kg	
Flow Rate	Variable from 0.5 to 5 lpm		
Oxygen Concentration*	<b>H600/605 M600/605 Enhanced M600/605 Concentrator</b> 92 ± 4% @ 5 lpm 94 ± 2% @ 2 lpm	<b>H600/H605 Concentrator</b> ≥ 92 @ .5 to 3 lpm ≥ 87 @ 4 lpm ≥ 89 @ 4 lpm** ≥ 87 @ 5 lpm**	<b>M600/605; Enhanced M600/605 Concentrator</b> 94 ± 2% @ 0.5 to 4 lpm 94 ± 4% @ 5 lpm <b>M605-70; Enhanced M605-70 Concentrator</b> 88 ± 4% @ 5 lpm
Oxygen Outlet Pressure (No Flow)	6.0 ± 1.0 psig		
Regulated Pressure @ 5 lpm	5.5 ± 0.25 psig		
Operating Pressure	70-186 kPa		
Operating Temperature	55-90° F (13-32° C)		
Storage/transport Temperature	-30-160° F (-34-71° C)		
Storage/transport Humidity Operating Humidity	Up to 95% non-condensing		
Storage/Transport Atmospheric Pressure	790-525 mm Hg		
Altitude	Up to 7,545 ft. Up to 2300 m		
Sound Pressure Level (dBA)	H600/605; M600/605; Enhanced M600/605 120V: 60Hz-49.8 dBA M600/605; Enhanced M600/605 230V (except M605-70): <43dBA M600/605; Enhanced M605-70: <40dBA H600/605 230V <42dBA		
* Oxygen concentration levels are for operation within specified temperatures and altitude ranges. Operation outside specified ranges may decrease oxygen concentration levels.  ** Specifications achieved only at the following operating parameters: 20 ° C (68 ° F), 50% relative humidity, and 1017 mbar.			

<b>SAFETY</b>	
<i>Pressure Relief Valve</i>	<i>40 ± 3 psig (303 ± 20.7 kPa)</i>
<i>Compressor Compartment Thermal Protection with Self Reset</i>	<i>149° F (65° C)</i>
<b>ALARM CONDITIONS</b>	
<i>Visual Red Light Emitting Diode (LED) and audible sound alert:</i>	
<ul style="list-style-type: none"> <li>• <i>Start-up test;</i></li> <li>• <i>Power failure;</i></li> <li>• <i>Main PCB failure; and</i></li> <li>• <i>High and low pressure</i></li> </ul>	
<i>Oxygen percentage indicator (Model 605 only): O<sub>2</sub> &lt; 70%</i>	
<b>ALERT CONDITIONS</b>	
<i>H600/605 Concentrators have a yellow visual LED with intermittent audible alarm and red LED:</i>	
<ul style="list-style-type: none"> <li>• <i>No oxygen flow</i></li> </ul>	
<i>Oxygen percentage indicator (model 605): 70% &lt; O<sub>2</sub> &lt; 85%</i>	
<i>M600/605; Enhanced M600/605 Concentrators have a yellow LED with intermittent audible alarm and red LED:</i>	
<ul style="list-style-type: none"> <li>• <i>No oxygen flow</i></li> </ul>	
<i>Oxygen percentage indicator (model 605): 70% &lt; O<sub>2</sub> &lt; 82%</i>	
<b>POWER INDICATION</b>	
<i>Visual, green LED (next to Power Switch).</i>	
<b>OXYGEN PERCENTAGE INDICATOR (MODEL 605)</b>	
<b><i>H605 Concentrators</i></b>	
<i>Warnings Conditions: Blinking yellow LED after unit is turned on and until O<sub>2</sub> &gt; 85%.</i>	
<i>Normal Oxygen: Visual green LED when O<sub>2</sub> &gt; 85%.</i>	
<b><i>M605; Enhanced M605 Concentrators</i></b>	
<i>Warnings Conditions: Blinking yellow LED after unit is turned on and until O<sub>2</sub> &gt; 82%.</i>	
<i>Normal Oxygen: Visual green LED when O<sub>2</sub> &gt; 82%.</i>	

## M10600/M10605 & ENHANCED M10600/M10605 SPECIFICATIONS

<b>SPECIFICATIONS</b>	
<i>Input Voltage</i>	120 VAC
<i>Input Frequency</i>	60 Hz
<i>Average Power Consumption</i>	600W
<i>Dimensions</i>	19"(L) × 13" (W) × 27" (H) (48.0 x 33.0 x 69.0 cm)
<i>Weight</i>	53 ± 0.5 lbs, (24 ± 0.23 kg)
<i>Flow Rate</i>	Variable from 1 to 10 lpm
<i>Oxygen Concentration*</i>	92 ± 4% @ 8 - 10 lpm 94 ± 2% @ 3 - 7 lpm 92 ± 4% @ 1 - 2 lpm
<i>Oxygen Outlet Pressure (No Flow)</i>	6.0 ± 1.0 psig
<i>Regulated Pressure @ 10 lpm</i>	5.5 ± 0.25 psig
<i>Operating Pressure</i>	10 - 30 psig
<i>Operating Temperature</i>	55-90° F (15-32° C)
<i>Storage/transport Temperature</i>	-30-160° F (-34-71° C)
<i>Storage/Transport/Operating Humidity</i>	Up to 95% non-condensing
<i>Storage/Transport Atmospheric Pressure</i>	790-525 mm Hg
<i>Altitude</i>	Up to 1,368 ft. Up to 417 m Verify flow and purity at higher altitudes.
<i>Sound Pressure Level (dBA)</i>	<50 dBA
* Oxygen concentration levels are for operation within specified voltages, lpm, temperatures and altitude ranges. Operation outside specified ranges may decrease oxygen concentration levels.	

<b>SAFETY</b>	
<i>Compressor Compartment Thermal Protection with Self Reset</i>	<i>149° F (65° C)</i>
<b>ALARM CONDITIONS</b>	
<i>Visual Red LED and audible sound alert:</i>	
<ul style="list-style-type: none"> <li>• <i>Start-up test;</i></li> <li>• <i>Power failure;</i></li> <li>• <i>Main PCB failure; and</i></li> <li>• <i>High and low pressure</i></li> </ul>	
<i>Oxygen percentage indicator (M10605): O<sub>2</sub> &lt;70%</i>	
<b>ALERT CONDITIONS</b>	
<i>Concentrators have a have a yellow visual LED with intermittent audible alarm and red LED:</i>	
<ul style="list-style-type: none"> <li>• <i>No oxygen flow</i></li> </ul>	
<i>Oxygen percentage indicator (M10605): 70% &lt;O<sub>2</sub>&lt; 82%</i>	
<b>POWER INDICATION</b>	
<i>Visual, green LED (below to Power Switch).</i>	
<b>OXYGEN PERCENTAGE INDICATOR (MODEL 605)</b>	
<i>Warnings Conditions: Blinking yellow LED after unit is turned on and until O<sub>2</sub> &gt; 82%.</i>	
<i>Normal Oxygen: Visual green LED when O<sub>2</sub> &gt; 82%.</i>	

## FRONT CABINET FEATURES

### ***FLOW METER***

Used to set and indicate amount of oxygen flowing from unit to patient. Adjustable from 0.5 to 5 or 10 lpm, depending on the concentrator.

### ***DISS OUTLET FITTING***

A male DISS fitting used to connect the mating connector from the humidifier bottle or the patient's cannula.

### ***POWER SWITCH***

Used to turn the device On and Off.

### ***CONTROL OVERLAY***

Indicates the red alarm light, the green ON light, and the Oxygen percentage (Model 605 and M10605 Only).

### ***HOURLY METER (ENHANCED M600/605; ENHANCED M10600/M10605 MODEL ONLY)***

Indicates cumulative hours of unit operation.

## REAR AND SIDE CABINET FEATURES

### ***SERIAL PLATE***

Lists model and serial numbers, requirements, and specifications.

### ***HOURLY METER (H600/605; M600/605; M10600/M10605)***

Indicates cumulative hours of unit operation.

### ***PRE-INLET FILTER***

Filters the air that enters the concentrator.

### ***REAR ACCESS DOOR***

Allows access to the following:

- Inlet pre-filter, inlet filter configuration, Silencer, or
- Long Life Filter Configuration (Enhanced M10600/M10605), and
- Battery

### ***POWER CORD***

Used to connect concentrator to AC power receptacle.

---

## CONTROL PANEL FEATURES

CONDITIONS	CAUSE
<i>AC Power</i>	<i>Solid Green LED</i>
<i>Normal Oxygen Condition</i>	<i>OPI units only (Model 605); solid green LED with no alarm sound</i>
<i>Low Oxygen Alert Condition with Red LED</i>	<i>Solid yellow LED with intermittent (every 2 seconds) audible alarm</i>
<i>Alarm Condition</i>	<i>Solid red LED and continuous audible</i>
<i>Start-up Test</i>	<i>Light all LED's and sound audible alarm for 2 seconds after power on</i>
<i>Warm-up Condition</i>	<i>OPI units only (Model 605); blinking yellow LED with no alarm sound.</i>

*This page intentionally left blank.*

## SYSTEM SETUP

### SECTION OVERVIEW

This section describes the procedures that should be performed prior to patient use and periodically to ensure proper setup and operation.

### SYSTEM SETUP

1. Remove the rear access door and verify that the proper filters are in place.
2. Ensure that filters are secure. Twist the filter while firmly pressing downwards.
3. Before connecting the unit to a power source, perform the following procedure to check battery condition and alarm function.
  - a. Move the Power Switch to the ON (I) position. The alarm should sound and the red LED should illuminate.
  - b. Move the Power Switch to the OFF (O) position. The alarm and the red LED light should go off.
4. Connect the Power Cord to a power source.
5. Turn on the unit by moving the Power Switch to the ON (I) position and verify the following:
  - all LED's illuminate and audible alarm sounds for two seconds;
  - the unit starts running; and
  - the green power LED remains illuminated.

#### NOTE

*If you have a Model 605, which is equipped with the oxygen percentage indicator (OPI), the yellow LED light will blink until the oxygen purity is above 85% for H600/605 Concentrators and above 82% for M600/605; Enhanced M600/605 Concentrators. The green normal oxygen LED illuminates, once appropriate O<sub>2</sub> purity is achieved.*

6. Adjust the Flow Meter to max. 5 or 10 lpm depending on the concentrator. Turning the Flow Meter clockwise decreases the flow, and turning it counter-clockwise increases the flow.
7. If the items above are working properly, proceed to step 8. If there is a problem refer to the Troubleshooting section.
8. Attach a calibrated Oxygen Analyzer to the DISS outlet fitting. The oxygen concentration should be as specified in the *Specifications* section.



*This page intentionally blank.*

## THEORY OF OPERATION

### SECTION OVERVIEW

This section describes the theory of operation for the Millennium Oxygen Concentrators.

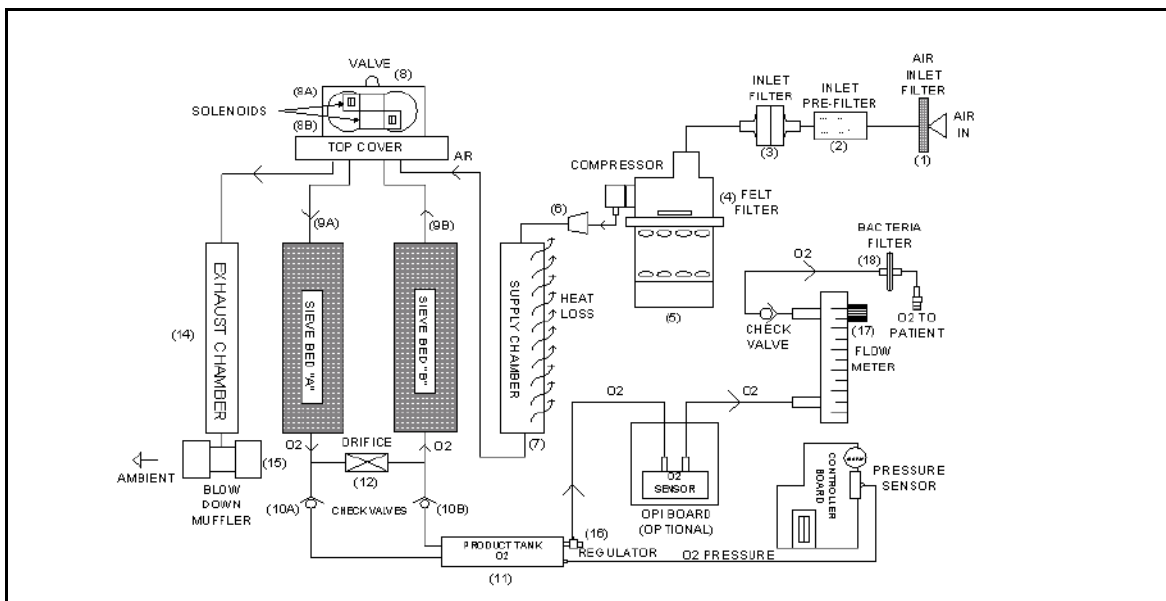
### H600/605; M600/605; ENHANCED M600/605 CONCENTRATOR PNEUMATIC OPERATION

Room air enters through a foam air inlet filter (1) mounted on the side of the cabinet. The primary system air is drawn through the inlet pre-filter, (2) the inlet filter (3) and then through the felt filter (4) by the Compressor (5). The exhaust air then passes through the In-line Muffler (6) to the supply chamber.

The Compressor exhaust air is cooled by the supply chamber (7) and distributed using a pneumatic Valve/Solenoid Assembly (8). At start up, valve (8) is de-energized allowing compressed air to flow into both Sieve Canisters (9) until the pressure sensor builds up to switching pressure. At switching pressure, a 12 volt signal is received at Valve/Solenoid(8a) closing the input and allowing compressed air to continue through sieve bed (9a) for 6.25 seconds absorbing the Nitrogen and allowing the Oxygen to flow through check valve (10a) and into the product tank (11).

At 5 liters of flow approximately 1/3 of the Oxygen is deposited into the product tank and 2/3 is passed through orifice (12) in to sieve bed (9b) to purge the Nitrogen from the sieve bed, which exits through the exhaust port of the Valve/Solenoid(8b) to exhaust chamber (14) through Blow Down Muffler (15) to outside air in a time of 6.25 seconds.

At the end of this cycle the unit will balance for 1 second which de-energizes valve / solenoid (8b) and allows compressed air to flow into both Sieve Canisters. The pressure reaches the max switching pressure and sends a 12 volt signal to valve / solenoid (8b) and the adsorption cycle starts over in the Sieve Canister (9b). Oxygen is in a continuous flow from the product can (11) through the regulator (16) through the Flow Meter (17) to the bacteria filter (18) to the patient.



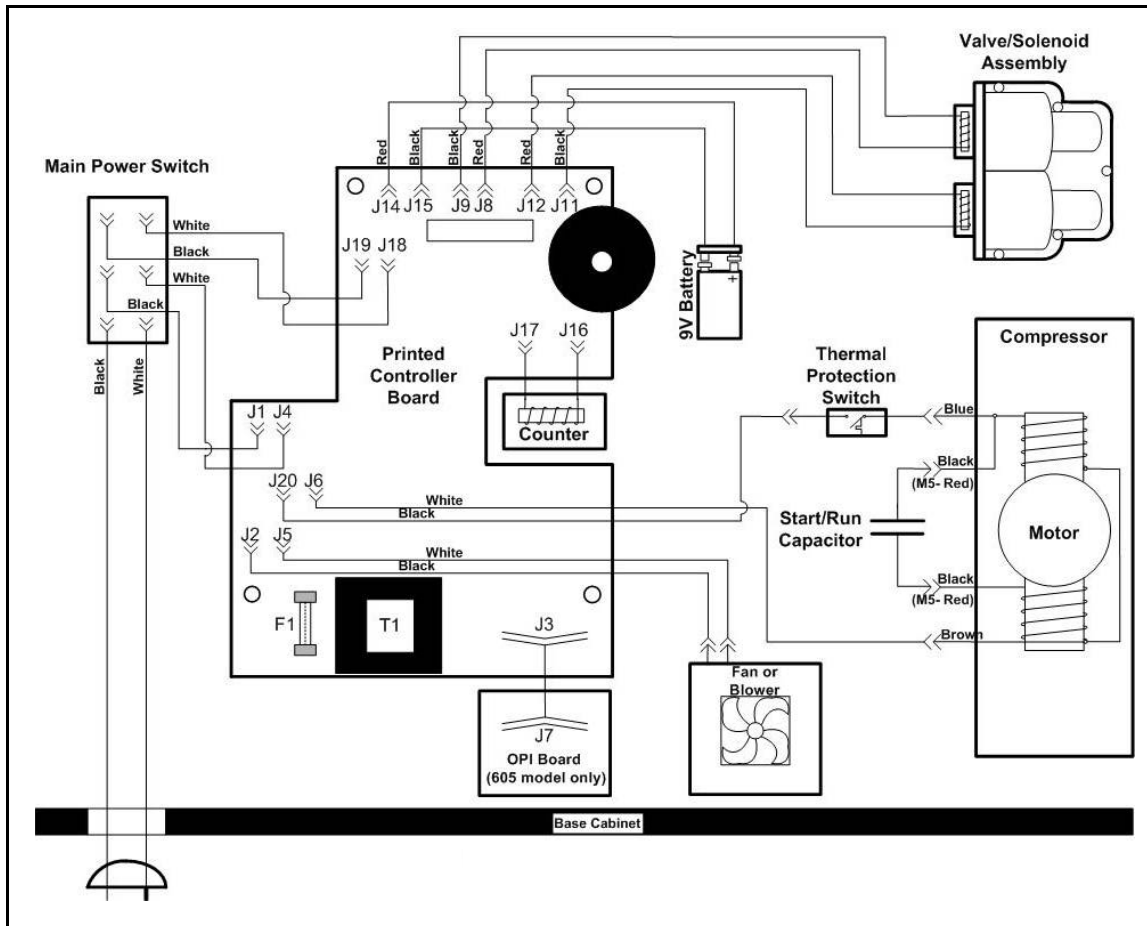
**FIGURE A: H600/605; M600/605; ENHANCED M600/605 PNEUMATIC BLOCK DESIGN**

## H600/605; M600/605; ENHANCED M600/605 CONCENTRATOR ELECTRICAL OPERATION

Power is supplied from the two-prong plug to the Power Switch. When the Power Switch is ON, 120 VAC/230 VAC power is supplied to the Compressor motor, Hour Meter, cooling fan, and the main circuit board.

The main circuit board consists of a linear power supply, pressure sensor, software driven microprocessor, green, yellow, and red LED's and audible alarm.

The 9-volt battery provides a power source to operate the audible alarm and the red LED alarm light in the event of an AC power failure.



**FIGURE B: H600/605; M600/605; ENHANCED M600/605 ELECTRONIC COMPONENT BLOCK DIAGRAM**

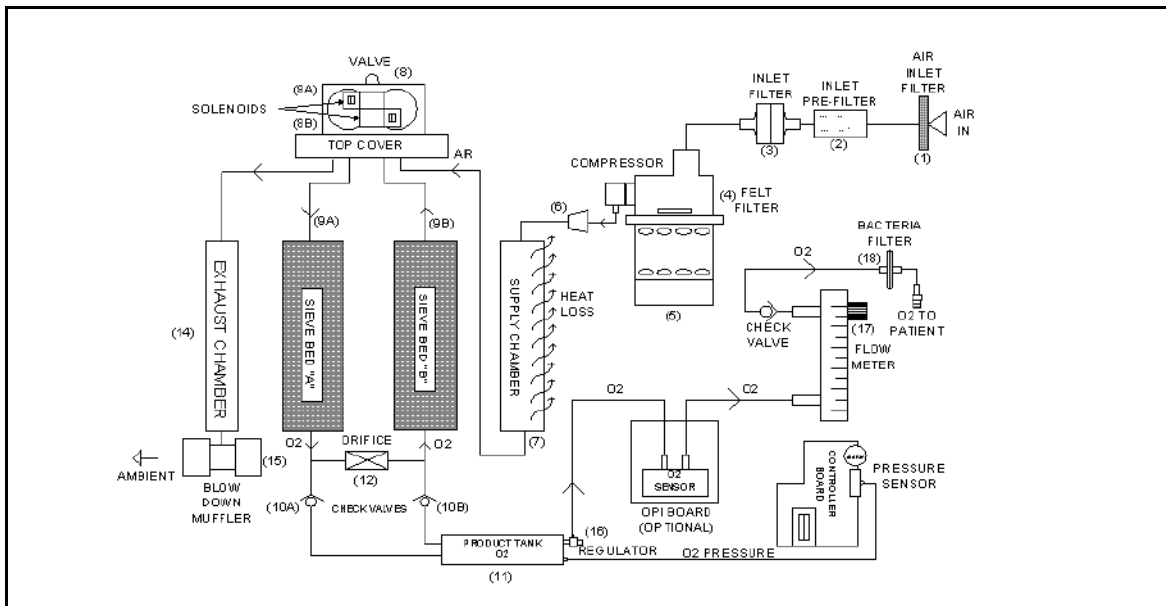
## M10600/M10605; ENHANCED M10600/M10605 CONCENTRATOR PNEUMATIC OPERATION

Room air is drawn through a foam air inlet filter (1) mounted on the side of the cabinet. The primary system air is drawn through the inlet pre-filter, (2) the inlet filter w/ silencer (3) by the Compressor (5). The exhaust air then passes through the In-line Muffler (6) to the supply chamber.

The Compressor exhaust air is cooled by the supply chamber (7) and distributed using a pneumatic Valve/Solenoid Assembly (8). At start up, valve (8) is de-energized allowing compressed air to flow into both Sieve Canisters (9) until the pressure sensor builds up to switching pressure. At switching pressure, a 12 volt signal is received at Valve/Solenoid(8a) closing the input and allowing compressed air to continue through sieve bed (9a) for 6.25 seconds absorbing the Nitrogen and allowing the Oxygen to flow through check valve (10a) and into the product tank (11).

At 5 liters of flow approximately 1/3 of the Oxygen is deposited into the product tank and 2/3 is passed through orifice (12) in to sieve bed (9b) to purge the Nitrogen from the sieve bed, which exits through the exhaust port of the Valve/Solenoid(8b) to exhaust chamber (14) through Blow Down Muffler (15) to outside air in a time of 6.25 seconds.

At the end of this cycle the unit will balance for 1 second which de-energizes valve / solenoid (8b) and allows compressed air to flow into both Sieve Canisters. The pressure reaches the max switching pressure and sends a 12 volt signal to valve / solenoid (8b) and the adsorption cycle starts over in the Sieve Canister (9b). Oxygen is in a continuous flow from the product can (11) through the regulator (16) through the Flow Meter (17) to the bacteria filter (18) to the patient.



**FIGURE C: M10600/M10605; ENHANCED M10600/M10605 PNEUMATIC BLOCK DESIGN**



## MAINTENANCE

This section describes the scheduled and routine maintenance procedures. The maintenance procedures must be performed on the Millennium Oxygen Concentrator System as part of the normal care of the unit.

Maintenance is very important in prolonging dependability and in reducing costly repairs. Long-term maintenance and regular checking of the filters helps assure the efficient operation of the unit. The user should be instructed on how to clean the accessible filters. An authorized technician should perform all other maintenance.

### MAINTENANCE INTERVALS

#### ***WEEKLY USER MAINTENANCE***

Weekly user maintenance consists of inspecting and cleaning the Inlet Filter.

#### ***DEALER ANNUAL MAINTENANCE***

Annual maintenance shall be performed by the Home Care Dealer, or at a Respironics service facility. Annual maintenance includes the following.

- Checking the condition of the Filters (change if necessary).
- Cleaning the cabinet.
- Verifying the oxygen concentration with a calibrated oxygen analyzer. This procedure must be performed once a year or between patients. Refer to the Testing Section for more detail.
- Perform a power interrupt alarm test, and replace the 9-volt battery if necessary. Refer to the Testing Section for more detail.
- Perform a start-up LED and audible alarm test. Refer to the Testing Section for more detail.

#### **NOTE**

*For units equipped with the Long Life Filter, Respironics recommends checking and replacing the Long Life Filter every two (2) years. For all other Maintenance follow the Dealer Annual Maintenance Guidelines listed above.*

## **DEALER PERIODIC MAINTENANCE**

Periodic maintenance shall be performed by the Home Care Dealer, or at a Respiroics service facility. Periodic maintenance includes the following:

- Checking the final patient bacteria filter and replacing if necessary.
- Measuring the product canister pressure.

### **NOTE**

*If the product canister pressure is lower than normal, but the unit has clean filters and no leaks, then Compressor maintenance should be performed.*

## **DEALER COMPRESSOR MAINTENANCE**

### **NOTE**

*The Compressor can be returned to the Compressor manufacturer to be recertified.*

Compressor maintenance shall be performed by the Home Care Dealer, or at a Respiroics service facility. Compressor maintenance is required by Respiroics to prolong dependability of the concentrator. However, the need for this maintenance varies depending on the operating conditions and the environment where the unit is used. Some signs of poor Compressor performance are:

- low oxygen readings,
- low pressure readings, and
- increased noise level.

Compressor maintenance shall be performed at intervals commensurate with hospital or home care provider guidelines. Compressor Maintenance includes the following:

### **A. CLEANING THE AIR INLET FILTER**

1. Remove the Air Inlet Filter from the side of the unit.
2. Vacuum or wash the Air Inlet Filter with a mild detergent and tap water.
3. If washed, allow the Air Inlet filter to air dry completely before installing it on the unit.



**FIGURE A: LOCATION OF THE AIR INLET FILTER**

## **B. CLEANING THE PRE-INLET FILTER & INLET FILTER**

1. Remove the rear access door from the unit.



**FIGURE B: REMOVING THE REAR ACCESS DOOR**

2. Remove the Pre-inlet Filter and the Inlet Filter from the unit.
3. Remove the Pre-inlet Filter from the Inlet filter.



**FIGURE C: FILTER LOCATIONS**

4. Wash the foam Pre-inlet Filter with a mild detergent and tap water. Allow it to air dry completely.
5. Inspect the Inlet filter and replace if necessary.
6. Place the assembled filters on the filter cover. While firmly pressing down on the filter assembly, turn the filter assembly clock-wise to assure of a tight fit between the filter assembly and the filter cover.
7. Install the rear access door.



**C. CLEANING THE CABINET**

1. Disconnect the unit from the power source.
2. Using a mild detergent and disinfectant, clean all exterior surfaces of the cabinet.

**CAUTION**

*Do not allow any liquid to enter the unit.*

3. Ensure that the cabinet is dry before placing in service.

**D. MICRO-DISK FILTER MAINTENANCE**

The Micro-disk filter is the final component in the filtering system before the concentrated oxygen is delivered to the patient. Check and replace this filter as necessary.

<b>PART NUMBER: H621</b>	
<b>Included in Kit</b>	<b>Tools Required</b>
Micro-disk Filter (x6) Wire Ties (x2)	Phillips Screwdriver (No. 2 Medium w/ long shaft) Diagonals (wire cutters)

**Procedure**

**WARNING**

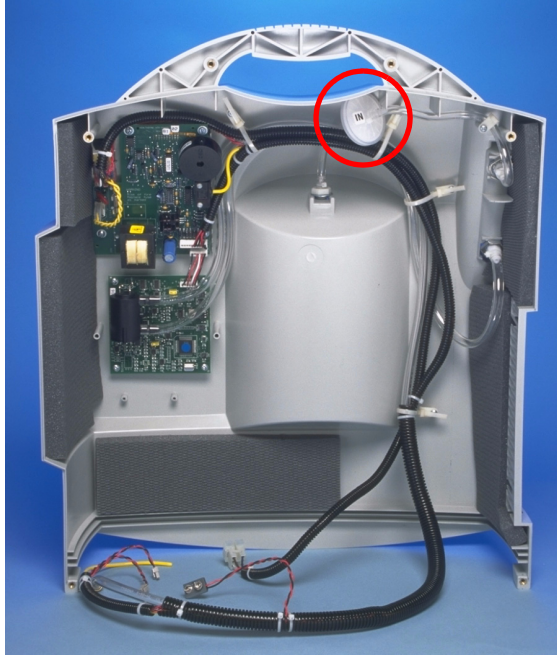
*Electrical shock hazard; Disconnect the electrical supply before attempting to make any repairs.*

**CAUTION**

*Electronic components used in this device are subject to damage from static electricity. Repairs made to this device must be performed only in an antistatic, ESD protected environment.*

1. Remove the Rear Cabinet.

2. Remove the Front Cabinet, and separate it from the unit.



**FIGURE D: MICRO-DISK FILTER LOCATION**

3. Using the diagonals, cut the wire ties that secure the pressure tubing to the Micro-disk filter.
4. Remove the pressure tubing from the inlet and outlet ports of the Micro-disk filter.
5. Slide the pressure tubing onto the inlet and outlet ports of the new Micro-disk filter.
6. Using the wire ties provided, secure the pressure tubing to the new Micro-disk filter.
7. Use the diagonals to cut off the excess from the wire ties.

**E. H00/605 (120V/230V); M600/605 (120V); ENHANCED M600/605 (120V) COMPRESSOR MAINTENANCE**

<b>PART NUMBER: H610</b>	
<b>Included in Kit</b>	<b>Tools Required</b>
<ul style="list-style-type: none"> <li>• <i>Piston Cup</i></li> <li>• <i>Piston cup retainer</i></li> <li>• <i>Valve keeper / restraint (exhaust)</i></li> <li>• <i>Valve keeper (intake)</i></li> <li>• <i>Cylinder Sleeve</i></li> <li>• <i>Valve flapper (exhaust)</i></li> <li>• <i>Valve flapper (intake)</i></li> <li>• <i>O-ring (sleeve)</i></li> <li>• <i>O-ring (intake filter cover)</i></li> <li>• <i>Gasket (valve plate)</i></li> <li>• <i>Cork gasket</i></li> <li>• <i>Filter (felt)</i></li> <li>• <i>Screw (valve keeper x2)</i></li> <li>• <i>Screw (piston cup retainer x4)</i></li> <li>• <i>In-line Muffler (molded fittings)</i></li> <li>• <i>Clamp (one ear x3)</i></li> <li>• <i>Hose (3/8 ID Braided)</i></li> </ul>	<ul style="list-style-type: none"> <li>• <i>Millennium Screwdriver (RI p/n H646)</i></li> <li>• <i>Flat blade screwdriver (medium)</i></li> <li>• <i>T-15, T-20, T-25 Torx bits (Included with Millennium screwdriver)</i></li> <li>• <i>Torque wrench, 30 in.-lbs (RI p/n 1033057)</i></li> <li>• <i>One Ear Clamp Pliers (RI p/n H645)</i></li> </ul>

**NOTE**

*Respironics requires that all components of the Compressor maintenance kit be used to ensure that the Compressor will function properly after Compressor maintenance has been performed.*

**WARNING**

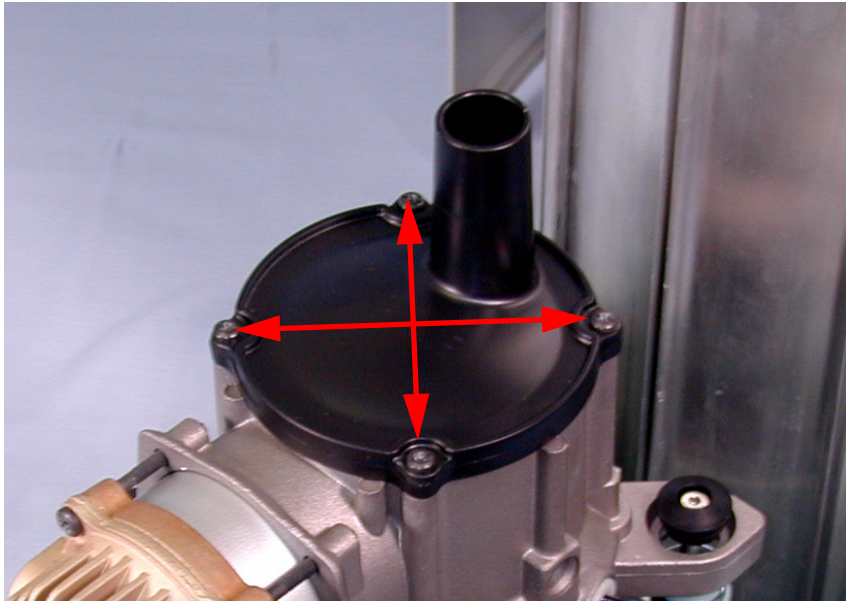
*Electrical shock hazard; Disconnect the electrical supply before attempting to make any repairs to the device.*

**CAUTION**

*Electronic components used in this device are subject to damage from static electricity. Repairs made to this device must be performed only in an antistatic, ESD-protected environment.*

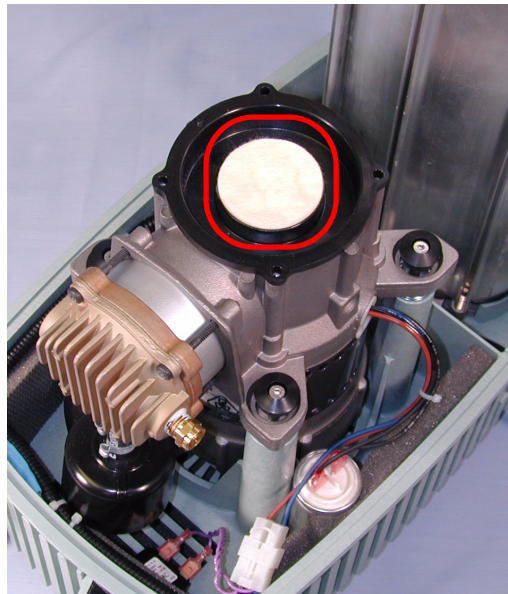
## Procedure

1. Remove the Rear Cabinet. Refer to the proper *Repair & Replacement* section for detailed instructions.
2. Remove the Front Cabinet. Refer to the proper *Repair & Replacement* section for detailed instructions.
3. Remove the Compressor Cover/ Perforated Canopy. Refer to the proper *Repair & Replacement* section for detailed instructions.
4. Remove the four screws securing the filter cover using a T-20 or 7/64 Torx bit.



**FIGURE E: SCREW LOCATION**

5. Remove and replace the felt filter inside the filter cover.



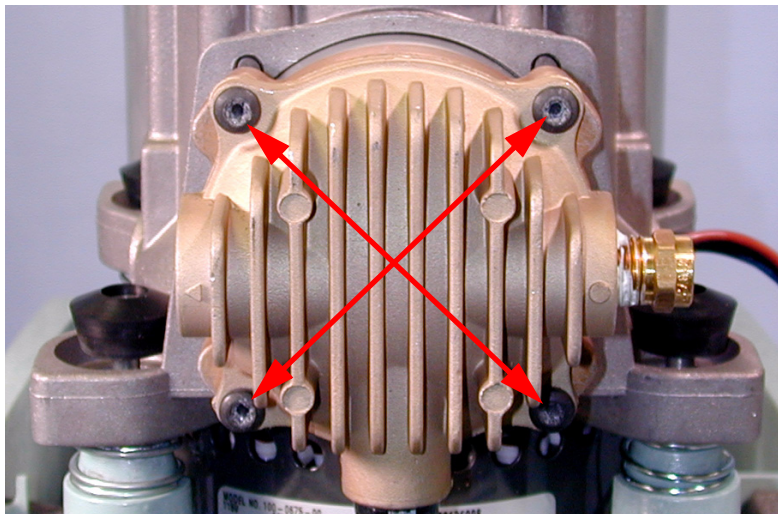
**FIGURE F: FELT FILTER**

6. Remove and replace the O-ring on the bottom side of the filter body.



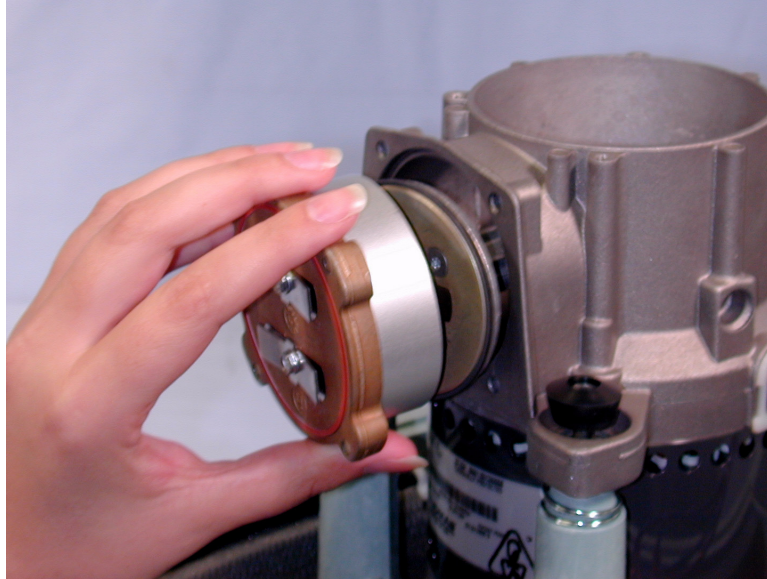
**FIGURE G: O-RING LOCATION**

7. Remove the four screws securing the Compressor head using a T-25 or 1/8 Torx bit.



**FIGURE H: COMPRESSOR HEAD SCREW LOCATIONS**

8. Remove the valve plate and cylinder sleeve.



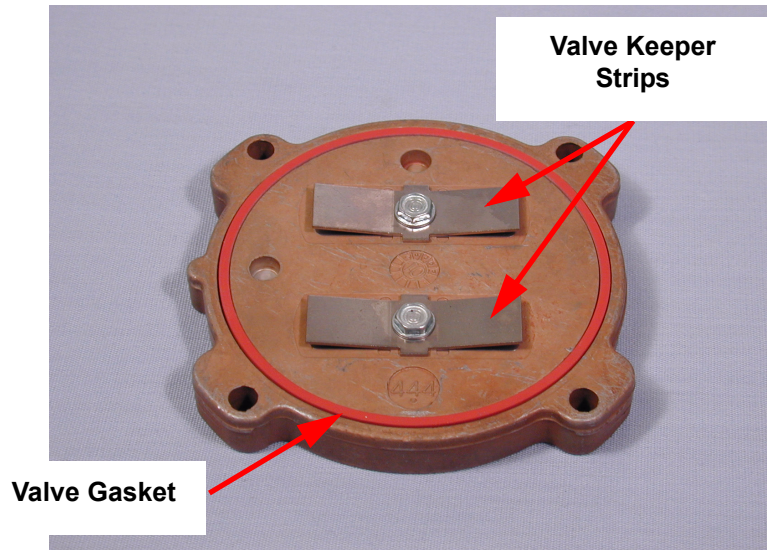
**FIGURE I: REMOVING THE VALVE PLATE AND CYLINDER SLEEVE**

9. Separate the cylinder sleeve from the valve plate, and discard the sleeve and O-ring.



**FIGURE J: SEPARATING THE CYLINDER SLEEVE AND VALVE PLATE**

10. Remove the screws, and replace the valve flappers on the valve plate using a 1/4 in. nut driver.



**FIGURE K: FLAPPER VALVE REMOVAL**

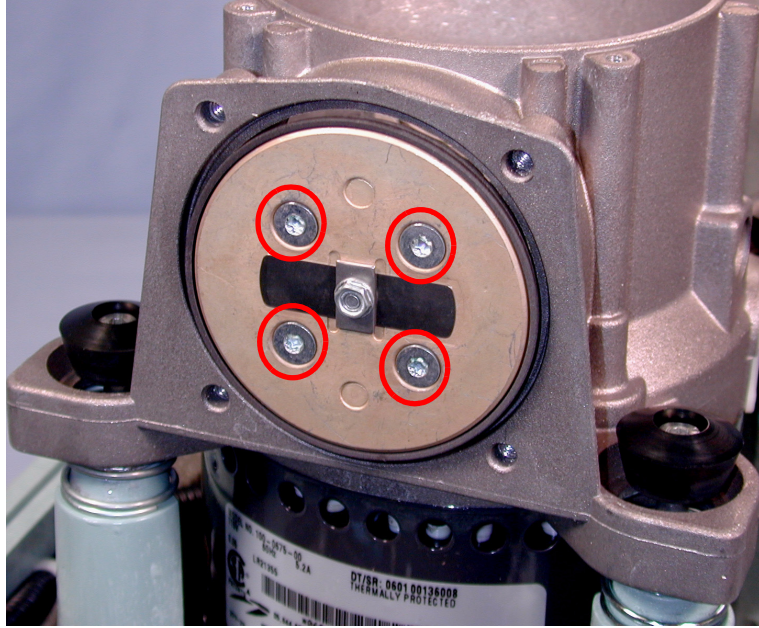
**NOTE**

*The Valve flappers are located under the keeper strips.*

11. Remove and replace the gasket on the valve plate.
12. Using a T-20 torx bit, remove and discard the four screws, the piston cup, the retainer plate and the cork gasket from the connecting rod assembly.

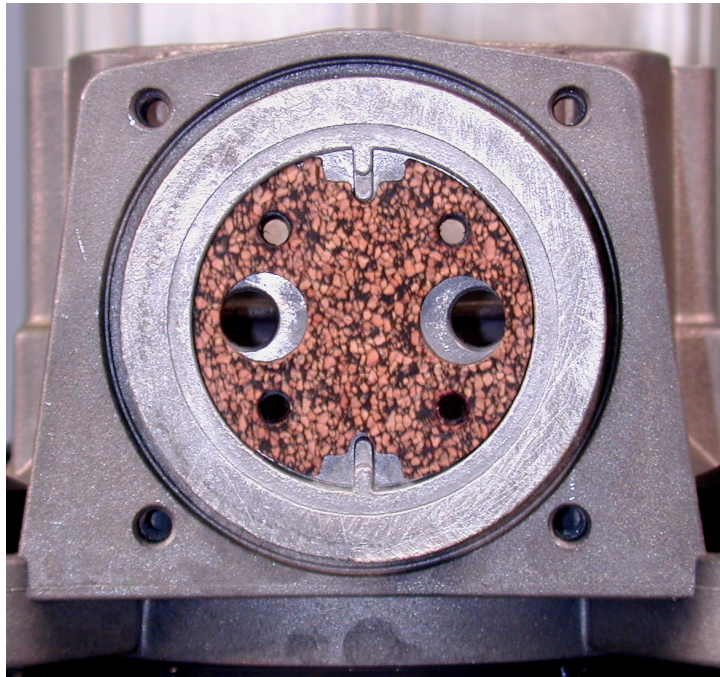
**NOTE**

*A heat gun may be used to loosen the loctite on the screws.*



**FIGURE L: LOCATION OF THE PISTON CUP RETAINER SCREWS**

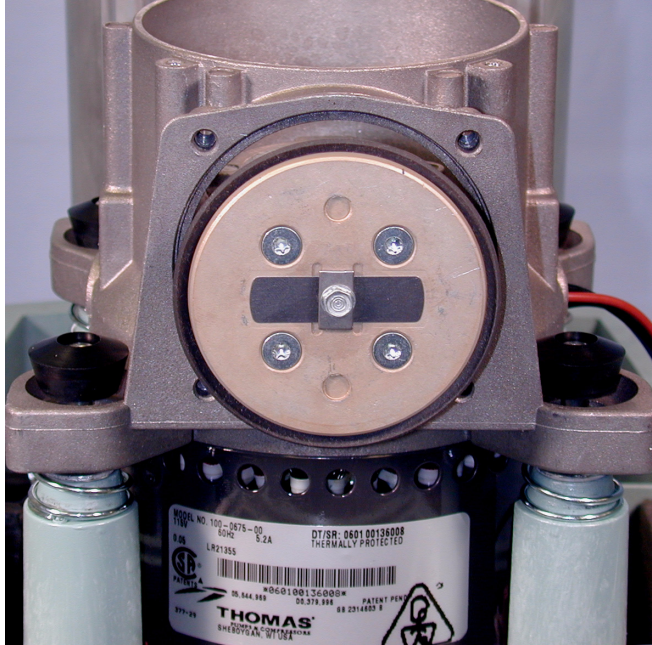
13. Place the new cork gasket on the connecting rod assembly, making sure the cork fits around the pins on the connecting rod assembly.



**FIGURE M: INSTALLING THE CORK GASKET**

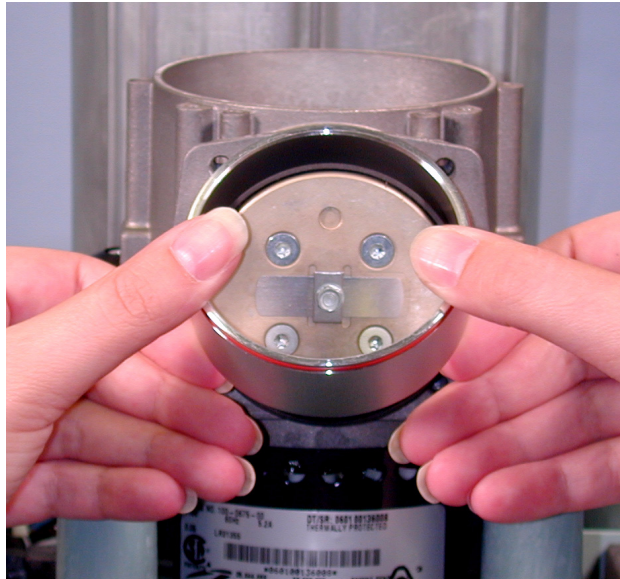


14. Place the new piston cup on the back of the new retainer plate. Using the new screws provided, secure the retainer to the connecting rod assembly and torque screws to 30 in.-lbs.

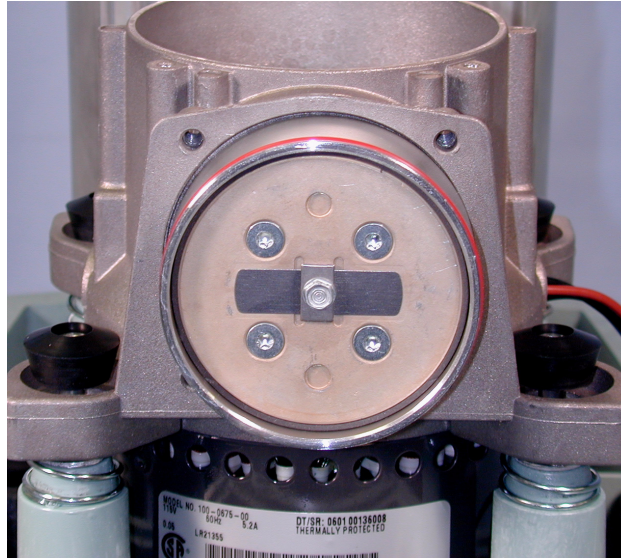


**FIGURE N: INSTALLING THE PISTON CUP & RETAINER**

15. Set the new sleeve in place with the O-ring away from the piston. Slide the sleeve down over the piston cup using your fingers to guide the sleeve without damaging the piston cup.

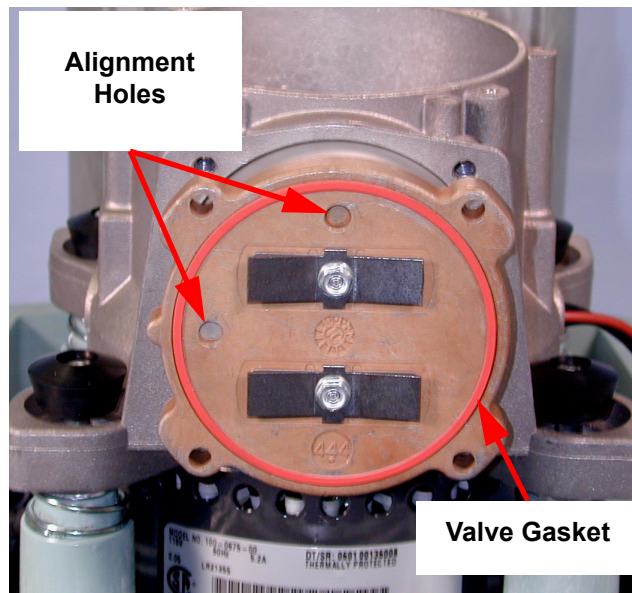


**FIGURE O: INSTALLING THE CYLINDER SLEEVE**



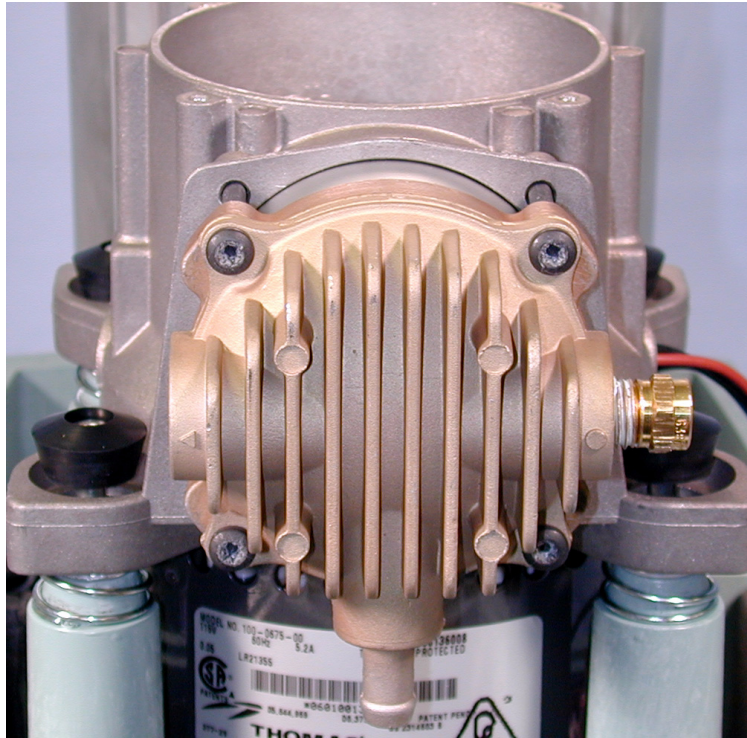
**FIGURE P: CYLINDER SLEEVE IN PLACE**

16. Press the valve plate onto the cylinder sleeve making sure not to pinch the O-ring on the cylinder sleeve. The valve plate must be positioned properly to ensure proper alignment with the Compressor head. Place the valve gasket in the groove of the valve plate.



**FIGURE Q: VALVE GASKET & ALIGNMENT HOLES**

17. Place the Compressor head onto the valve plate. Using a T-25 Torx bit and a torque wrench, tighten the Compressor head bolts to 30 in.-lbs.



**FIGURE R: COMPRESSOR HEAD IN PLACE**

18. Place the new Felt filter and the O-ring on the Intake filter body.
19. Connect the In-line Muffler to the bottom of the Compressor head and secure with a clamp.



**M600/605 (230V); ENHANCED M600/605 (230V); M10600/M10605; ENHANCED M10600/M10605 COMPRESSOR MAINTENANCE**

<b>PART NUMBER: 1018249</b>		
<b>Included in Kit</b>	<b>Tools Required</b>	<b>Applicable Concentrator</b>
<ul style="list-style-type: none"> <li>• <i>Piston Cup (x2)</i></li> <li>• <i>Cylinder Sleeve (x2)</i></li> <li>• <i>Cylinder O-ring (x2)</i></li> <li>• <i>Head Screws (x8)</i></li> <li>• <i>Head Gasket (x2)</i></li> <li>• <i>Cup Retainer Screws (x2)</i></li> <li>• <i>Valve Restraint (x2)</i></li> <li>• <i>Valve Keeper (x4)</i></li> <li>• <i>Valve (x4)</i></li> <li>• <i>Valve Screw (x4)</i></li> <li>• <i>Dynamic Backer (x2)</i></li> </ul>	<ul style="list-style-type: none"> <li>• <i>Millennium Screwdriver (w/bits) (RI p/n H646)</i></li> <li>• <i>Cutting Pliers</i></li> <li>• <i>Heat Gun (acceptable ranges, 200°F thru 900°F)</i></li> <li>• <i>3/8" Drive Hex Bit Holder (RI p/n 1040446)</i></li> <li>• <i>1/4" Drive Hex bit holder (RI p/n 1033058)</i></li> <li>• <i>Torque Wrench, 18in-lbs (RI p/n 1018495)</i></li> <li>• <i>Torque Wrench, 55 in-lbs (RI p/n 1018490)</i></li> <li>• <i>Torque Wrench, 100 in-lbs (RI p/n 1024064)</i></li> <li>• <i>Torque Wrench, 125 in-lbs (RI p/n 1024062)</i></li> <li>• <i>1/8" Allen wrench or Hex bit</i></li> <li>• <i>5/32" Allen Wrench or Hex bit</i></li> <li>• <i>T-25 and T-27 Torx bit</i></li> <li>• <i>Vice</i></li> <li>• <i>Socket wrench</i></li> <li>• <i>Soft cloth</i></li> <li>• <i>One Ear Clamp Pliers (RI p/n H645)</i></li> </ul>	<ul style="list-style-type: none"> <li>• <i>M10600/M10605</i></li> <li>• <i>Enhanced M10600/M10605</i></li> </ul>

PART NUMBER: 1015569		
Included in Kit	Tools Required	Applicable Concentrator
<ul style="list-style-type: none"> <li>• Piston Cup (x2)</li> <li>• Cylinder Sleeve (x2)</li> <li>• Cylinder O-ring (x2)</li> <li>• Head Screws (x8)</li> <li>• Head Gasket (x2)</li> <li>• Cup Retainer Screws (x2)</li> <li>• Valve Restraint (x2)</li> <li>• Valve Keeper (x4)</li> <li>• Valve (x4)</li> <li>• Valve Screw (x4)</li> <li>• Instruction Sheet</li> <li>• Dynamic Backer (x2)</li> </ul>	<ul style="list-style-type: none"> <li>• Millennium Screwdriver (w/bits) (RI p/n H646)</li> <li>• Cutting Pliers</li> <li>• Heat Gun (acceptable ranges, 200°F thru 900°F)</li> <li>• 3/8" Drive Hex Bit Holder (RI p/n 1040446)</li> <li>• 1/4" Drive Hex bit holder (RI p/n 1033058)</li> <li>• Torque Wrench, 18in-lbs (RI p/n 1018495)</li> <li>• Torque Wrench, 55 in-lbs (RI p/n 1018490)</li> <li>• Torque Wrench, 100 in-lbs (RI p/n 1024064)</li> <li>• Torque Wrench, 125 in-lbs (RI p/n 1024062)</li> <li>• 1/8" Allen wrench or Hex bit</li> <li>• 5/32" Allen Wrench or Hex bit</li> <li>• T-25 and T-27 Torx bit</li> <li>• Vice</li> <li>• Socket wrench</li> <li>• Soft cloth</li> <li>• One Ear Clamp Pliers (RI p/n H645)</li> </ul>	<ul style="list-style-type: none"> <li>• M600/605 230V</li> <li>• Enhanced M600/M605 230V</li> </ul>

**NOTE**

*Respironics requires that all components of the Compressor maintenance kit be used to ensure that the Compressor will function properly after Compressor maintenance has been performed. It is also recommended that the In-line Muffler be replaced (RI p/n 1018460)*

**WARNING**

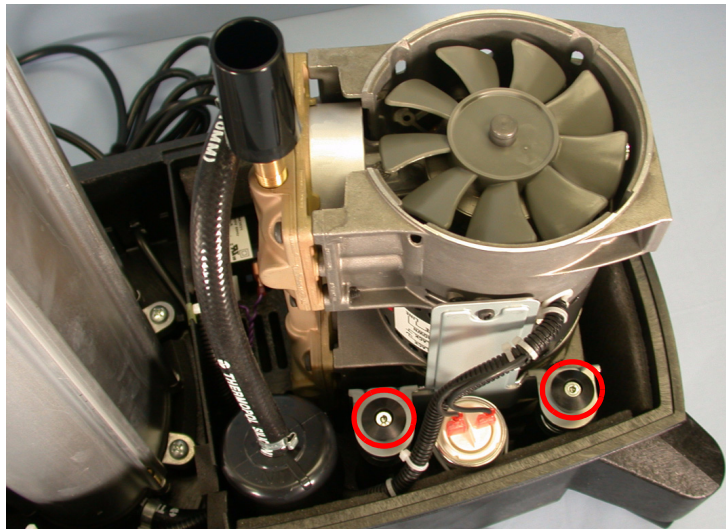
*Electrical shock hazard; Disconnect the electrical supply before attempting to make any repairs to the device.*

**CAUTION**

*Electronic components used in this device are subject to damage from static electricity. Repairs made to this device must be performed only in an antistatic, ESD-protected environment.*

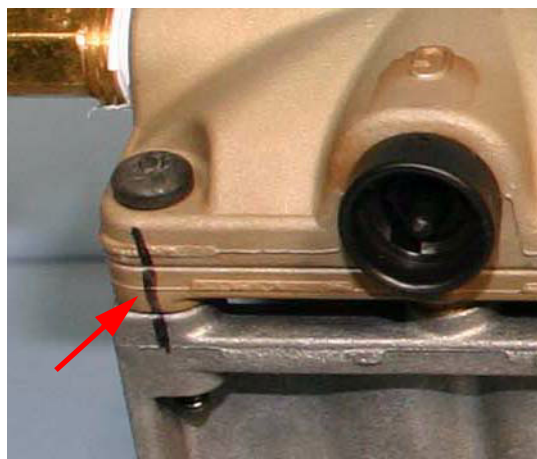
## Procedure

1. Remove the Rear Cabinet. Refer to the proper *Repair & Replacement* section for detailed instructions.
2. Remove the Front Cabinet. Refer to the proper *Repair & Replacement* section for detailed instructions.
3. Remove the Compressor Cover/ Perforated Canopy. Refer to the proper *Repair & Replacement* section for detailed instructions.
4. Disconnect the exhaust tubing, Capacitor wires and input power wiring from the Compressor assembly.
5. Using a 1/8" Allen wrench or 1/8" Hex bit, remove the four Compressor mounts.



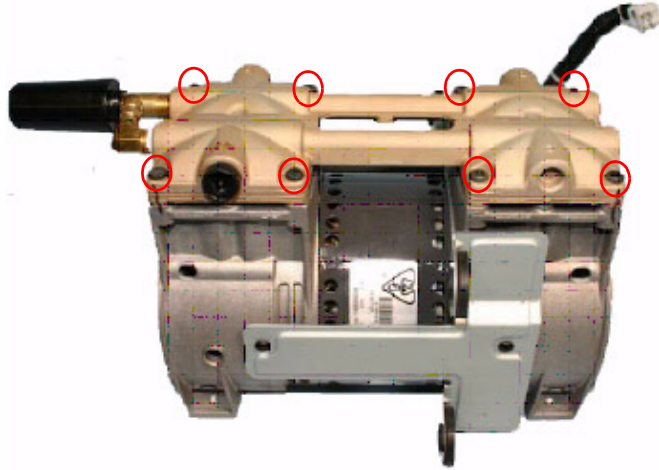
**FIGURE S: COMPRESSOR MOUNTS (2 OF 4 SHOWN)**

6. Lift the Compressor assembly out of the Millennium Base.
7. Before disassembly, mark the outside corners on one side of the Compressor to ensure proper valve plate and Compressor head orientation during reassembly.



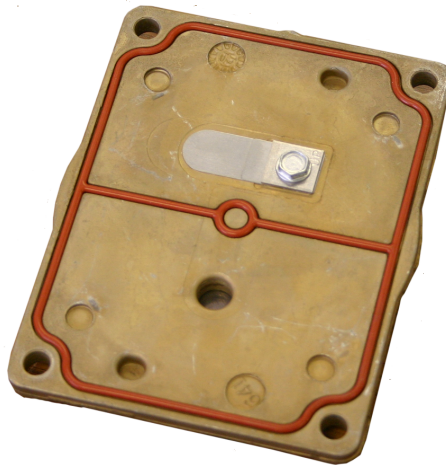
**FIGURE T: CORNER MARKINGS**

8. Remove the eight screws securing the Compressor head cover using a T-25 Torx bit or flathead screwdriver. Remove the Compressor head cover.



**FIGURE U: SCREW LOCATIONS**

9. Remove both valve plates from the Compressor.



**FIGURE V: VALVE PLATE**

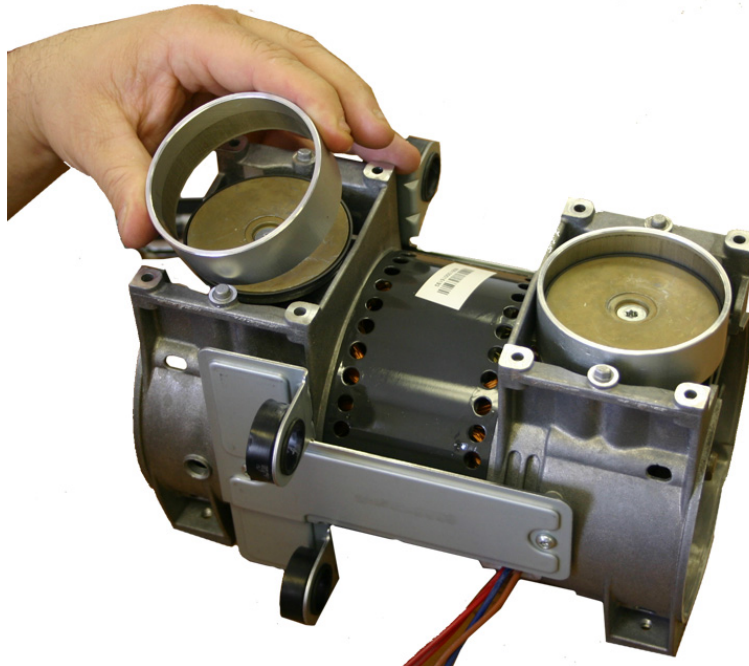
10. Remove the flapper screw from the Compressor head side of the valve plate. Take note of the cut-outs on the flapper. The new flapper must be placed in the same fashion during assembly. Discard the old flapper, keeper, restraint, and gasket.
11. Clean the plate with a soft cloth. Install the new flapper. Place the new restraint on top of the flapper. The keeper should be placed on top of the restraint so the word "UP" is visible. Tighten the flapper screw to 18 in-lbs. Install the new gasket.
12. Perform this procedure on the second valve plate.

13. Turn the valve plate over to the cylinder side.



**FIGURE W: CYLINDER SIDE OF VALVE PLATE**

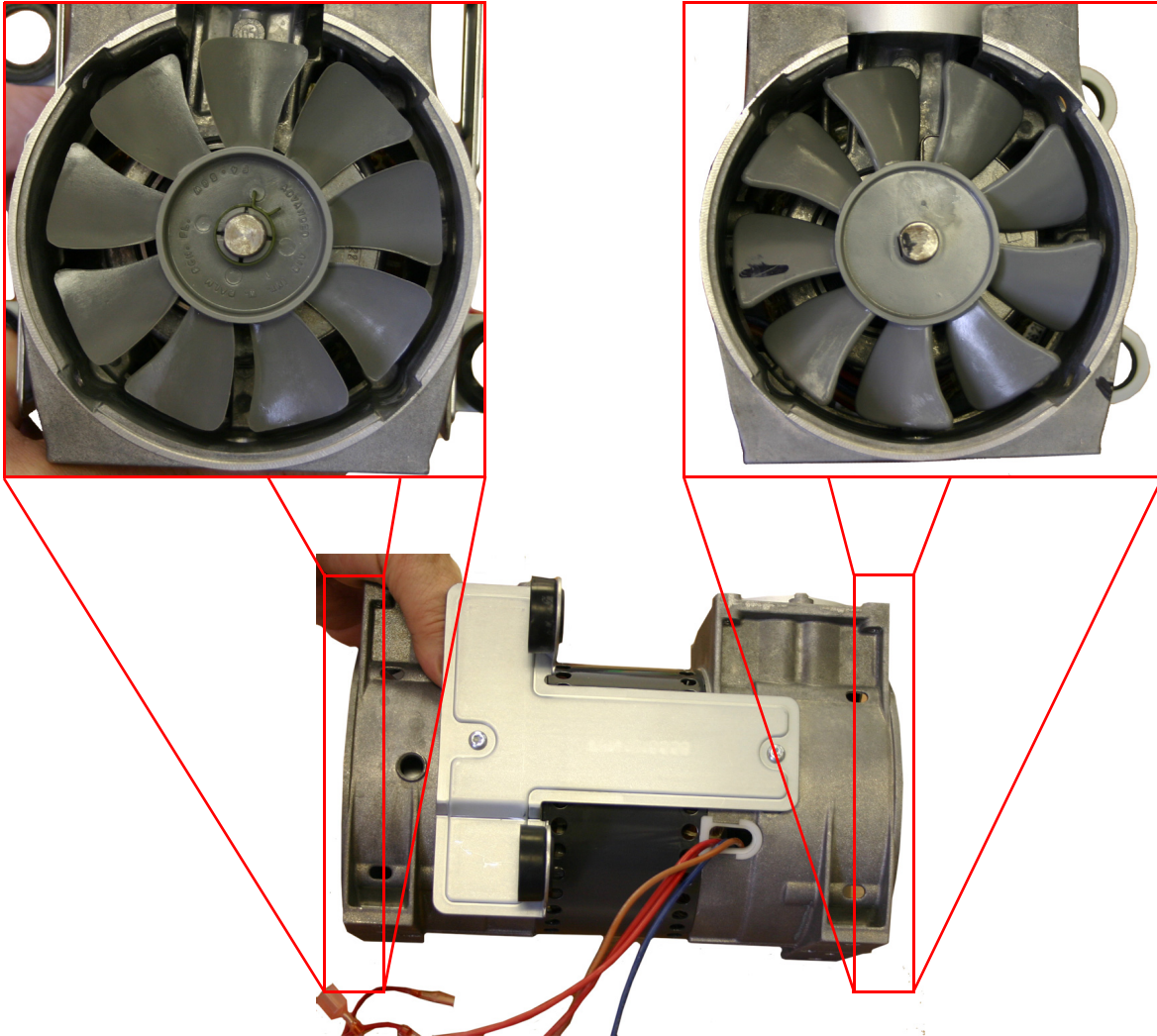
14. Remove the flapper screw. Once again, ensure to note the flapper cutouts before disassembly. Discard the flapper keeper and O-ring.
15. Clean the plate with a clean cloth.
16. Install the new flapper. Place the keeper on top of the flapper so that the word "UP" is visible. Tighten the screw to 18 in-lbs. Install the new O-ring.
17. Perform this procedure on the second valve plate and set aside the valve plates.
18. Remove and discard both cylinder sleeves.



**FIGURE X: REMOVING THE CYLINDER SLEEVE**



19. Use Figure Y as a reference to ensure proper fan orientation.



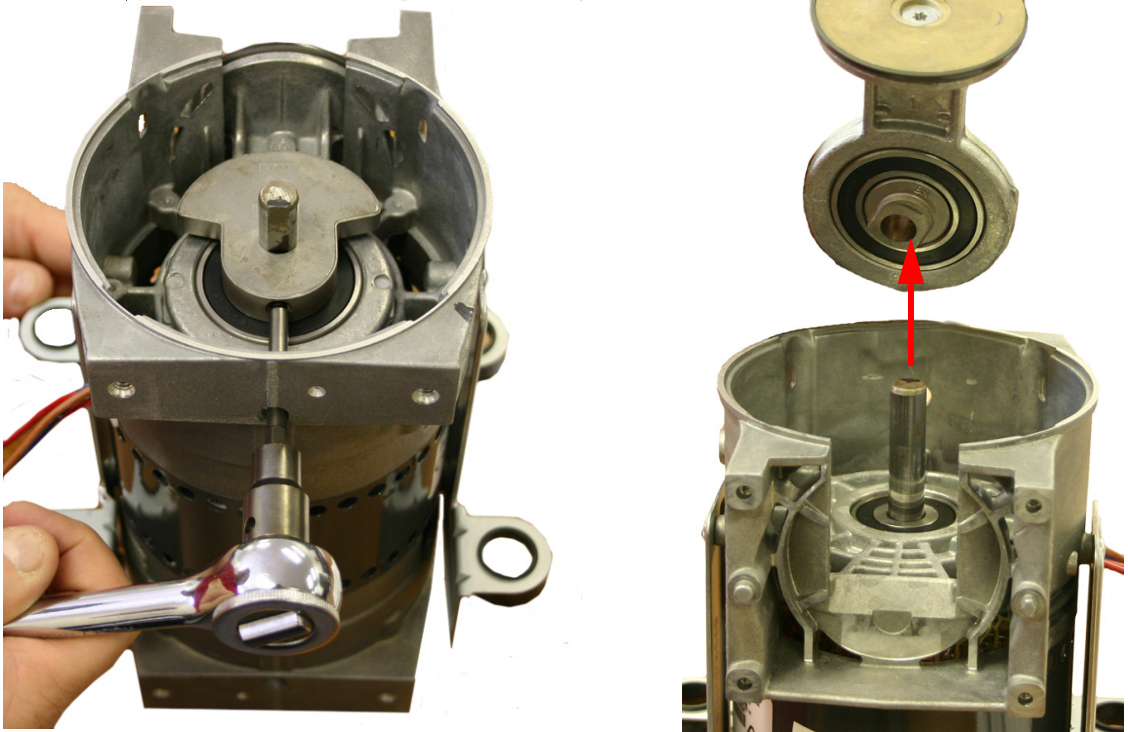
**FIGURE Y: PROPER FAN ORIENTATION**

20. Pull upwards from the center of the fan. It may be necessary to rock the fan back and forth while pulling upwards to remove it from the shaft.

## CAUTION

*Do not attempt to pull up on the outside edges of the fan blades.*

21. To remove the connecting rod assembly from the shaft, rotate the eccentric until the set screw lines up with the Compressor housing access hole. Insert the 5/32" Allen wrench or hex bit through the access hole and loosen the set screw 1/4 turn. Rotate the eccentric to top dead center (180°), and slide the connecting rod/eccentric assembly off of the shaft.



**FIGURE Z: REMOVING THE ECCENTRIC**

22. Wrap the neck of the connecting rod assembly with a cloth, and secure the assembly in a vice being cautious not to clamp down on the eccentric and or bearings.



**FIGURE AA: CONNECTING ROD ASSEMBLY IN VICE**

## NOTE

*Considerable care must be taken while removing the piston cup retainer screw. The screw has been tightened to 100 in-lbs with Loctite® on the threads and may become stripped if not removed properly.*

23. Heat the screw with a heat gun for approximately one minute.



**FIGURE AB: HEATING THE SCREW**

## CAUTION

*During this procedure, parts will become hot. Do not touch any parts with your bare hands. Use pliers to handle the parts until they have cooled.*

24. Connect the T-27 Trox bit to the socket wrench. Press down on the wrench and turn counter clockwise to loosen the screw. If the screw does not start to turn or the bit begins to slip, reapply heat for one minute. Continue this process until the screw is removed. Once the parts have cooled, discard the piston cup and screw.



**FIGURE AC: SCREW REMOVAL**

25. Place a new cylinder sleeve over the piston head. Place a new piston cup on the back of the cup retainer plate. Note the locations of the alignment pin on the back of the plate and the alignment hole on the piston head.



**FIGURE AD: REPLACE PISTON CUP**

26. Press the plate into the cylinder sleeve being careful not to crimp the piston cup. Once the plate is seated on top of the piston, rotate the plate until the plate pin seats into the piston alignment hole. Tighten the new T-27 plate screw to 100 in-lbs. Remove the rod assembly from the vice.
27. With the eccentric side of the connecting rod/eccentric assembly facing away from the Compressor, slide the assembly onto the shaft until the assembly is flush against the motor assembly.

Rotate the eccentric until the set screw lines up with the housing access hole. Rotate the shaft until the flat side of the shaft aligns with the set screw, and tighten the screw to 125 in-lbs.

28. Slide the fan onto the shaft until the fan is flush against the eccentric. Note the reference mark you made on the fan blade in step 19 of this procedure.
29. Turn over the Compressor for access to the second connecting rod/eccentric assembly. Repeat Steps 19 through Step 28.
30. Place the valve plates on the cylinders (O-ring side face down). The marks that were made before disassembly must be aligned. Check the valve gaskets for proper alignment.
31. Place the Compressor head on top of the plates so that the marks align in the corners. Install the head screws and tighten the screws to 55 in-lbs.

#### NOTE

*If replacing the In-line Muffler, perform muffler replacement before installing the Compressor.*

32. Place the Compressor on the mounts in the Base Cabinet. Make sure the springs are seated properly.
33. Align the holes of the Compressor assembly with the standoffs in the Base Cabinet. Ensure proper orientation of the Compressor assembly. Tighten the mounts to the base.
34. Reconnect the tubing to the Compressor exhaust port.
35. Reconnect the Compressor wires to the Capacitor and input power wiring. Proceed with final testing.



**MILLENNIUM OXYGEN CONCENTRATOR MAINTENANCE RECORD**

Model Number: \_\_\_\_\_

Serial Number: \_\_\_\_\_

Date Purchased: \_\_\_\_\_

DATE HOURS LPM	FILTERS				COMPRESSOR	
	<i>Air Inlet<sup>1</sup></i>	<i>Pre-Inlet<sup>2</sup></i>	<i>Inlet<sup>2</sup></i>	<i>Micro-disk</i>	<i>Compressor Rebuild</i>	<i>In-line Muffler</i>
<i>Record at each check</i>	<i>Clean and replace as needed</i>				<i>Check and perform maintenance as recommended</i>	

9V BATTERY <sup>2</sup>	OXYGEN CONCENTRATION <sup>2</sup>	OPI	MOTOR START/ RUN CAPACITOR
<i>Check and replace as needed</i>	<i>Check Level</i>	<i>Check lights at start up</i>	<i>Check and replace as recommended</i>

**NOTE**

<sup>1</sup> Patients should be instructed to position the unit so that proper ventilation for the unit is maintained, and to clean the air inlet filter weekly.

<sup>2</sup> Respironics requires that routine maintenance be performed annually.

*This page intentionally left blank.*

## TROUBLESHOOTING

### SECTION OVERVIEW

This section is intended to help the service technician determine what is wrong with the Millennium Oxygen Concentrator System. This section should also be used to determine what parts, if any, need to be replaced.

SYMPTOM	CAUSE	VERIFICATION	CORRECTIVE ACTION
<ul style="list-style-type: none"> <li>Pressure relief valve activating</li> <li>Low pressure alarm</li> </ul>	<p><b>Canister to Compressor tubing failure</b></p> <ul style="list-style-type: none"> <li>Tubing disconnected, kinked, or hole in tubing</li> </ul>	<ul style="list-style-type: none"> <li>Verify the tubing between the canister and Compressor is connected</li> <li>Verify the tubing is not kinked or pinched</li> <li>Verify there are no holes in the tubing</li> </ul>	<ul style="list-style-type: none"> <li>Reconnect the tubing</li> <li>Reposition the tubing</li> <li>Replace the tubing</li> </ul>
<ul style="list-style-type: none"> <li>Audible and visual alarm</li> <li>Pressure relief valve activating</li> </ul>	<p><b>Fuse Fails</b></p> <ul style="list-style-type: none"> <li>Open fuse on Main PCB</li> </ul>	<ul style="list-style-type: none"> <li>Verify the audible and visual alarm due to battery</li> </ul>	<ul style="list-style-type: none"> <li>Replace the fuse</li> </ul>
<ul style="list-style-type: none"> <li>Fluctuations in oxygen pressure</li> <li>Fluctuations in flow ball</li> </ul>	<p><b>Pressure regulator failure</b> Component failure</p>	<ul style="list-style-type: none"> <li>Verify the flow from regulator is correct</li> <li>Perform Oxygen Outlet/Regulated Pressure Test</li> </ul>	<ul style="list-style-type: none"> <li>Replace the regulator</li> </ul>
<p><b>Unit will not turn on</b></p> <ul style="list-style-type: none"> <li>Audible alert (steady)</li> <li>Red LED on (steady)</li> </ul>	<ul style="list-style-type: none"> <li>No power to the unit</li> </ul>	<ul style="list-style-type: none"> <li>Verify the Power Cord is connected to the wall outlet</li> <li>Verify there is power in the wall outlet</li> <li>Verify if the outlet is connected to a light switch and the switch is in the ON position</li> </ul>	<ul style="list-style-type: none"> <li>Connect the Power Cord to the wall outlet</li> <li>Check the household fuse or circuit breaker</li> <li>Move the Power Switch to the ON position</li> </ul>



SYMPTOM	CAUSE	VERIFICATION	CORRECTIVE ACTION
<p><b>Unit will not alarm (Red LED)</b></p> <ul style="list-style-type: none"> <li>• Power Cord is connected</li> <li>• Power Switch in the ON position</li> <li>• No Audible Alert</li> <li>• No Red LED</li> </ul>	<ul style="list-style-type: none"> <li>• No power to the alarm</li> </ul>	<ul style="list-style-type: none"> <li>• Verify the battery voltage is 5 volts or higher</li> <li>• Verify the battery connector is correctly seated on the battery</li> <li>• Verify the wiring harness is connected to the Power Switch</li> <li>• Verify the wiring harness is connected to the Main PCB</li> </ul>	<ul style="list-style-type: none"> <li>• Replace the 9 volt battery</li> <li>• Connect the wiring harness</li> <li>• Connect the wiring harness</li> <li>• Connect the wiring harness</li> <li>• Replace the Main PCB</li> </ul>
<p><b>LED failure (Models 600 and 605)</b></p> <ul style="list-style-type: none"> <li>• Red LED inoperable</li> <li>• Green LED inoperable</li> <li>• Yellow LED inoperable</li> </ul>	<ul style="list-style-type: none"> <li>• No power to LEDs</li> </ul>	<ul style="list-style-type: none"> <li>• Verify the Power Cord is plugged in</li> <li>• Verify the battery voltage is greater than 5 volts</li> <li>• Verify that all wiring harnesses are connected</li> <li>• Verify the Main PCB is not damaged</li> <li>• Verify the OPI board is not damaged (Model 605 only)</li> </ul>	<ul style="list-style-type: none"> <li>• Connect the Power Cord to AC power source</li> <li>• Replace the 9 volt battery</li> <li>• Connect all wiring harnesses</li> <li>• Replace the Main PCB</li> <li>• Replace the OPI board</li> </ul>

SYMPTOM	CAUSE	VERIFICATION	CORRECTIVE ACTION
<ul style="list-style-type: none"> <li>Unit is inoperable</li> </ul>	<p><b>Main PCB failure</b></p> <ul style="list-style-type: none"> <li>Intermittent power up</li> <li>High/Low pressure alarm</li> <li>No power</li> </ul>	<ul style="list-style-type: none"> <li>Verify the wiring harnesses are connected</li> <li>Verify the wiring harness is not damaged</li> <li>Verify the condition of the fuse on Main PCB</li> <li>Verify the solder joints are not faulty on Main PCB</li> <li>Verify there are no component failures on Main PCB</li> </ul>	<ul style="list-style-type: none"> <li>Connect the wiring harnesses</li> <li>Check the wiring harnesses for continuity</li> <li>Test the fuse for electrical continuity</li> <li>Replace the Main PCB</li> <li>Replace the Main PCB</li> </ul>
<ul style="list-style-type: none"> <li>Start-up-alarms inoperable</li> </ul>	<p><b>Piezoelectric speaker failure</b></p> <ul style="list-style-type: none"> <li>No audible alarm</li> </ul>	<ul style="list-style-type: none"> <li>Verify the wiring harnesses are connected</li> <li>Verify the solder joints are not faulty on the Main PCB</li> <li>Verify there are no component failures on the Main PCB</li> </ul>	<ul style="list-style-type: none"> <li>Reconnect the wiring harnesses</li> <li>Replace the Main PCB</li> <li>Replace the OPI PCB</li> <li>Replace the Main PCB</li> </ul>
<ul style="list-style-type: none"> <li>No audible or visual alarm while turning Power Switch On with the Power Cord unplugged</li> </ul>	<p><b>Battery Failure</b></p> <ul style="list-style-type: none"> <li>No audible or visual alarm during power-off.</li> </ul>	<ul style="list-style-type: none"> <li>Verify the battery is connected</li> <li>Verify the battery voltage is greater than 5 VDC</li> <li>Verify the wiring harness has continuity</li> </ul>	<ul style="list-style-type: none"> <li>Connect the battery</li> <li>Replace the 9 volt battery</li> <li>Replace wire harness, O<sub>2</sub>/solenoid/battery</li> </ul>

<b>SYMPTOM</b>	<b>CAUSE</b>	<b>VERIFICATION</b>	<b>CORRECTIVE ACTION</b>
<ul style="list-style-type: none"> <li>• <i>Low pressure alarm</i></li> </ul>	<p><b>Compressor failure</b></p> <ul style="list-style-type: none"> <li>• <i>Fluctuating or no oxygen production</i></li> </ul>	<ul style="list-style-type: none"> <li>• <i>Verify the thermal switch is not open</i></li> <li>• <i>Verify if the Compressor need to be rebuilt</i></li> <li>• <i>Verify if the In-line Muffler is cracked</i></li> </ul>	<ul style="list-style-type: none"> <li>• <i>Replace wire harness, main power (blower)</i></li> <li>• <i>Rebuild the Compressor</i></li> <li>• <i>Replace the Compressor</i></li> <li>• <i>Replace In-line Muffler</i></li> </ul>
<ul style="list-style-type: none"> <li>• <i>High pressure alarm</i></li> </ul>	<p><b>Pressure relief valve</b></p> <ul style="list-style-type: none"> <li>• <i>Relief valve activated</i></li> </ul>	<ul style="list-style-type: none"> <li>• <i>Verify the tubing is not kinked or pinched</i></li> <li>• <i>Verify the tubing is not damaged</i></li> <li>• <i>Verify the valve wiring harness is connected at the Main PCB and valve</i></li> </ul>	<ul style="list-style-type: none"> <li>• <i>Reposition the tubing</i></li> <li>• <i>Replace the damaged tubing</i></li> <li>• <i>Reconnect wire harness</i></li> <li>• <i>Replace the pressure relief valve</i></li> </ul>
<ul style="list-style-type: none"> <li>• <i>Low oxygen output</i></li> <li>• <i>Oxygen percentage indicator alarm (Model 605)</i></li> </ul>	<p><b>Sieve bed contaminated</b></p> <ul style="list-style-type: none"> <li>• <i>Low or no oxygen production</i></li> </ul>	<ul style="list-style-type: none"> <li>• <i>Verify the oxygen output with an oxygen analyzer</i></li> <li>• <i>Verify the Compressor is working properly</i></li> </ul>	<ul style="list-style-type: none"> <li>• <i>Replace the Sieve Canister</i></li> <li>• <i>Rebuild or replace the Compressor</i></li> </ul>
<ul style="list-style-type: none"> <li>• <i>Oxygen percentage indicator not functioning</i></li> <li>• <i>Continuous red LED</i></li> </ul>	<p><b>OPI power control board failure</b></p> <ul style="list-style-type: none"> <li>• <i>Oxygen output readings out of calibration</i></li> </ul>	<ul style="list-style-type: none"> <li>• <i>Verify all wiring harnesses are connected</i></li> <li>• <i>Verify there are no faulty solder joints on OPI</i></li> <li>• <i>Verify the OPI voltage outputs and compare with OPI Voltage Verification Chart (Model 605)</i></li> </ul>	<ul style="list-style-type: none"> <li>• <i>Connect all wiring harnesses</i></li> <li>• <i>Replace the OPI board</i></li> <li>• <i>Replace the OPI board</i></li> </ul>

<b>SYMPTOM</b>	<b>CAUSE</b>	<b>VERIFICATION</b>	<b>CORRECTIVE ACTION</b>
<ul style="list-style-type: none"> <li>• High pressure alarm</li> <li>• Low pressure alarm</li> <li>• Oxygen percentage indicator</li> <li>• Pressure relief valve activated</li> </ul>	<p><b>Valve/Solenoid failure</b></p> <ul style="list-style-type: none"> <li>• Low oxygen production</li> <li>• No oxygen production</li> <li>• Supply pressure too high</li> </ul>	<ul style="list-style-type: none"> <li>• verify the solenoid is working</li> <li>• Verify the pilot valve is working</li> <li>• Verify the main valve is working</li> <li>• Verify all wiring harnesses are connected</li> <li>• Verify the Compressor is working correctly</li> </ul>	<ul style="list-style-type: none"> <li>• Replace the valve/solenoid</li> <li>• Replace the valve/solenoid</li> <li>• Replace the valve/solenoid</li> <li>• Reconnect the wiring harnesses</li> <li>• Rebuild the Compressor</li> <li>• Replace the Compressor</li> </ul>
<ul style="list-style-type: none"> <li>• Low pressure alarm</li> </ul>	<p><b>Sieve Canister leaking</b></p> <ul style="list-style-type: none"> <li>• Reduced or no oxygen production</li> </ul>	<ul style="list-style-type: none"> <li>• Verify there are no loose screws on the Sieve Canister Assembly</li> <li>• Verify there are no blown gaskets on the Sieve Canister Assembly</li> </ul>	<ul style="list-style-type: none"> <li>• Tighten the hardware</li> <li>• Replace the Sieve Canister</li> </ul>
<p><b>Cooling fan failure</b></p> <ul style="list-style-type: none"> <li>• Warm cabinet temperature</li> </ul>	<ul style="list-style-type: none"> <li>• Thermal switch open</li> </ul>	<ul style="list-style-type: none"> <li>• Verify the cooling fan electrical connectors are seated</li> <li>• Verify there is continuity on electrical fan wiring harness</li> <li>• Verify there is power to the cooling fan</li> <li>• Verify the cooling fan bearings are not worn</li> <li>• Verify the cooling fan is not obstructed</li> </ul>	<ul style="list-style-type: none"> <li>• Reseat the connectors</li> <li>• Replace the wiring harness Main Power</li> <li>• Reseat the connectors</li> <li>• Replace the fan assembly</li> <li>• Remove the obstructions from the cooling fan</li> </ul>

SYMPTOM	CAUSE	VERIFICATION	CORRECTIVE ACTION
<ul style="list-style-type: none"> <li>False alarms</li> </ul>	<p><b>Oxygen pressure transducer failure</b></p> <ul style="list-style-type: none"> <li>Inaccurate or no pressure readings</li> </ul>	<ul style="list-style-type: none"> <li>Verify the pressure tubing is not damaged</li> <li>Verify there are no faulty solder joints on the Main PCB</li> <li>Verify there are no component failures on the Main PCB</li> </ul>	<ul style="list-style-type: none"> <li>Replace the damaged tubing</li> <li>Replace the Control Main PCB</li> <li>Replace the Control Main PCB</li> </ul>
<ul style="list-style-type: none"> <li>Pressure relief valve activated</li> <li>Intermittent audible alarm</li> <li>Red LED blinking</li> <li>Low pressure</li> </ul>	<p><b>Cycle failure</b></p> <ul style="list-style-type: none"> <li>Unit will cycle then activate the pressure relief valve</li> <li>Unit will not complete the cycle</li> </ul>	<ul style="list-style-type: none"> <li>Verify both wiring harnesses to the solenoid are attached</li> <li>Verify both wiring harnesses have continuity</li> <li>Verify there are no faulty solder joints on the Main PCB</li> <li>Verify there are no component failures on the Main PCB</li> </ul>	<ul style="list-style-type: none"> <li>Reconnect the wiring harnesses</li> <li>Replace wire harnesses main power</li> <li>Replace the Main PCB</li> <li>Replace the Main PCB</li> </ul>
<ul style="list-style-type: none"> <li>Inaccurate oxygen readings</li> </ul>	<p><b>Oxygen percentage indicator (OPI) board failure (Model 605)</b></p> <ul style="list-style-type: none"> <li>Oxygen percentage inaccurate</li> </ul>	<ul style="list-style-type: none"> <li>Verify the OPI board wiring harness is connected</li> <li>Verify the solder joints are not faulty on OPI board</li> <li>Verify there are no component failures on the OPI board</li> <li>Verify the output with a calibrated oxygen analyzer</li> <li>Measure the DC output voltage on Main PCB</li> </ul>	<ul style="list-style-type: none"> <li>Reconnect the wiring harness</li> <li>Replace the OPI board</li> <li>Replace the OPI board</li> <li>Replace the OPI board</li> <li>Replace the Main PCB</li> </ul>

SYMPTOM	CAUSE	VERIFICATION	CORRECTIVE ACTION
<b>Flow Meter failure</b> <ul style="list-style-type: none"> <li>Inaccurate oxygen flow</li> </ul>	<ul style="list-style-type: none"> <li>Flow Meter miscalibrated</li> <li>Flow ball stuck</li> </ul>	<ul style="list-style-type: none"> <li>Verify the Flow Meter can be adjusted properly</li> </ul>	<ul style="list-style-type: none"> <li>Replace the Flow Meter</li> </ul>
<ul style="list-style-type: none"> <li>Loss of power</li> <li>Low pressure alarm</li> </ul>	<b>Compressor compartment thermal switch failure</b> <ul style="list-style-type: none"> <li>Compartment temperature allowed to exceed <math>149 \pm 5^\circ F</math> (<math>65 \pm 5^\circ C</math>)</li> </ul>	<ul style="list-style-type: none"> <li>Verify that air flow around the concentrator is not blocked</li> <li>Verify that all filters are clean</li> <li>Verify that the thermal switch is closing after cooling</li> </ul>	<ul style="list-style-type: none"> <li>Reposition the concentrator to an open area</li> <li>Replace all dirty filters</li> <li>Replace the thermal switch</li> </ul>
<ul style="list-style-type: none"> <li>Loss of power</li> <li>Low pressure alarm</li> </ul>	<b>Compressor thermal switch failure</b> <ul style="list-style-type: none"> <li>Compressor winding temperature allowed to exceed <math>293 \pm 5^\circ F</math> (<math>145 \pm 5^\circ C</math>)</li> </ul>	<ul style="list-style-type: none"> <li>Verify that thermal switch is closing after cooling</li> <li>Verify Compressor is functioning properly</li> </ul>	<ul style="list-style-type: none"> <li>Replace the Compressor</li> </ul>

**SYSTEM PRESSURE TEST TABLE**

SYMPTOM	CAUSE	VERIFICATION	CORRECTIVE ACTION
<ul style="list-style-type: none"> <li>Fluctuating pressure</li> </ul>	<ul style="list-style-type: none"> <li>Difference in Peak pressure is &gt; psig.</li> </ul>	<ul style="list-style-type: none"> <li>Check the oxygen percentage level.</li> </ul>	<p>If the oxygen percentage is not within the specifications listed in the <b>Specifications</b> section:</p> <ul style="list-style-type: none"> <li>Check for leaks</li> <li>Replace Sieve Canister</li> </ul>

*This page intentionally left blank.*

## H600/605 CONCENTRATOR REPAIR & REPLACEMENT

### SECTION OVERVIEW

This chapter illustrates the repair and replacement procedures for the components of the H600/605 Millennium Oxygen Concentrators. Once repair is complete refer to the testing section for proper testing procedures.

#### WARNINGS

- *To prevent electrical shock, disconnect the electrical supply before attempting to make any device repairs to the Millennium Oxygen Concentrators.*
- *Use extreme caution when handling the Compressor/motor assembly Capacitor. The Capacitor can hold a substantial electrical charge until it is properly discharged.*
- *Avoid handling the molecular sieve material. Respironics recommends the return of the Sieve Canister Assembly to Respironics for any service that involves sieve material disposal.*
- *Even with the unit disconnected from the electrical supply, the Capacitor may still hold an electrical charge strong enough to cause serious bodily injury. DO NOT touch the Capacitor terminals simultaneously until the Capacitor has been completely discharged. Discharge the Capacitor by shorting the two posts with an insulated screw driver.*

#### CAUTION

- *Electronic components used in this unit are subject to damage from static electricity. Repairs made to this unit must be performed only in an antistatic, ESD-protected environment.*
- *During all repair and replacement procedures, assure that any connections that are broken during the process (fittings, tubing, and hoses) are reconnected securely.*
- *When using leak detector, be careful that it does not come in contact with any electrical components.*
- *The fuse on the power control board must be replaced with a fuse of the same rating as the original. Failure to do so will result in damage to the unit.*



## **OVERLAY REPLACEMENT**

### **To remove the Overlay**

1. Starting at one corner, carefully peel the Overlay off of the cabinet.
2. Clean any remaining residue from the mounting area.

### **To install the Overlay**

1. Remove the protective backing from the Overlay.
2. Carefully align the Overlay with the mounting area. Set the Overlay in place and, using a circular motion, firmly rub the Overlay until it is securely attached to the cabinet.



**FIGURE A: OVERLAY LOCATIONS**

## CASTER REPLACEMENT

### To remove the Casters

1. Place the unit on a protected work surface and carefully lay the unit on its Rear Cabinet.
2. While holding the unit firmly in place, grasp the Caster to be replaced and pull it firmly out of its receptacle in the molded base.

### NOTE

*It may be necessary to insert a medium flat-blade screwdriver between the Caster and the molded base to “pry” the Caster from its receptacle. Once the Caster has been partially removed, a rubber mallet can be used to completely remove the Caster from its receptacle. If this is necessary, care should be taken to prevent damage to the molded case.*



**FIGURE B: CASTER REMOVAL**

3. If more than one Caster is to be replaced, repeat the procedure for each Caster to be replaced.

### To install the Casters

1. Align the Caster shaft with its receptacle in the molded base.
2. While holding the unit in place, firmly push the Caster into its receptacle until completely seated.

### NOTE

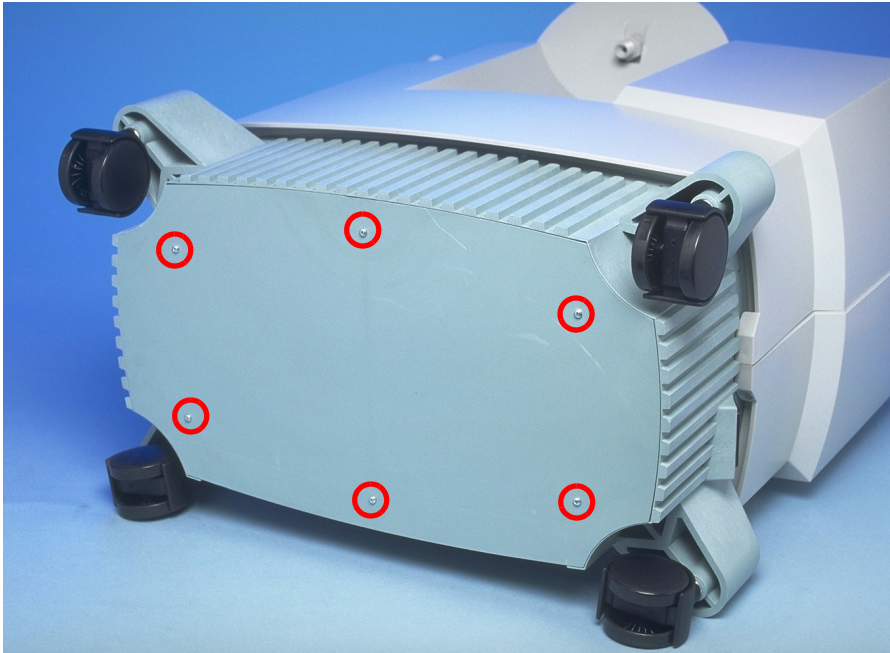
*It may be necessary to use a rubber mallet to gently tap the Caster into the molded base. If this is necessary, care should be taken to prevent damage to the molded case. In some cases, use water to lubricate the post.*

3. If more than one Caster is being replaced, repeat the procedure for each Caster being replaced.
4. Carefully return the unit to the upright position.

## **BASE CABINET PAN REPLACEMENT**

### **To remove the Base Cabinet Pan**

1. Place the unit on a protected work surface and carefully lay the unit over its Rear Cabinet.
2. Remove the six Phillips screws securing the Base Cabinet pan to the Base Cabinet.

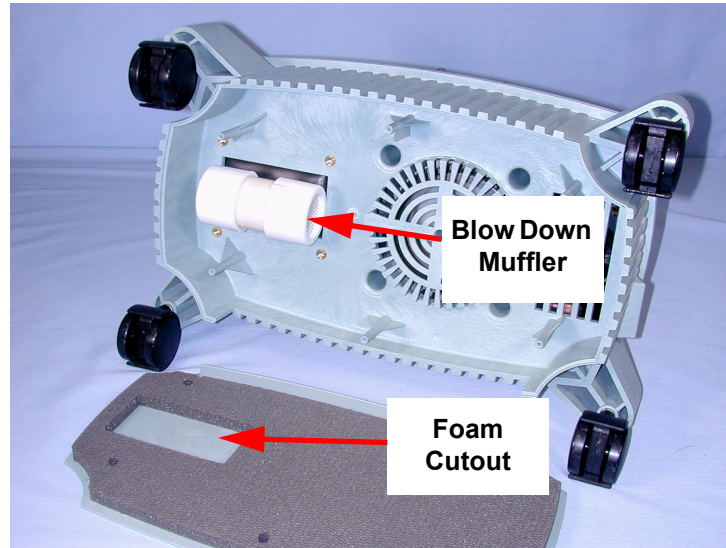


**FIGURE C: SCREW LOCATIONS**

3. Grasp the back edge of the Base Cabinet pan and remove it from the Base Cabinet.

## To install the Base Cabinet Pan

1. Position the Base Cabinet pan so the cut-out in the foam insulation aligns with the Blow Down Muffler.



**FIGURE D: LOCATION OF BLOW DOWN MUFFLER AND FOAM CUTOUT**

2. Align the Base Cabinet pan with the Base Cabinet and set it into place.
3. Insert and gently tighten the six Phillips screws provided to secure the Base Cabinet pan to the Base Cabinet.

## REAR CABINET REPLACEMENT

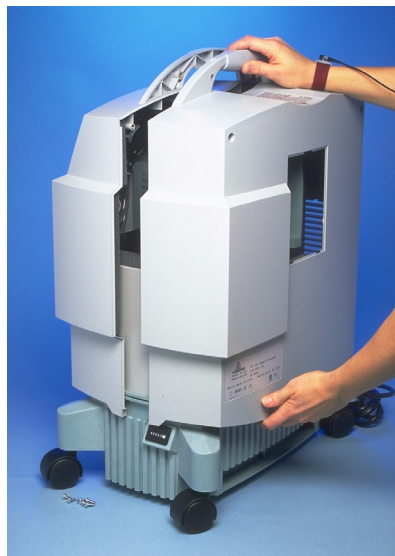
### To remove the Rear Cabinet

1. Using a Phillips screwdriver, remove the six screws that secure the Rear Cabinet to the Front Cabinet.



**FIGURE E: REAR CABINET SCREW LOCATIONS**

2. Grasp the Rear Cabinet firmly then slide it toward the back of the unit until it is clear of the guide slot on the Base Cabinet. Once clear of the guide slot, the Rear Cabinet can be lifted away from the unit.



**FIGURE F: REMOVING THE REAR CABINET**

## To install the Rear Cabinet

### NOTE

*The Base Cabinet has a guide slot to ensure proper alignment of the Rear and Front Cabinets. The Rear and Front Cabinets MUST be properly aligned with the guide slot to ensure correct installation.*

1. Align the ridges on the Rear Cabinet with the guide slot in the Base Cabinet.
2. Once the guide slot and ridges are correctly aligned, hold the Front Cabinet in place while sliding the Rear Cabinet onto the Base Cabinet.



**FIGURE G: PROPER ALIGNMENT OF GUIDE SLOTS AND RIDGES**

3. Using a Phillips screwdriver, install and secure the six mounting screws securing the Rear Cabinet to the Front Cabinet.

## FLOW METER REPLACEMENT

### To remove the Flow Meter

1. Remove the Rear Cabinet. Refer to the Rear Cabinet Replacement Section. Slide the Front Cabinet forward until it is clear from the Base Cabinet.
2. Working from inside the Front Cabinet, cut the cable ties then remove the pressure tubing from both fittings on the Flow Meter by pulling the tubing from each fitting.



**FIGURE H: REMOVAL OF PRESSURE TUBING FROM FLOW METER**

### NOTE

*The pressure tubing connected to the top fitting on the Flow Meter is connected to the Bacteria Filter. The pressure tubing connected to the bottom fitting is connected to the OPI sensor for Model 605, or the 1/2" tubing in the wiring harness for Model 600.*

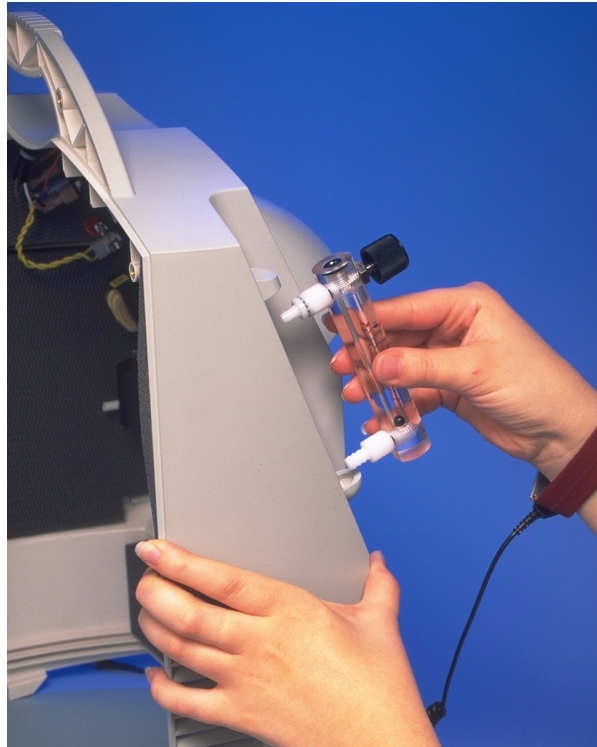


***FIGURE 1: PRESSURE TUBING CONNECTIONS***

3. While holding the Flow Meter in place, remove the two speed nuts from the threaded fittings on the back of the Flow Meter.



4. Remove the Flow Meter from the Front Cabinet assembly by pulling it straight out from the Front Cabinet.



**FIGURE J: REMOVING THE FLOW METER**

**To install the Flow Meter**

1. Align the threaded fittings on the back of the supplied Flow Meter with the holes in the Front Cabinet.

**NOTE**

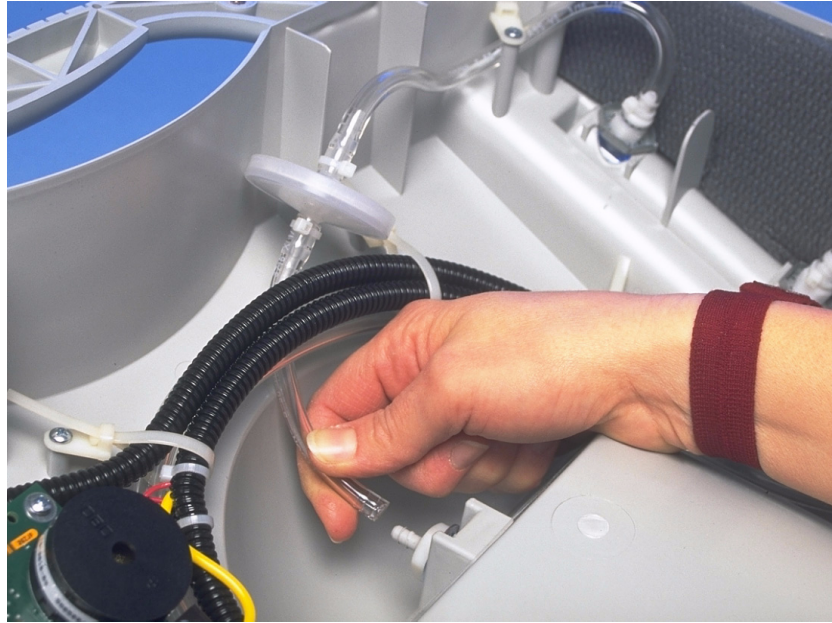
*The Flow Meter must be mounted with the shaft for the Flow Meter knob at the top.*

2. While holding the Flow Meter in place, install the support speed nuts to secure the Flow Meter to the Front Cabinet. Hand tighten the speed nuts.
3. Connect the pressure tubing to the fittings on the Flow Meter then secure the tubing with the cable ties provided.
4. Turn on the unit and check the flow tube connections for leaks.
5. If no leaks are detected, Turn off the unit and reassemble and test unit.

## **DISS OUTLET FITTING REPLACEMENT**

### **To remove the DISS Outlet Fitting**

1. Remove the Rear Cabinet. Refer to the Rear Cabinet Replacement Section.
2. Slide the Front Cabinet forward until it is clear from the Base Cabinet.
3. Cut the cable tie then remove the pressure tubing connected to the DISS outlet fitting by pulling it off the fitting.



***FIGURE K: REMOVING PRESSURE TUBING FROM DISS FITTING***

4. While holding the DISS outlet fitting in place, use an 11/16" wrench to loosen the nylon jam nut securing the DISS outlet fitting.



***FIGURE L: REMOVING THE JAM NUT***

5. Remove the DISS outlet fitting from the Front Cabinet.



**FIGURE M: REMOVING THE DISS FITTING**

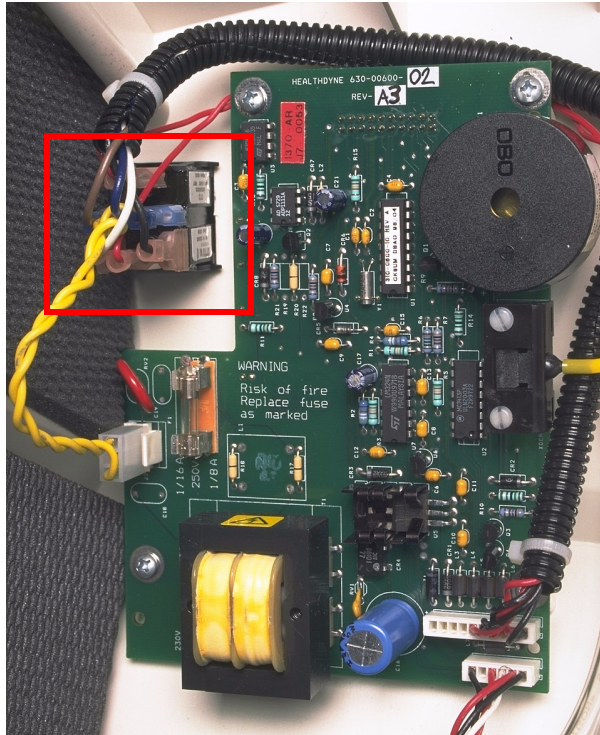
**To install the DISS Outlet Fitting**

1. Align the DISS outlet fitting with the opening in the Front Cabinet. Insert the DISS outlet fitting into the opening.
2. While holding the DISS outlet fitting in place, install the new lock washer and nylon jam nut on the DISS outlet fitting. Use an 11/16" wrench to carefully tighten the nylon jam nut.
3. Connect the pressure tubing to the DISS outlet fitting. Secure the tubing to the fitting with the cable tie provided.

## POWER SWITCH REPLACEMENT

### To remove the Power Switch

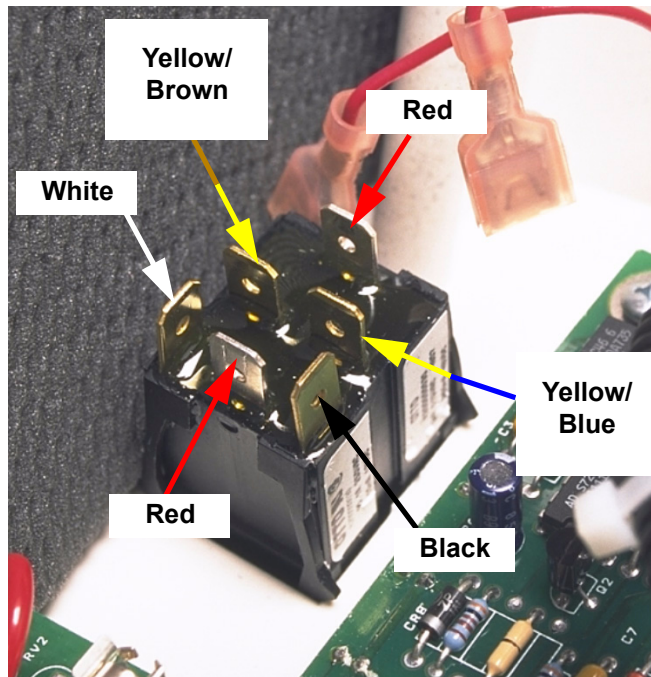
1. Remove the Rear Cabinet. Refer to the Rear Cabinet Replacement Section. Slide the Front Cabinet forward until it is clear from the Base Cabinet.
2. Looking at the back of the Power Switch from inside the Front Cabinet, note the position and colors of the wires connected to the terminals on the Power Switch.



**FIGURE N: VIEW OF POWER SWITCH FROM INSIDE THE FRONT CABINET ASSEMBLY**

### CAUTION

*Except for the two red wires that are interchangeable, the wires must be connected to the Power Switch as shown. Failure to do so will result in damage to the unit.*



**FIGURE O: CORRECT CONNECTION OF THE WIRES TO THE POWER SWITCH**

3. Using needle nose pliers, remove the wires from the Power Switch terminals. Using your fingers or a small flat-blade screwdriver, depress the latches on each corner of the Power Switch.
4. While depressing the latches, push the Power Switch out of the Front Cabinet assembly.



**FIGURE P: REMOVING THE POWER SWITCH FROM THE FRONT CABINET ASSEMBLY**

### To install the Power Switch

1. Orient the Power Switch so that the single terminal is at the top. Align the Power Switch with the opening in the Front Cabinet assembly. Press the Power Switch into the Front Cabinet assembly until all four latches on the Power Switch lock in place.
2. Install the wires onto the terminals of the Power Switch. Ensure that they are installed in their original position.

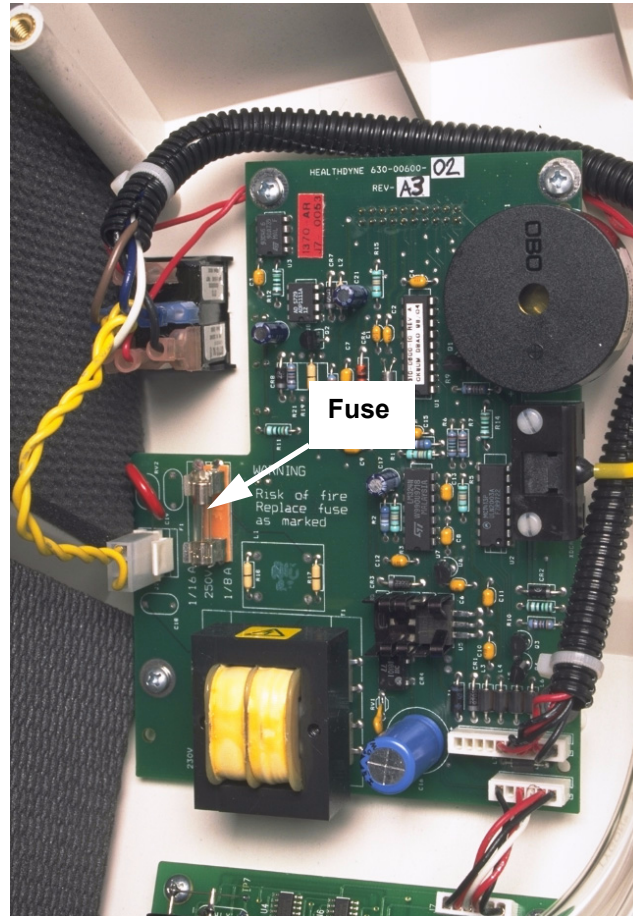
## MAIN PCB FUSE REPLACEMENT

### To remove the Main PCB Fuse

1. Remove the Rear Cabinet. Refer to the Rear Cabinet Replacement Section. Slide the Front Cabinet forward until it is clear from the Base Cabinet.
2. Using a fuse extractor, remove the fuse from its receptacle on the Main PCB.

### To install the Main PCB Fuse

1. Align the fuse with its receptacle on the Main PCB.
2. Carefully press the fuse into its receptacle until completely seated.



**FIGURE Q: FUSE LOCATION**

## MAIN PCB REPLACEMENT

### CAUTION

*Electronic components used in this unit are subject to damage from static electricity. Repairs made to this unit must be performed only in an antistatic, ESD-protected environment.*

#### To remove the Main PCB

1. Remove the Rear Cabinet. Refer to the Rear Cabinet Replacement Section. Slide the Front Cabinet forward until it is clear from the Base Cabinet.
2. While holding the pressure transducer, remove the thin yellow pressure tubing from the pressure transducer by carefully pulling the tubing off the fitting.
3. Remove the main power wiring harness connector from the J1 location on the Main PCB assembly by pulling the connector directly up from the J1 receptacle.
4. **For Model 605 units Only:** Remove the OPI wiring harness connector from the J3 location on the Main PCB assembly by pulling the connector directly up from the J3 receptacle.
5. Depress the locking tab, then remove the Power Switch wiring harness connector from the J2 location on the Main PCB by pulling the connector directly up from the J2 receptacle.
6. Using a Phillips screwdriver, remove the four screws securing the Main PCB assembly to the Front Cabinet. While holding the wiring harness out of the way, remove the Main PCB assembly from the Front Cabinet assembly.

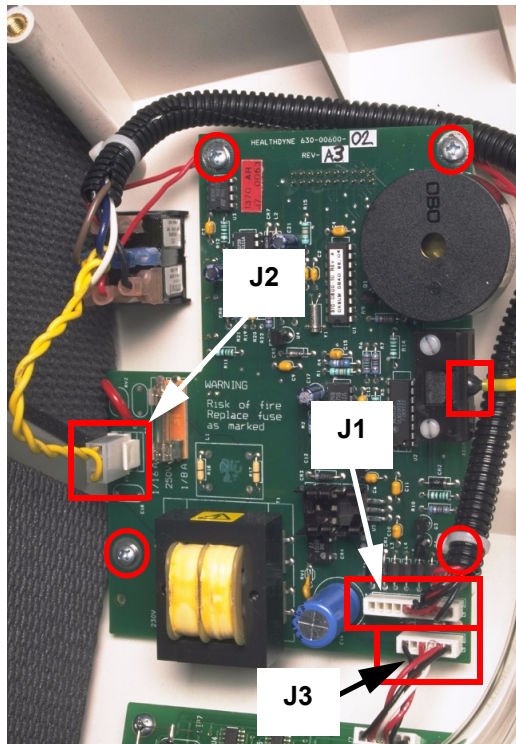
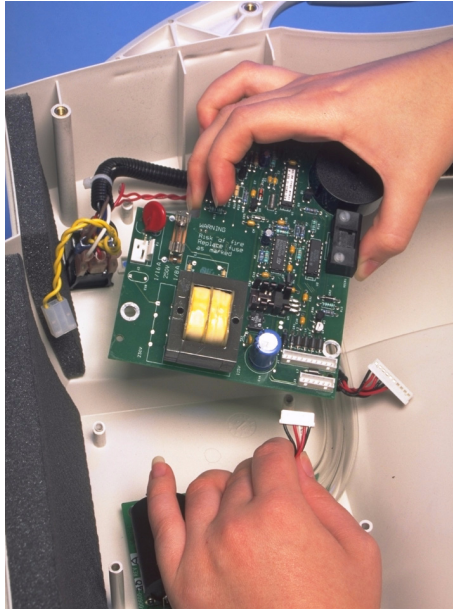


FIGURE R: CONNECTIONS AND MOUNTING SCREW LOCATIONS



**FIGURE S: REMOVING THE MAIN PCB**

### To install the Main PCB

1. While holding the wiring harnesses out of the way, align the holes in the Main PCB assembly with the standoffs on the Front Cabinet assembly.
2. Insert then tighten the four screws provided to secure the Main PCB assembly to the Front Cabinet assembly.
3. Align the connector on the Power Switch wiring harness with the J2 receptacle on the Main PCB assembly. Carefully press the connector onto the receptacle until completely seated.
4. **For Model 605 units Only:** Align the connector on the short OPI wiring harness with the J3 receptacle on the Main PCB assembly. Carefully press the connector onto the receptacle until completely seated.
5. Align the connector on the main power wiring harness with the J1 receptacle on the Main PCB assembly. Carefully press the connector onto the receptacle until completely seated.
6. While holding the pressure transducer, install the thin yellow pressure tubing onto the pressure transducer by firmly and carefully pushing the tubing onto the fitting.



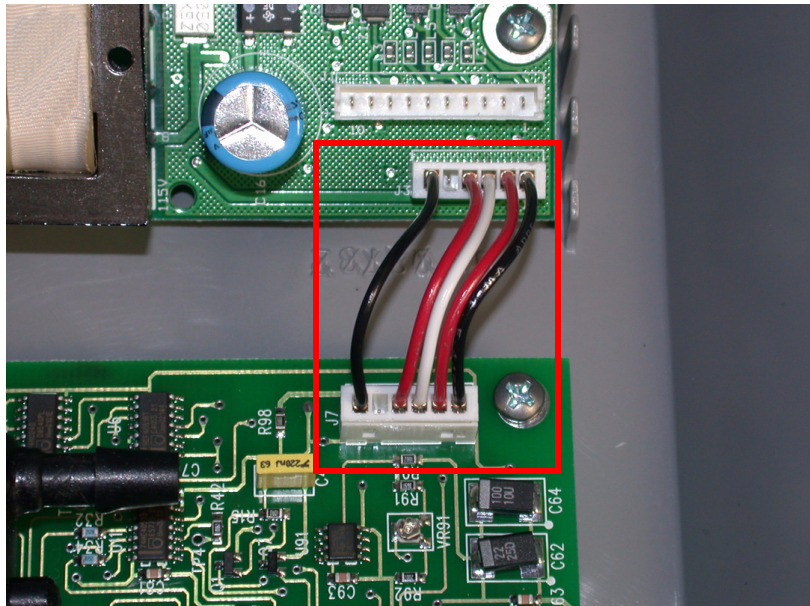
## OPI WIRING HARNESS REPLACEMENT (MODEL H605 ONLY)

### CAUTION

*Electronic components used in this unit are subject to damage from static electricity. Repairs made to this unit must be performed only in an antistatic, ESD-protected environment.*

#### To remove the OPI Wiring Harness

1. Remove the Rear Cabinet. Refer to the Rear Cabinet Replacement Section. Slide the Front Cabinet forward until it is clear from the Base Cabinet.
2. Remove the OPI wiring harness connector from the J3 location on the Main PCB assembly by pulling the connector directly up from the J3 receptacle.
3. Remove the OPI wiring harness connector from the J7 location on the OPI board by pulling the connector directly up from the J7 receptacle.



**FIGURE T: OPI WIRING HARNESS**

#### To install the OPI Wiring Harness

1. Align the connector on the OPI board wiring harness with the J7 receptacle on the OPI board. Carefully press the connector onto the receptacle until completely seated.
2. Align the connector on the OPI wiring harness with the J3 receptacle on the Main PCB assembly. Carefully press the connector onto the receptacle until completely seated.

## OPI BOARD REPLACEMENT (MODEL H605 ONLY)

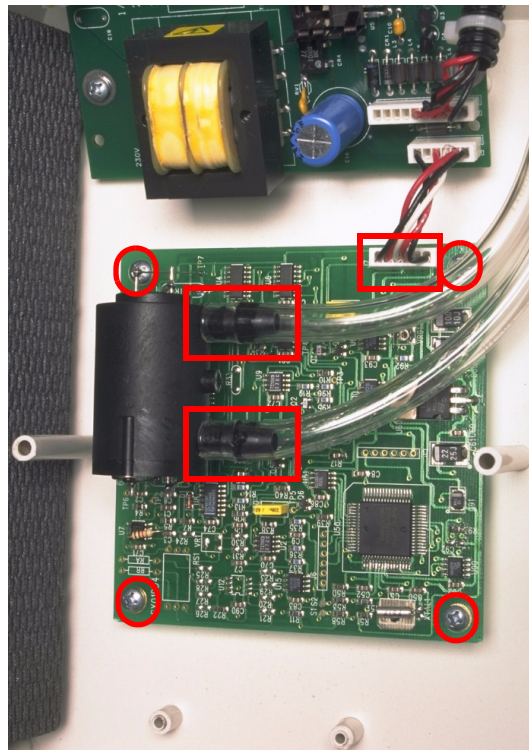
### To remove the OPI Board

1. Remove the Rear Cabinet. Refer to the Rear Cabinet Replacement Section. Slide the Front Cabinet forward until it is clear from the Base Cabinet.
2. Remove the OPI wiring harness connector from the J7 location on the OPI board by pulling the connector directly up from the J7 receptacle.
3. While holding the oxygen sensor, remove the pressure tubing from the sensor by carefully prying the tubing off both oxygen sensor fittings.

### NOTE

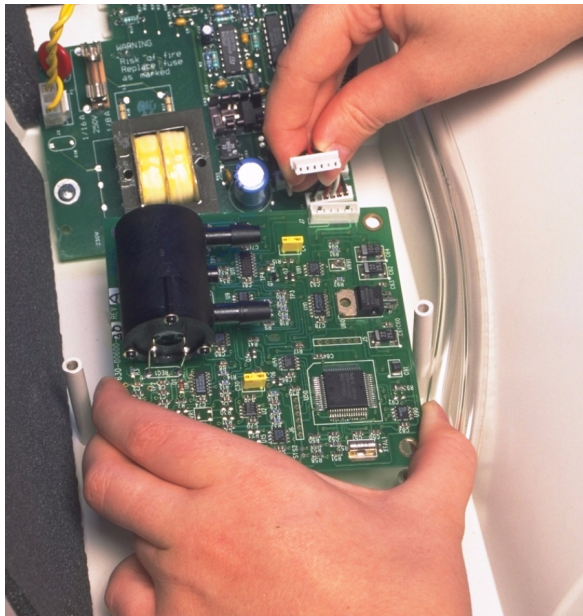
*The pressure tubing from the Flow Meter is connected to the top fitting on the oxygen sensor. The pressure tubing connected to the pressure regulator on the Sieve Canister Assembly is connected to the bottom fitting on the oxygen sensor.*

4. Using a Phillips screwdriver, remove the four screws securing the OPI board to the Front Cabinet.



**FIGURE U: CONNECTIONS AND MOUNTING SCREW LOCATIONS**

5. While holding the wiring harness out of the way, remove the OPI board from the Front Cabinet.



**FIGURE V: REMOVING THE OPI BOARD**

#### **To install the OPI Board**

1. Align the holes in the OPI board with the standoffs on the Front Cabinet.
2. Insert then tighten the four screws provided to secure the OPI board to the Front Cabinet.
3. While holding the oxygen sensor, install the pressure tubing on the oxygen sensor by carefully pushing the tubing onto the oxygen sensor fittings.
4. Align the connector on the OPI wiring harness with the J7 receptacle on the OPI board. Carefully press the connector onto the receptacle until completely seated.

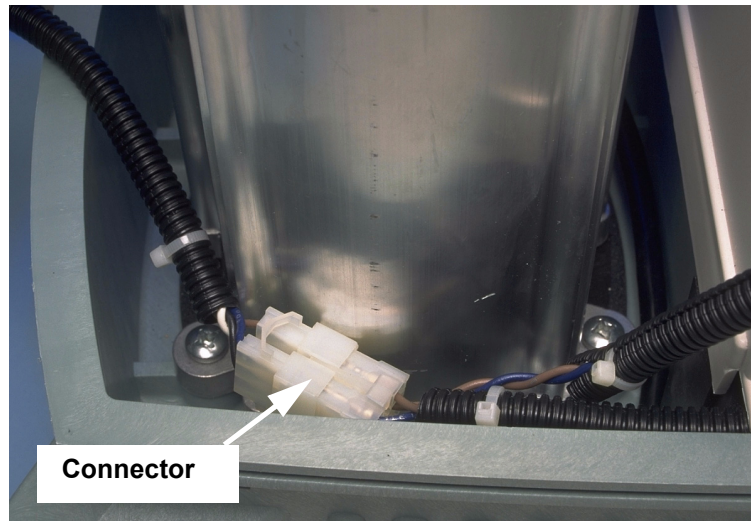
#### **NOTE**

*Once the unit is reassembled, verify that there are no O<sub>2</sub> leaks. Set the Flow Meter to 0 lpm. Ensure the “no flow” alert activates. The alert should activate, if not, check for leaks at newly installed OPI board.*

## POWER SWITCH WIRING HARNESS REPLACEMENT

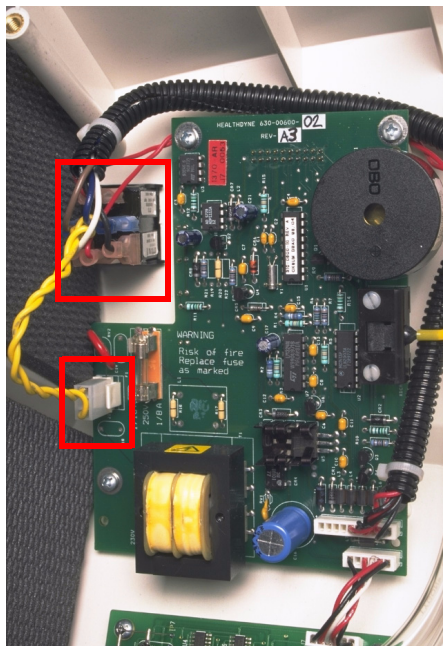
### To remove the Power Switch Wiring Harness

1. Remove the Rear Cabinet. Refer to the Rear Cabinet Replacement Section. Slide the Front Cabinet forward until it is clear from the Base Cabinet.
2. While firmly pushing the locking tabs inward, separate the Power Switch wiring harness from the Main Power Wiring Harness.



**FIGURE W: LOCATION OF THE CONNECTOR**

3. Remove the female connector from the (J2) location on Main PCB.



**FIGURE X: MAIN PCB (J2) AND POWER SWITCH LOCATIONS**

- Looking at the back of the Power Switch from inside the Front Cabinet, note the position and colors of the wires connected to the terminals on the Power Switch.

## CAUTION

*Except for the two red wires that are interchangeable, the wires must be connected to the Power Switch as shown. Failure to do so will result in damage to the unit.*

- Using needle nose pliers, remove the connectors from the Power Switch terminals.

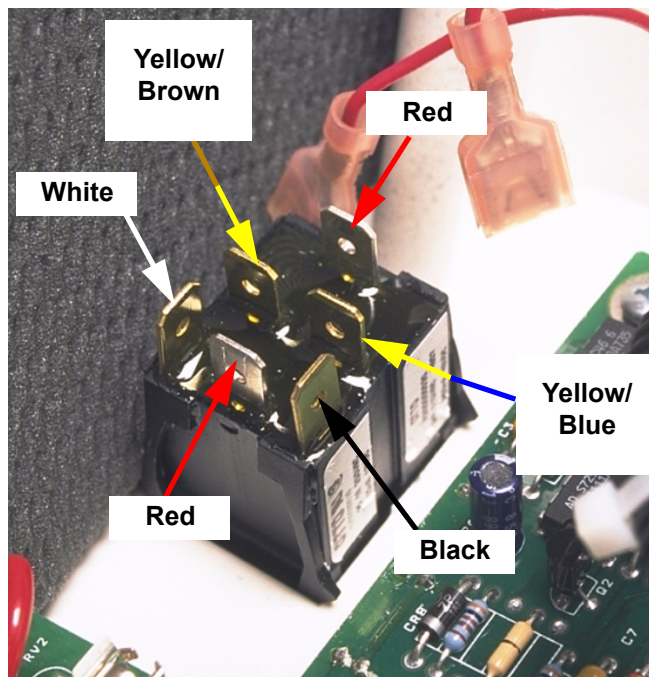
## NOTE

*The two red wires from the O<sub>2</sub>/solenoid/battery wiring harness do not have to be disconnected from the Power Switch.*

- Remove the screws that secure the screw down cables ties to the Front Cabinet.
- Either feed the Power Switch wiring harness through the screw down cable ties or, if new screw down cable ties are available, cut the cable ties and remove the Power Switch wiring harness.

### To install the Power Switch Wiring Harness

- Either feed the Power Switch wiring harness through the original screw down cable ties, or if new screw down cable ties are available, loosely install four cable ties grouping the Power Switch wiring harness, the O<sub>2</sub>/solenoid/battery wiring harness, and the clear and yellow pressure tubing together.
- Install the connectors onto the proper terminals of the Power Switch. Ensure that they are installed in their original position.



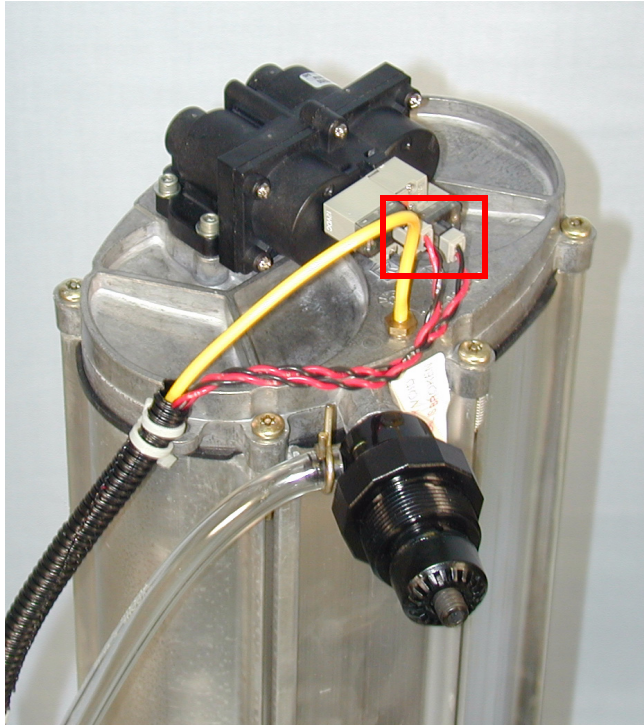
**FIGURE Y: POWER SWITCH TERMINAL LOCATIONS**

3. Install the female connector onto the (J2) location on the Main PCB.
4. Position the screw down cable ties at their mounting posts then secure each using the original screws. Tighten the screw down cable ties.
5. Connect the Power Switch wiring harness to the main power wiring harness.

## O<sub>2</sub>/SOLENOID/BATTERY WIRING HARNESS

### To remove the O<sub>2</sub>/Solenoid/Battery Wiring Harness

1. Remove the Rear Cabinet. Refer to the Rear Cabinet Replacement Section. Slide the Front Cabinet forward until it is clear from the Base Cabinet.
2. Remove the battery connector from the battery.
3. Remove the two connectors from the Valve/Solenoid Assembly.



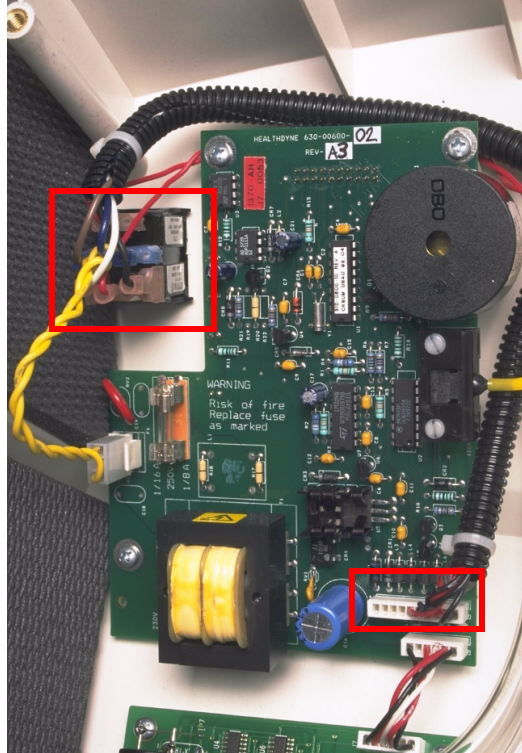
**FIGURE Z: VALVE/SOLENOID CONNECTIONS**

4. Remove the yellow pressure tubing from the top of the Sieve Canister.
5. Remove the pressure tubing from the pressure regulator assembly.
6. Remove the two red wires connected to the Power Switch.

### NOTE

*The two red/black wiring harnesses are interchangeable.*

7. Remove the O<sub>2</sub>/solenoid/battery wiring harness connector from the J1 location on the Main PCB.



**FIGURE AA: POWER SWITCH AND MAIN PCB J1 LOCATION**

8. Remove the screws that secure the screw down cable ties to the Front Cabinet.
9. Either feed the O<sub>2</sub>/solenoid/battery wiring harness through the screw down cable ties or, if new screw down cable ties are available, cut the cable ties and remove the O<sub>2</sub>/solenoid/battery wiring harness.
10. Note the location at which the battery wires exit the large convoluted tubing. Cut the cable ties and remove the O<sub>2</sub>/solenoid/battery wiring harness from the convoluted tubing.



### To install the O<sub>2</sub>/Solenoid/Battery Wiring Harness

1. Install the O<sub>2</sub>/solenoid/battery wiring harness into the large convoluted tubing. Ensure that the battery wires exit the large convoluted tubing at their original location. Secure the convoluted tubing with four cable ties.
2. Either feed the O<sub>2</sub>/solenoid/battery wiring harness through the original screw down cable ties, or if new screw down cable ties are available, loosely install four cable ties grouping the O<sub>2</sub>/solenoid/battery wiring harness, Power Switch wiring harness, along with the clear and yellow pressure tubing together.
3. Install the O<sub>2</sub>/solenoid/battery wiring harness connector onto the J1 location on the Main PCB.
4. Install the two red wires from the O<sub>2</sub>/solenoid/battery wiring harness to the Power Switch.
5. Position the screw down cable ties at their mounting posts then secure each using the original screws. Tighten the screw down cable ties.
6. Install the two connectors from the O<sub>2</sub>/solenoid/battery wiring harness on the Valve/Solenoid Assembly.
7. Connect the yellow pressure tubing to the top of the Sieve Canister.
8. Connect the pressure tubing to the pressure regulator assembly.
9. Install the battery connector on the battery.

## **FRONT CABINET REPLACEMENT**

### **To remove the Front Cabinet**

1. Remove the Rear Cabinet. Refer to the Rear Cabinet Replacement Section. Slide the Front Cabinet forward until it is clear from the Base Cabinet.
2. Remove the Flow Meter. Refer to the Flow Meter Replacement Section.
3. Remove the DISS outlet fitting. Refer to the DISS Outlet Fitting Replacement Section.
4. Remove the Power Switch harness. Refer to the Power Switch Wiring Harness Replacement Section.
5. Remove the O<sub>2</sub>/solenoid/battery wiring harness. Refer to the O<sub>2</sub>/Solenoid/Battery Wiring Harness Section.
6. Remove the Power Switch. Refer to the Power Switch Replacement Section.
7. Remove the OPI Wiring Harness. Refer to the OPI Wiring Harness Replacement (Model H605 Only) Section.
8. Remove the Main PCB. Refer to the Main PCB Replacement Section.
9. Remove the OPI board. Refer to the OPI Board Replacement (Model H605 Only) Section.

### **To install the Front Cabinet**

1. Remove the protective backing from the control Overlay. Carefully aligning the Overlay apply it to the Front Cabinet.
2. Position the Front Cabinet face down on a protected work surface that will not damage the Front Cabinet.
3. Install the OPI Board. Refer to the OPI Board Replacement (Model H605 Only) Section.
4. Install the Main PCB. Refer to the Main PCB Replacement Section.
5. Install the OPI Wiring Harness. Refer to the OPI Wiring Harness Replacement (Model H605 Only) Section.
6. Install the Power Switch. Refer to the Power Switch Replacement Section.
7. Install the O<sub>2</sub>/solenoid/battery wiring harness. Refer to the O<sub>2</sub>/Solenoid/Battery Wiring Harness Section.
8. Install the Power Switch harness. Refer to the Power Switch Wiring Harness Replacement Section.
9. Install the DISS outlet fitting. Refer to the DISS Outlet Fitting Replacement Section.
10. Install the Flow Meter. Refer to the Flow Meter Replacement Section.
11. Slide the Front Cabinet onto the Base Cabinet.

12. Install the Rear Cabinet. Refer to the Rear Cabinet Replacement Section.



**FIGURE AB: REAR CABINET SCREW LOCATIONS**

## COOLING FAN REPLACEMENT

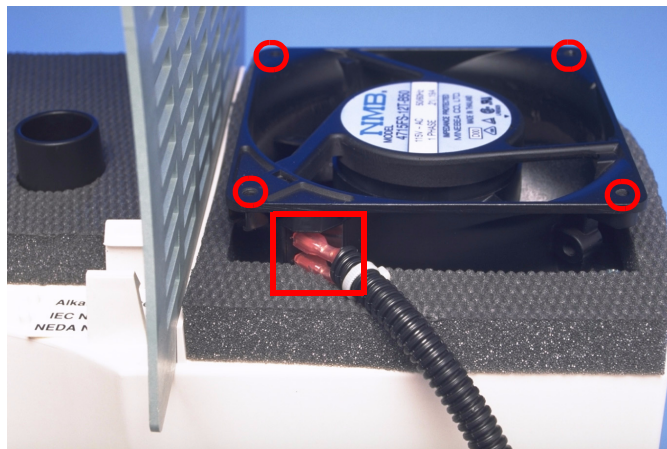
### To remove the Cooling Fan

1. Remove the Rear Cabinet. Refer to the Rear Cabinet Replacement Section.
2. Slide the Front Cabinet forward until it is clear from the Base Cabinet.
3. Remove the two wires from the terminals located on the side of the cooling fan.

### NOTE

*The two wires are interchangeable.*

4. Using a small, thin shaft Phillips screwdriver, remove the four screws securing the cooling fan to the Compressor Cover.



**FIGURE AC: WIRE AND SCREW LOCATIONS**

5. While holding the Compressor Cover in place, lift the fan up and away from the Compressor Cover.



**FIGURE AD: REMOVING FAN FROM COMPRESSOR HOUSING**

**To install the Cooling Fan**

1. Align the cooling fan with the holes in the Compressor Cover.

**NOTE**

*The fan must be installed so the terminals are oriented towards the front and center of the unit.*

2. Insert then tighten the four screws to secure the fan to the Compressor Cover.
3. Connect the fan wires to the terminals on the side of the cooling fan.

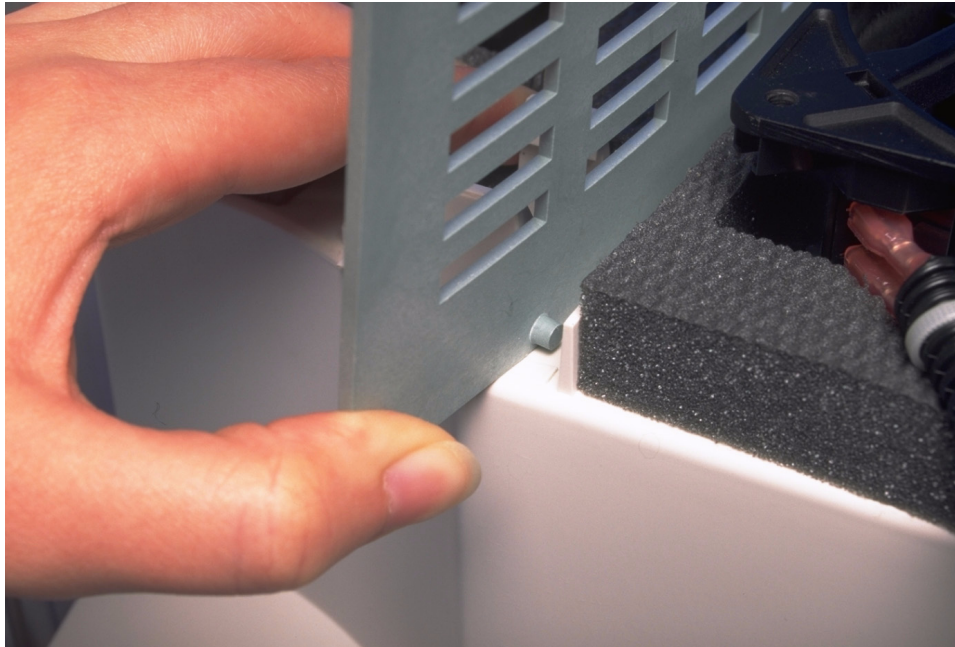
**NOTE**

*Ensure that the convoluted tubing covering the fan wires is still properly seated in the wire holder built into the front of the Compressor.*

## **PERFORATED CANOPY REPLACEMENT**

### **To remove the Perforated Canopy**

1. Remove the Rear Cabinet. Refer to the Rear Cabinet Replacement Section.
2. Slide the Front Cabinet forward until it is clear from the Base Cabinet.
3. Remove the 9-volt alarm battery from its holder.
4. Press inward on the bottom of each side of the Perforated Canopy until the locating posts are clear of the holes in the Compressor Cover.



***FIGURE AE: RELEASING CANOPY FROM COMPRESSOR COVER***

5. Lift the Perforated Canopy up and away from the Compressor Cover.

### **To install the Perforated Canopy**

1. While exerting slight inwards pressure on the sides of the Perforated Canopy, align the locating posts with the holes in the Compressor Cover.
2. Release the pressure, then ensure that the locating posts have locked in place in the Compressor Cover.
3. Install the 9-volt battery in its holder.

## COMPRESSOR COVER REPLACEMENT

### To remove the Compressor Cover

1. Remove the Rear Cabinet. Refer to the Rear Cabinet Replacement Section.
2. Slide the Front Cabinet forward until it is clear from the Base Cabinet.
3. Remove the cooling fan. Refer to the Cooling Fan Replacement Section.
4. Remove the Perforated Canopy. Refer to the Perforated Canopy Replacement Section.
5. Remove the convoluted tubing containing the fan wires from the wire holder built into the front of the Compressor Cover.
6. Remove the 9-volt battery.
7. Lift the Compressor Cover housing straight up and then away from the Base Cabinet.



**FIGURE AF: REMOVING THE COMPRESSOR COVER (PICTURE SHOWN WITH FAN INSTALLED)**

### To install the Compressor Cover

1. Position the Compressor Cover so the built-in wire holder is facing the front of the unit.
2. Align the round hole in the top of the Compressor Cover housing with the inlet port of the Compressor assembly.
3. Set the Compressor Cover into place on the Base Cabinet. Ensure that the bottom of the Compressor Cover housing is correctly seated on the Base Cabinet.
4. Insert the convoluted tubing containing the fan wires into the built-in wire holder on the front of the Compressor Cover.

## MAIN POWER WIRING HARNESS REPLACEMENT

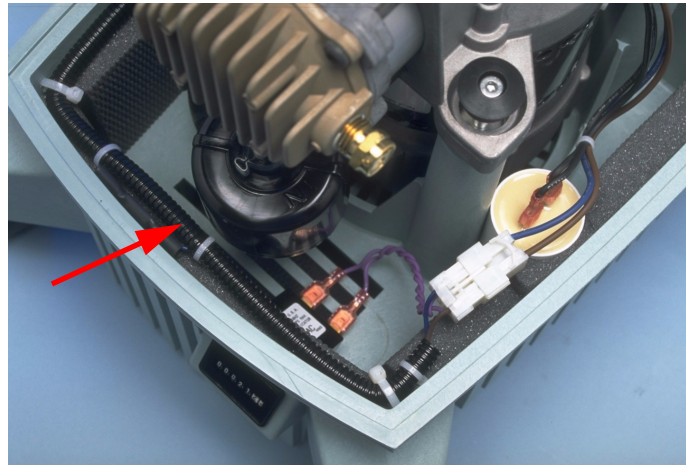
### WARNING

*Make sure the AC power is disconnected.*

### NOTE

*The main power wiring harness has been revised to use a 149 °F(65 °C) thermal switch. The new revision wiring harness uses a BLUE shrink tubing over the revised thermal switch. If the wiring harness in the device being serviced has BLACK shrink tubing over the thermal switch it MUST BE replaced. There is no charge if the wiring harness needs to be changed. Contact Respiration Customer Service to order a replacement wire harness*

### To remove the Main Power Wiring Harness



**FIGURE AG: LOCATION OF THE MAIN POWER WIRING HARNESS**

1. Remove the Rear Cabinet. Refer to the Rear Cabinet Replacement Section.
2. Slide the Front Cabinet forward until it is clear from the Base Cabinet.
3. Remove the Perforated Canopy. Refer to the Perforated Canopy Replacement Section.
4. Remove the Compressor Cover. Refer to the Compressor Cover Replacement Section.



5. Disconnect the female connector on the main power wiring harness from the male connector on the Power Switch harness.



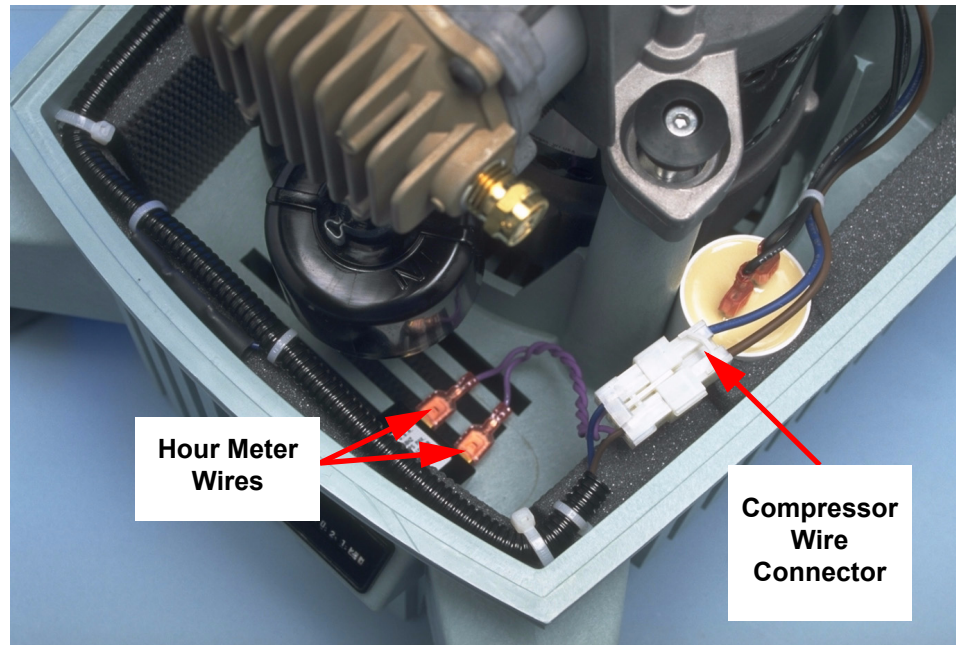
**FIGURE AH: MAIN POWER WIRING HARNESS CONNECTED TO THE POWER SWITCH WIRING HARNESS**

6. Note the position of the Power Cord wires in the main power harness female connector. Using an amp terminal retractor, remove the Power Cord wire from the connector.
7. Note the routing of the main power wiring harness and the location of the cable ties securing the harness to the Base Cabinet. Cut the cable ties.
8. Remove the two connectors from the Hour Meter.

## NOTE

*The wires connected to the Hour Meter are interchangeable.*

9. Disconnect the female connector of the main power wiring harness from the male connector on the Compressor wires.



**FIGURE A1: LOCATION OF THE HOUR METER AND COMPRESSOR WIRE CONNECTOR**

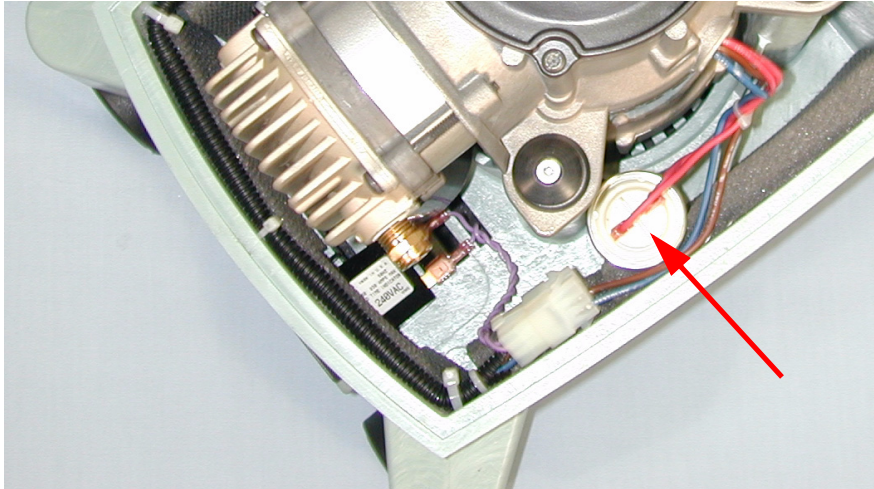
#### **To install the Main Power Wiring Harness**

1. Install the female connector of the main power wiring harness onto the male connector on the Compressor wires.
2. Install the two Hour Meter wires onto the Hour Meter.
3. Route the main power wiring harness along the inside of the Base Cabinet. Secure the main power wiring harness to the Base Cabinet using three cable ties.
4. Install the Power Cord wire connectors in their original position in the main power harness female connector.
5. Install the female connector on the main power wiring harness onto the male connector on the Power Switch wiring harness.

## MOTOR START/RUN CAPACITOR

### To remove the Motor Start/Run Capacitor

1. Remove the Rear Cabinet. Refer to the Rear Cabinet Replacement Section.
2. Slide the Front Cabinet forward until it is clear from the Base Cabinet.
3. Remove the Compressor Cover. Refer to the Compressor Cover Replacement Section.



**FIGURE AJ: CAPACITOR LOCATION**

4. Using insulated needle-nose pliers, carefully remove the female connectors on the Capacitor wires from the two Capacitor terminals.

### CAUTION

*Short the terminals of the Capacitor to discharge.*

5. After the Capacitor is discharged, lift the Capacitor up and out of the molded base.

### To install the Motor Start/Run Capacitor

1. Slide the Capacitor into position between the foam insulation and the Compressor assembly standoff.
2. Connect the Capacitor wires to the terminals on the Capacitor.
3. Make sure the Capacitor terminals are parallel to the rear wall in the Base Cabinet.

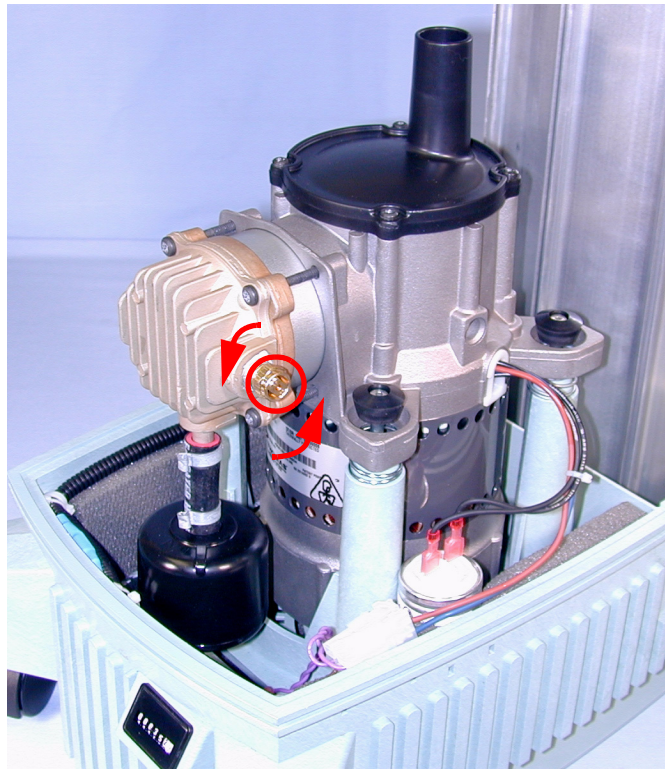
## PRESSURE RELIEF VALVE REPLACEMENT

### NOTE

*If it has been determined that the pressure relief valve must be replaced, the unit should be operated for a minimum of ten minutes to ensure that the Compressor head is warm. This will soften the sealant used on the threads of the pressure relief valve and assist in its removal.*

#### To remove the Pressure Relief Valve

1. Remove the Rear Cabinet. Refer to the Rear Cabinet Replacement Section.
2. Slide the Front Cabinet forward until it is clear from the Base Cabinet.
3. Remove the Compressor Cover. Refer to the Compressor Cover Replacement Section.
4. Run the unit for a minimum of ten minutes to ensure that the Compressor head is warm.
5. Using a 9/16" box end wrench or deep well socket, turn the pressure relief valve counter-clockwise to remove it from the Compressor head.



**FIGURE AK: REMOVING THE PRESSURE RELIEF VALVE**

#### To install the Pressure Relief Valve

1. Apply an appropriate sealer to the threads of the pressure relief valve.
2. Using a 9/16" box end wrench or deep well socket, install the pressure relief valve into the Compressor head. Do not over tighten the pressure relief valve.

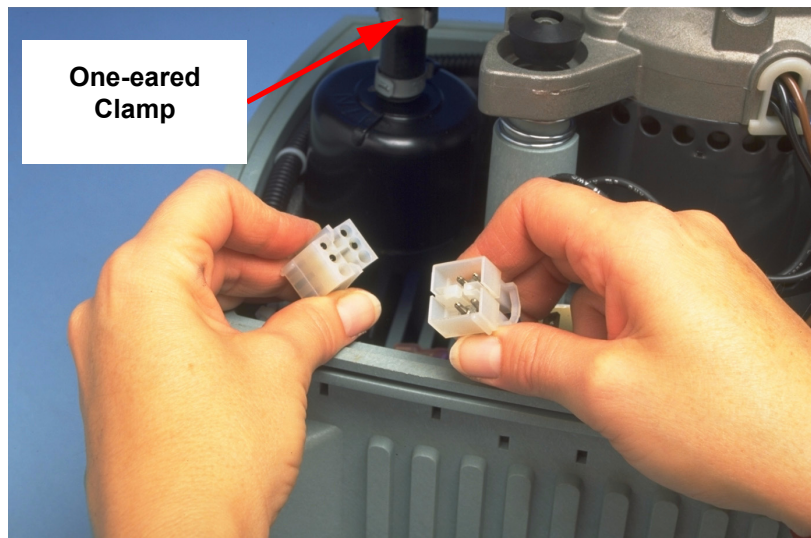
## COMPRESSOR ASSEMBLY REPLACEMENT

### WARNING

*Ensure that the unit is disconnected from the AC power source before beginning this procedure.*

#### To remove the Compressor Assembly

1. Remove the Rear Cabinet. Refer to the Rear Cabinet Replacement Section.
2. Slide the Front Cabinet forward until it is clear from the Base Cabinet.
3. Remove the Compressor Cover. Refer to the Compressor Cover Replacement Section.
4. Disconnect the Compressor assembly harness from the main power cabinet wiring harness by depressing the locking tabs and separating the connectors.



**FIGURE AL: DISCONNECTING THE COMPRESSOR ASSEMBLY WIRING HARNESS AND LOCATION OF THE ONE-EARED CLAMP**

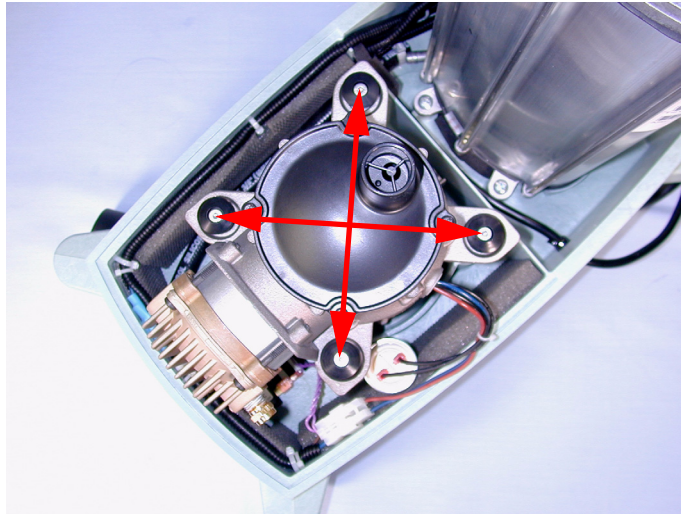
5. Disconnect the wires from the Capacitor terminals.

### NOTE

*The wires connected to the Capacitor are interchangeable.*

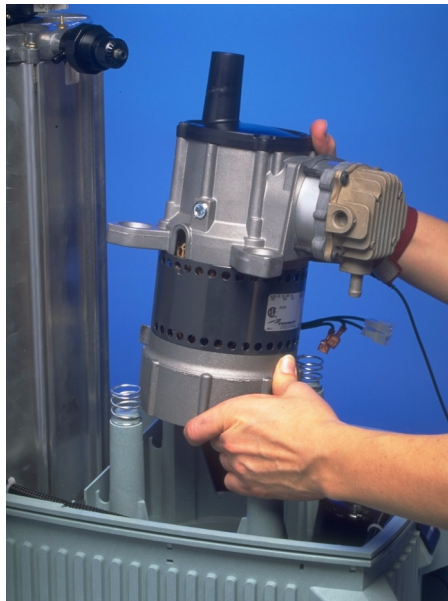
6. Using a crimping clamp tool or diagonals, cut the one-eared clamp securing the pressure tubing to the outlet port of the Compressor assembly. Remove the pressure tubing from the Compressor assembly outlet port.

- Using a 1/8" hex key wrench or socket, remove the four shoulder screws and rubber bumpers securing the Compressor assembly to the standoffs.



**FIGURE AM: LOCATION OF THE SHOULDER SCREWS AND RUBBER BUMPERS**

- Lift the Compressor assembly up from the standoffs and helical springs.



**FIGURE AN: REMOVING THE COMPRESSOR ASSEMBLY**

## NOTE

*If the optional Compressor mount kit is being used, remove the four helical springs from the Compressor assembly standoffs.*

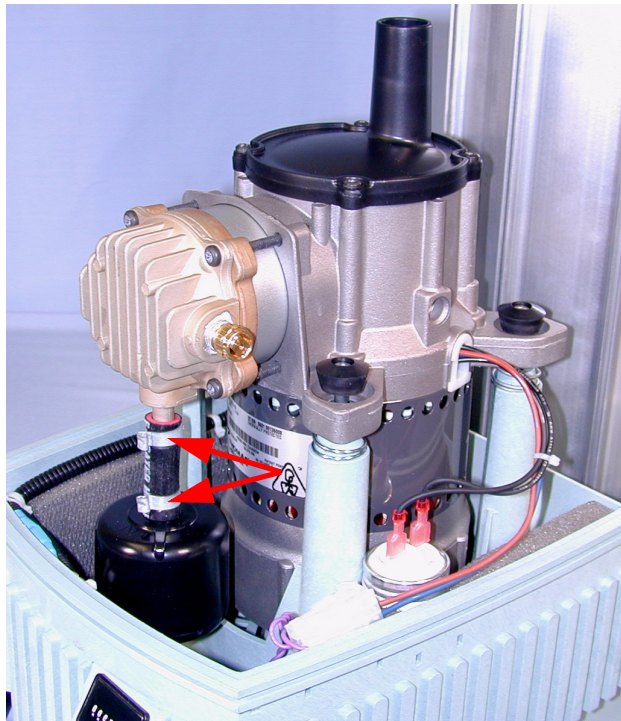
### To install the Compressor Assembly

1. If the optional Compressor mount kit is being used, install the new helical springs on the top of each Compressor assembly standoff.
2. Align the Compressor/motor assembly with the standoffs and helical springs. Set the Compressor assembly in place.
3. If the optional Compressor mount kit is being used, install the new rubber bumpers on each shoulder screw provided. If the optional Compressor mount kit is not being used, ensure that the rubber bumpers are properly seated on the original shoulder screws.
4. Using a 1/8" hex key wrench or socket, install and tighten the four screws and rubber bumpers that secure the Compressor assembly to the standoffs.
5. Slide the supplied one-eared clamp onto the pressure tubing. Align the tubing with the Compressor assembly outlet port. Slide the tubing onto the ports.
6. Slide the one-eared clamp into position on the pressure tubing. Using a crimping clamp tool or diagonals, firmly "pinch" the one-eared clamp to secure the pressure tubing.
7. Confirm that the In-line Muffler is not touching the side wall of the Base Cabinet or main power wiring harness.
8. Install the Capacitor wire connectors onto the terminals of the Capacitor.
9. Align the female connector on the Compressor assembly wiring harness with the connector on the main power wiring harness. Press the connectors together until completely seated and locked together.

## IN-LINE MUFFLER REPLACEMENT

### To remove the In-line Muffler

1. Remove the Rear Cabinet. Refer to the Rear Cabinet Replacement Section.
2. Slide the Front Cabinet forward until it is clear from the Base Cabinet.
3. Remove the Compressor Cover. Refer to the Compressor Cover Replacement Section.
4. Using a crimping clamp tool or diagonals, cut the two one-eared clamps between the Compressor head and In-line Muffler.
5. Straighten the pressure hose to gain access to the bottom on the In-line Muffler. Cut the one-eared clamp then remove the pressure hose.



**FIGURE A0: LOCATION OF THE ONE-EARED CLAMPS**

6. Remove the In-line Muffler.



## To install the In-line Muffler

1. Slide a new one-eared clamp onto the existing 12" pressure hose. Attach the pressure hose to the bottom In-line Muffler.



**FIGURE AP: CORRECT ORIENTATION OF THE IN-LINE MUFFLER**

2. Using a crimping tool or diagonals, firmly "pinch" the one-eared clamp to securely fasten the pressure tubing to the outlet port of the In-line Muffler.
3. Attach the 1 3/4" pressure hose to the inlet port of the In-line Muffler. Slide a new one-eared clamp onto the supplied 2" pressure tubing.
4. Using a crimping tool or diagonals, firmly "pinch" the one-eared clamp to securely fasten the pressure tubing to the inlet port of the In-line Muffler.
5. Slide a one-eared clamp over the 1 3/4" pressure hose.
6. Align then seat the short pressure tubing on the Compressor assembly's outlet port.
7. Using a crimping tool or diagonals, firmly "pinch" the one-eared clamp to secure the connections at the Compressor assembly.

## HRUR METER REPLACEMENT

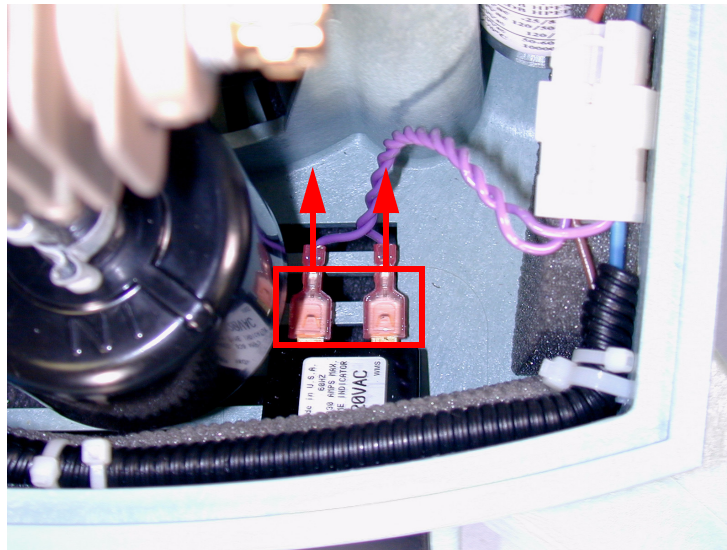
### To remove the Hour Meter

1. Remove the Rear Cabinet. Refer to the Rear Cabinet Replacement Section.
2. Slide the Front Cabinet forward until it is clear from the Base Cabinet.
3. Remove the Compressor Cover. Refer to the Compressor Cover Replacement Section.
4. Using your fingers or needle-nose pliers, remove the wires from the terminals on the back of the Hour Meter.

### NOTE

*The Hour Meter wires are interchangeable.*

5. Spread the tabs on the locking frame out from the Hour Meter.



**FIGURE AQ: REMOVING THE HOUR METER WIRES**

6. While holding the tabs spread away from the Hour Meter, push it through the openings in the Base Cabinet.



**FIGURE AR: REMOVING THE HOUR METER**

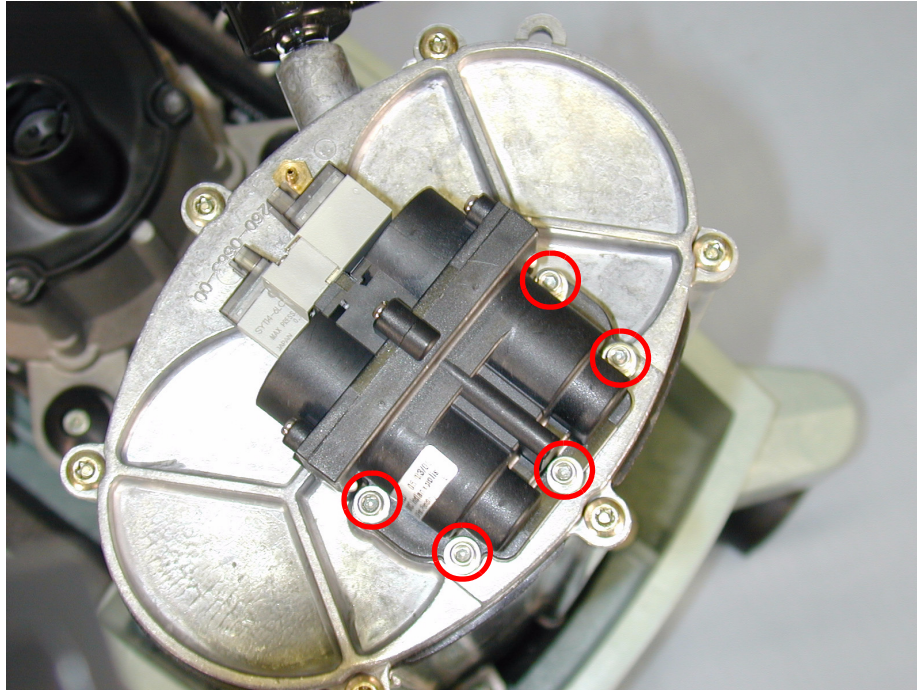
**To install the Hour Meter**

1. Align then insert the Hour Meter into its receptacle in the Base Cabinet.
2. While holding the Hour Meter in place, install the locking frame over the Hour Meter from inside of the Base Cabinet. Press it onto the Hour Meter until it “snaps” in place.
3. Install the Hour Meter wires on the terminals on the back of the Hour Meter.

## VALVE/SOLENOID REPLACEMENT

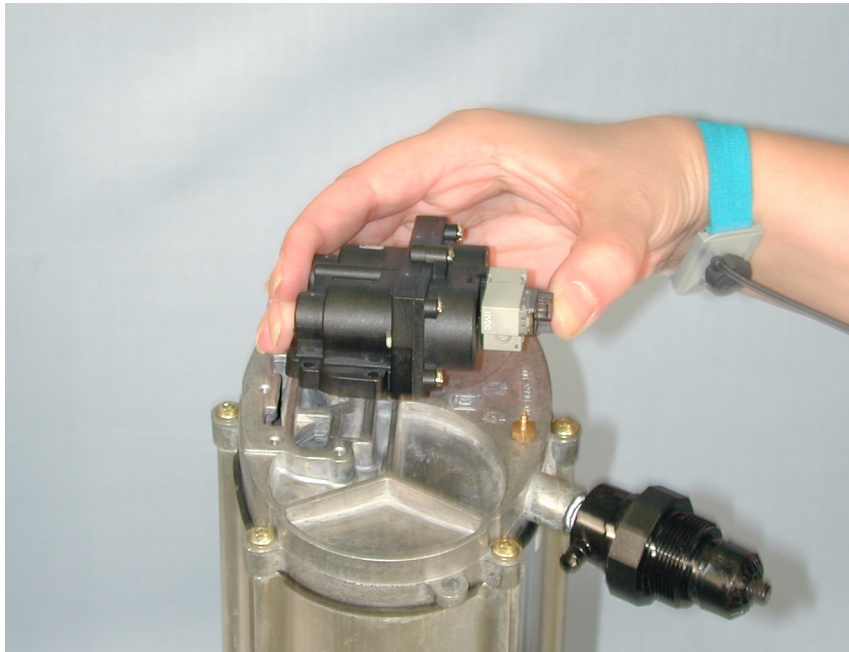
### To remove the Valve/Solenoid

1. Remove the Rear Cabinet. Refer to the Rear Cabinet Replacement Section.
2. Slide the Front Cabinet forward until it is clear from the Base Cabinet.
3. Remove the two wire connectors from the Valve/Solenoid Assembly.
4. Using a 7/64" hex key wrench or socket, remove the five screws and flat washers securing the Valve/Solenoid to the top of the Sieve Canister Assembly.



**FIGURE AS: LOCATION OF THE SCREWS SECURING THE VALVE/SOLENOID ASSEMBLY**

5. Lift the Valve/Solenoid Assembly up and away from the Sieve Canister Assembly.



**FIGURE AT: REMOVING THE VALVE/SOLENOID ASSEMBLY**

**To install the Valve/Solenoid Assembly**

1. Align the Valve/Solenoid Assembly with the holes in the top of the Sieve Canister Assembly.
2. Using the five screws and flat washers provided, secure the Valve/Solenoid Assembly to the Sieve Canister Assembly. The screws should be torqued sufficiently in order to prevent leaks, but care should be taken not to crush the shoulder of the valve.
3. Reconnect the two wire connectors to the Valve/Solenoid Assembly.
4. Connect the unit to a power source and turn on the device. Apply snoop leak detector to the area where the Valve/Solenoid Assembly mounts to the Sieve Canister Assembly and check for leaks.

## PRESSURE REGULATOR REPLACEMENT

### To remove the Pressure Regulator

1. Remove the Rear Cabinet. Refer to the Rear Cabinet Replacement Section.
2. Slide the Front Cabinet forward until it is clear from the Base Cabinet.
3. Remove the pressure tubing from the outlet port on the pressure regulator.
4. Note the orientation of the pressure regulator outlet port. The new pressure regulator must be installed with the outlet port in the same position.
5. Using a pair of channel locks, remove the pressure regulator from the Sieve Canister Assembly.



**FIGURE AU: REMOVING THE PRESSURE REGULATOR**

### To install the Pressure Regulator

1. Apply a layer of Teflon thread tape to the threads of the pressure regulator.

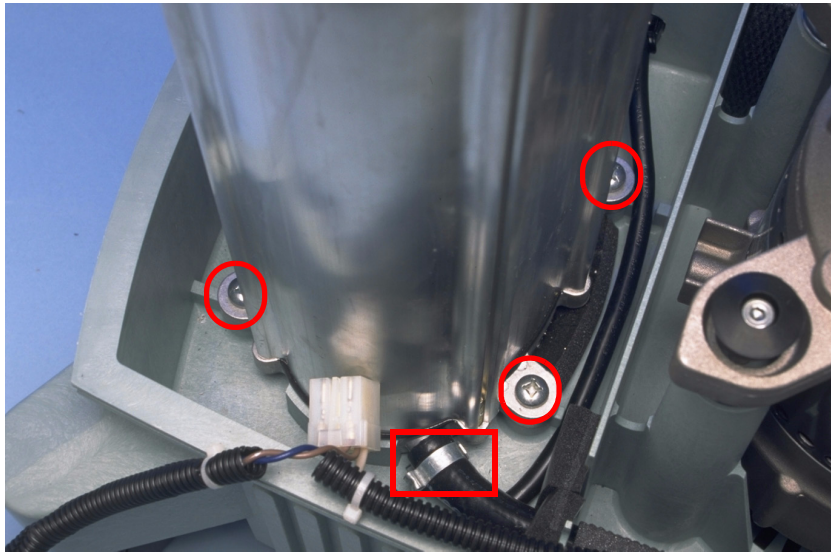
#### CAUTION

*The tape should be installed in a counter clockwise direction, with the Pressure Regulator threads facing you.*

2. Align the pressure regulator with the pressure regulator port in the Sieve Canister Assembly. Screw the pressure regulator into the Sieve Canister Assembly until strong resistance is felt and the pressure regulator outlet port is oriented in the correct position.
3. Install the pressure tubing on the pressure regulator outlet port.
4. Connect the unit to a power source and turn on the unit. Apply snoop leak detector to the area where the pressure regulator mounts to the Sieve Canister Assembly and where the O<sub>2</sub> tubing connects to the outlet barb to check for leaks.

## SIEVE CANISTER ASSEMBLY REPLACEMENT

1. Remove the Rear Cabinet. Refer to the Rear Cabinet Replacement Section.
2. Slide the Front Cabinet forward until it is clear from the Base Cabinet.
3. Remove the Compressor Cover. Refer to the Compressor Cover Replacement Section.
4. Remove the Valve/Solenoid Assembly. Refer to the Valve/Solenoid Replacement Section.
5. Remove the pressure regulator. Refer to the Pressure Regulator Replacement Section.
6. Using a phillips screwdriver, remove the four screws securing the Sieve Canister Assembly to the Base Cabinet.
7. Using a crimping clamp tool or diagonals, cut the one-eared clamp securing the 12" pressure tubing to the inlet port of the Sieve Canister.
8. Remove the 12" pressure tubing from the inlet port of the Sieve Canister.



**FIGURE AV: LOCATION OF THE ONE-EARED CLAMP AND MOUNTING SCREWS(3 OF 4 SHOWN IN PICTURE)**

- Lift the Sieve Canister Assembly up and out of the Base Cabinet.



**FIGURE AW: REMOVING THE SIEVE CANISTER**

- Remove the Blow Down Muffler from the Sieve Canister Assembly. Refer to the Blow Down Muffler Replacement Section.
- Remove the brass fitting from the top of the Sieve Canister Assembly.

#### **To install the Sieve Canister Assembly**

- Install the supplied Canister Gasket on the bottom of the Sieve Canister Assembly.
- Install the brass fitting in the top of the Sieve Canister Assembly.
- Install the Blow Down Muffler onto the Sieve Canister Assembly. Refer to the Blow Down Muffler Replacement Section.
- Set the Sieve Canister Assembly in place in the Base Cabinet.

#### **NOTE**

*Ensure that the AC Power Cord is clear of the Sieve Canister Assembly.*

- Slide the one-eared clamp provided onto the 12" pressure tubing.
- Install the 12" pressure tubing provided on the inlet port of the Sieve Canister.
- Using a crimping clamp tool or diagonals, "pinch" the one-eared clamp securing the pressure tubing to the inlet port of the Sieve Canister Assembly.
- Using a phillips screwdriver, insert then tighten the four screws that secure the Sieve Canister Assembly to the molded base.
- Install the Valve/Solenoid on the top of the Sieve Canister.
- Install the wire connectors on the terminals of the valve/solenoid.
- Connect the yellow pressure tubing to the brass fitting on the top of the Sieve Canister.
- Connect the clear pressure tubing to the port on the pressure regulator.



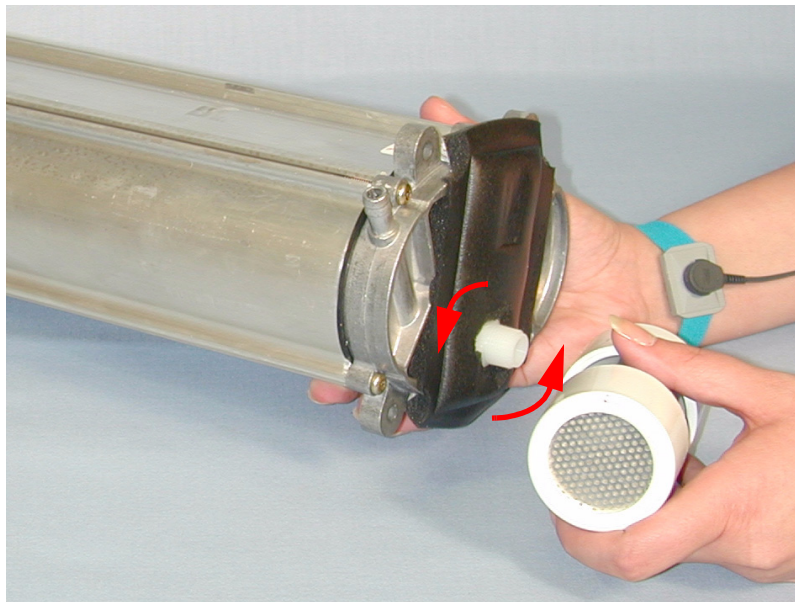
## BLOW DOWN MUFFLER REPLACEMENT

### NOTE

*If care is taken during the following procedures, the Valve/Solenoid Assembly and the pressure regulator do not have to be removed. However, if these components are damaged during the procedure, they must be replaced.*

#### To remove the Blow Down Muffler

1. Remove the Rear Cabinet. Refer to the Rear Cabinet Replacement Section.
2. Slide the Front Cabinet forward until it is clear from the Base Cabinet.
3. Remove the Compressor Cover. Refer to the Compressor Cover Replacement Section.
4. Remove the Valve/Solenoid Assembly. Refer to the Valve/Solenoid Replacement Section.
5. Remove the pressure regulator. Refer to the Pressure Regulator Replacement Section.
6. Note the orientation of the Blow Down Muffler in relation to the Sieve Canister Assembly.
7. Using channel locks, turn the Blow Down Muffler counter-clockwise until it is free of the sieve canister assembly.



**FIGURE AX: REMOVING THE BLOW DOWN MUFFLER**

**To install the Blow Down Muffler**

1. Align the Blow Down Muffler with the Sieve Canister Assembly's threaded fitting. Screw the Blow Down Muffler onto the fitting until it comes in contact with the Sieve Canister foam and the Blow Down Muffler is positioned in its original orientation.
2. Set the Sieve Canister Assembly in place in the Base Cabinet.

**NOTE**

*Ensure that the AC Power Cord is clear of the Sieve Canister Assembly.*

3. Slide the one-eared clamp provided onto the 12" pressure tubing.
4. Install the 12" pressure tubing provided on the inlet port of the Sieve Canister.
5. Using a crimping clamp tool or diagonals, "pinch" the one-eared clamp securing the pressure tubing to the inlet port of the Sieve Canister Assembly.
6. Using the 5/16" Nut Driver, insert then tighten the four screws that secure the Sieve Canister Assembly to the molded base.
7. Install the Valve/Solenoid on the top of the Sieve Canister.
8. Install the wire connectors on the terminals of the valve/solenoid.
9. Connect the yellow pressure tubing to the brass fitting on the top of the Sieve Canister.
10. Connect the clear pressure tubing to the port on the pressure regulator.
11. Install the pressure regulator (if removed). Refer to the Pressure Regulator Replacement Section.
12. Install the Valve/Solenoid Assembly (if removed). Refer to the Valve/Solenoid Replacement Section.
13. Install the Compressor Cover. Refer to the Compressor Cover Replacement Section.

## **POWER CORD REPLACEMENT**

### **To Remove the Power Cord**

1. Remove the Rear Cabinet. Refer to the Rear Cabinet Replacement Section.
2. Slide the Front Cabinet forward until it is clear from the Base Cabinet.
3. Remove the Compressor Cover. Refer to the Compressor Cover Replacement Section.
4. Disconnect the main power wiring harness connector from its receptacle on the Power Switch wiring harness. Note the orientation of both the black and white Power Cord wires in the main power wiring harness connector.
5. Using an Amp terminal retractor tool, remove the female connectors of both the black and white Power Cord wires from the main power wiring harness connector.



***FIGURE AY: REMOVING THE POWER CORD WIRES FROM THE MAIN POWER WIRING HARNESS***

6. Using a Heyco tool, depress the locking tabs on the AC Power Cord strain relief grommet installed in the Base Cabinet.
7. Once the grommet is free of the Base Cabinet, remove the Power Cord.

---

**To Install the Power Cord**

1. Insert the Power Cord wires into the hole in the Base Cabinet.
2. Route the Power Cord wires to the main power wiring harness connector.
3. Align the female connectors on the end of the black and white Power Cord wires with their receptacles in the main power wiring harness connector.
4. Press each Power Cord wire female connector into the main power wiring harness connector until completely sealed.

**CAUTION**

*The black and white Power Cord wires MUST be inserted in the main power wiring harness connector in their original configuration. If they are reversed, damage to the unit will occur.*

5. Align the Power Cord strain relief grommet with the cutout in the Base Cabinet. Press the grommet into the Base Cabinet until completely seated. Using an Amp terminal retractor tool, remove the female connectors of both the black and white Power Cord wires from the main power wiring harness connector.
6. Plug the main power wiring harness connector into its receptacle on the Power Switch wiring harness.
7. Install the Compressor Cover. Refer to the Compressor Cover Replacement Section.
8. Slide the Front Cabinet onto the Base Cabinet.
9. Install the Rear Cabinet. Refer to the Rear Cabinet Replacement Section.

---

## BASE CABINET REPLACEMENT

### NOTE

*If care is taken during the following procedures, the Valve/Solenoid Assembly and the pressure regulator do not have to be removed. However, if these components are damaged during the procedure, they must be replaced.*

#### To Remove the Base Cabinet

1. Remove the Rear Cabinet. Refer to the Rear Cabinet Replacement Section.
2. Slide the Front Cabinet forward until it is clear from the Base Cabinet.
3. Remove Compressor Cover/Perforated Canopy. Refer to the Compressor Cover Replacement Section.
4. Remove Capacitor. Refer to the Motor Start/Run Capacitor Section.
5. Remove Compressor/motor assembly. Refer to the Compressor Assembly Replacement Section. Remove In-line Muffler. Refer to the In-line Muffler Replacement Section.
6. Remove Hour Meter. Refer to the Hour Meter Replacement Section.
7. Remove Sieve Canister Assembly. Refer to the Sieve Canister Assembly Replacement Section.
8. Remove Power Cord. Refer to the Power Cord Replacement Section.
9. Remove Base Cabinet and bottom pan.

#### To Install the Base Cabinet

1. All components have now been removed from the original Base Cabinet. To begin reassembly, place the Base Cabinet on a protected work surface. Follow the disassembly process in reverse order to reassemble the unit.

## M600/M605 CONCENTRATOR REPAIR & REPLACEMENT

### SECTION OVERVIEW

This chapter illustrates the repair and replacement procedures for the components of the M600/605 Millennium Oxygen Concentrators. Once repair is complete refer to the testing section for proper testing procedures.

#### WARNINGS

- *To prevent electrical shock, disconnect the electrical supply before attempting to make any device repairs to the Millennium Oxygen Concentrators.*
- *Use extreme caution when handling the Compressor/motor assembly Capacitor. The Capacitor can hold a substantial electrical charge until it is properly discharged.*
- *Avoid handling the molecular sieve material. Respironics recommends the return of the Sieve Canister Assembly to Respironics for any service that involves sieve material disposal.*
- *Even with the unit disconnected from the electrical supply, the Capacitor may still hold an electrical charge strong enough to cause serious bodily injury. DO NOT touch the Capacitor terminals simultaneously until the Capacitor has been completely discharged. Discharge the Capacitor by shorting the two posts with an insulated screw driver.*

#### CAUTION

- *Electronic components used in this unit are subject to damage from static electricity. Repairs made to this unit must be performed only in an antistatic, ESD-protected environment.*
- *During all repair and replacement procedures, assure that any connections that are broken during the process (fittings, tubing, and hoses) are reconnected securely.*
- *When using leak detector, be careful that it does not come in contact with any electrical components.*
- *The fuse on the power control board must be replaced with a fuse of the same rating as the original. Failure to do so will result in damage to the unit.*

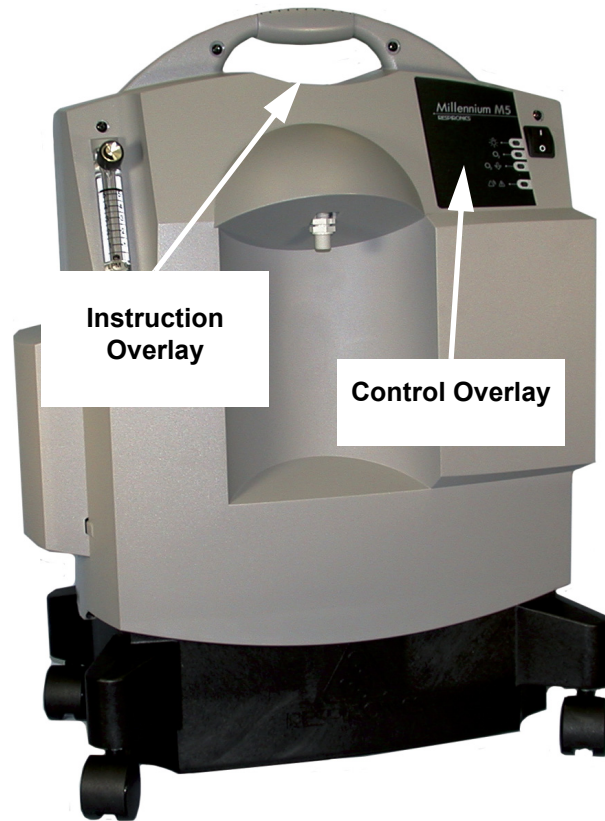
## OVERLAY REPLACEMENT

### To remove the Overlay

1. Starting at one corner, carefully peel the Overlay off of the cabinet.
2. Use a small amount of isopropyl alcohol applied to a cleaning cloth to remove any adhesive residue from the cabinet.

### To install the Overlay

1. Remove the protective backing from the Overlay.
2. Carefully align the Overlay with the applicable mounting area. Set the Overlay in place and, using a circular motion, firmly rub the Overlay until it is securely attached to the cabinet.



**FIGURE A: OVERLAY LOCATIONS**

## CASTER REPLACEMENT

### To remove the Casters

1. Place the unit on a protected work surface and carefully lay the unit over its Rear Cabinet.
2. While holding the unit firmly in place, grasp the Caster to be replaced and pull it firmly out of its receptacle in the molded base.



**FIGURE B: REMOVING THE CASTER**

### NOTE

*It may be necessary to insert a medium flat-blade screwdriver between the Caster and the molded base to “pry” the Caster from its receptacle. Once the Caster has been partially removed, a rubber mallet can be used to completely remove the Caster from its receptacle. If this is necessary, care should be taken to prevent damage to the molded case.*

3. If more than one Caster is to be replaced, repeat the procedure for each Caster to be replaced.

### To install the Casters

1. Align the Caster shaft with its receptacle in the molded base.
2. While holding the unit in place, firmly push the Caster into its receptacle until completely seated.

### NOTE

*It may be necessary to use a rubber mallet to gently tap the Caster into the molded base. If this is necessary, care should be taken to prevent damage to the molded case. In some cases, use water to lubricate the post.*

3. If more than one Caster is being replaced, repeat the procedure for each Caster being replaced.
4. Carefully return the unit to the upright position.



## BASE CABINET PAN REPLACEMENT

### To remove the Base Cabinet Pan

1. Place the unit on a protected work surface and carefully lay the unit over its Rear Cabinet.
2. Remove the six Phillips screws securing the Base Cabinet pan to the Base Cabinet.

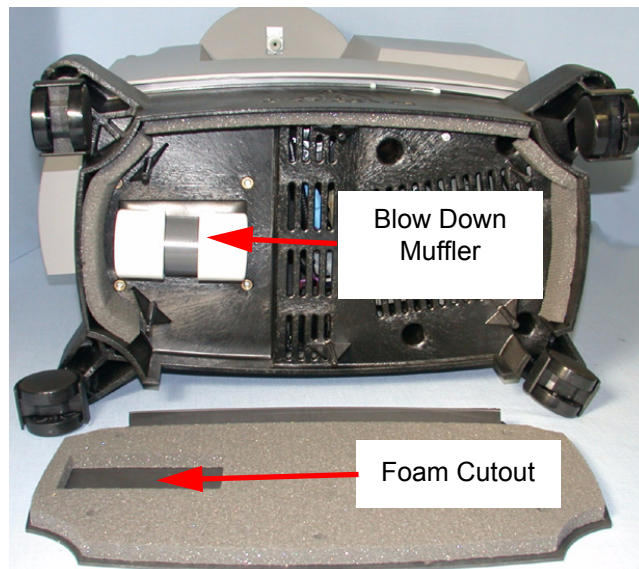


**FIGURE C: BASE CABINET PAN SCREW LOCATION**

3. Grasp the back edge of the Base Cabinet pan and remove it from the Base Cabinet.

### To install the Base Cabinet Pan

1. Position the Base Cabinet pan so the cut-out in the foam insulation aligns with the Blow Down Muffler.



**FIGURE D: BLOW DOWN MUFFLER AND FOAM CUTOUT**

2. Align the Base Cabinet pan with the Base Cabinet and set it into place.
3. Insert and gently tighten the six Phillips screws provided to secure the Base Cabinet pan to the Base Cabinet.

## REAR CABINET REPLACEMENT

### To remove the Rear Cabinet

1. Using a Phillips screwdriver, remove the six screws that secure the Rear Cabinet to the Front Cabinet.



**FIGURE E: FRONT CABINET SCREW LOCATIONS**

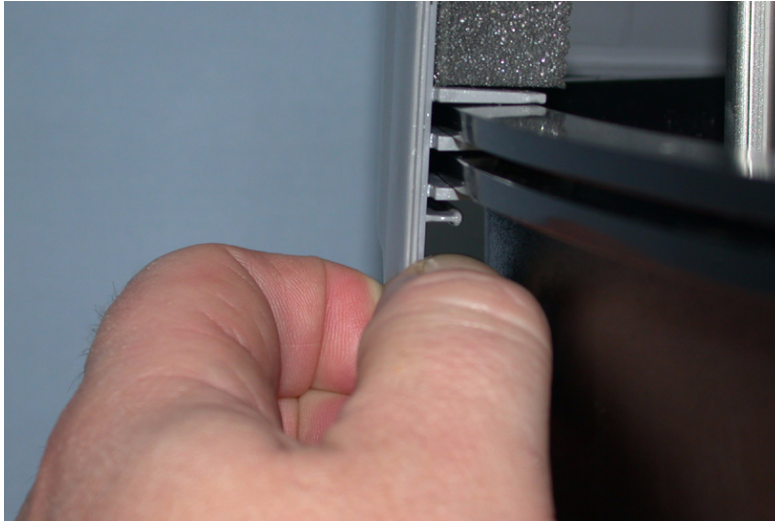
2. Grasp the Rear Cabinet firmly then slide it toward the back of the unit until it is clear of the guide slot on the Base Cabinet. Once clear of the guide slot, the Rear Cabinet can be lifted away from the unit.

**To install the Rear Cabinet**

**NOTE**

*The Base Cabinet has a guide slot to ensure proper alignment of the rear and Front Cabinets. The rear and Front Cabinets MUST be properly aligned with the guide slot to ensure correct installation.*

1. Align the ridges on the Rear Cabinet with the guide slot in the Base Cabinet.



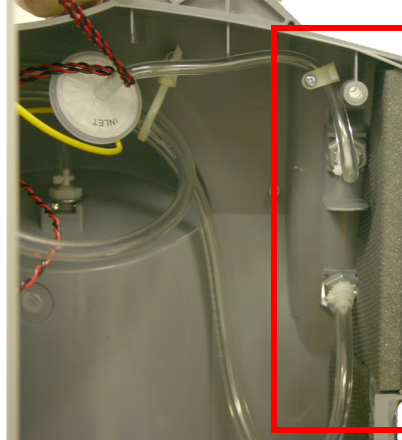
**FIGURE F: GUIDE SLOT**

2. Once the guide slot and ridges are correctly aligned, hold the Front Cabinet in place while sliding the Rear Cabinet onto the Base Cabinet.
3. Using a Phillips screwdriver, install and secure the six mounting screws securing the Rear Cabinet to the Front Cabinet.
4. Torque the six screws to  $15 \pm 1$  inch lbs.

## FLOW METER REPLACEMENT

### To remove the Flow Meter

1. Remove the Rear Cabinet. Refer to the Rear Cabinet Replacement Section.
2. Slide the Front Cabinet forward until it is clear from the Base Cabinet.
3. Working from inside the Front Cabinet, cut the cable ties then remove the pressure tubing from both fittings on the Flow Meter by pulling the tubing from each fitting.



**FIGURE G: VIEW OF FLOW METER FROM INSIDE THE FRONT CABINET**

### NOTE

*The pressure tubing connected to the top fitting on the Flow Meter is connected to the bacteria filter. The pressure tubing connected to the bottom fitting is connected to the OPI sensor for Model 605, or the 1/2" tubing in the wiring harness for Model 600.*

4. While holding the Flow Meter in place, remove the two speed nuts from the threaded fittings on the back of the Flow Meter.
5. Remove the Flow Meter from the Front Cabinet assembly by pulling it straight out from the Front Cabinet.

### To install the Flow Meter

1. Align the threaded fittings on the back of the supplied Flow Meter with the holes in the Front Cabinet.

### NOTE

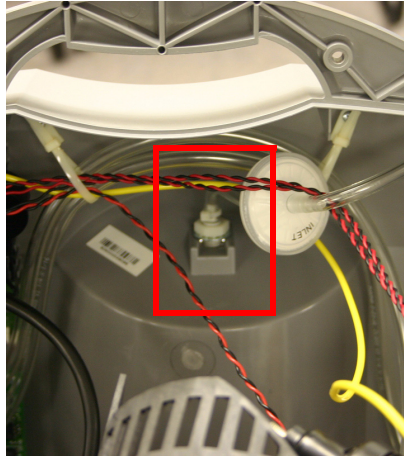
*The Flow Meter must be mounted with the shaft for the Flow Meter knob at the top.*

2. While holding the Flow Meter in place, install the support speed nuts to secure the Flow Meter to the Front Cabinet. Hand tighten the speed nuts.
3. Connect the pressure tubing to the fittings on the Flow Meter then secure the tubing with the cable ties provided.
4. Turn on the unit and check the flow tube connections for leaks.
5. If no leaks are detected, Turn off the unit and reassemble and test unit.

## DISS OUTLET FITTING REPLACEMENT

### To remove the DISS Outlet Fitting

1. Remove the Rear Cabinet. Refer to the Rear Cabinet Replacement Section.
2. Slide the Front Cabinet forward until it is clear from the Base Cabinet.
3. Cut the cable tie then remove the pressure tubing connected to the DISS outlet fitting by pulling it off the fitting.



**FIGURE H: VIEW OF DISS FITTING FROM INSIDE THE FRONT CABINET**

4. While holding the DISS outlet fitting in place, use an 11/16" wrench to loosen the nylon jam nut securing the DISS outlet fitting.
5. Remove the DISS outlet fitting from the Front Cabinet.



**FIGURE I: REMOVING THE DISS FITTING**

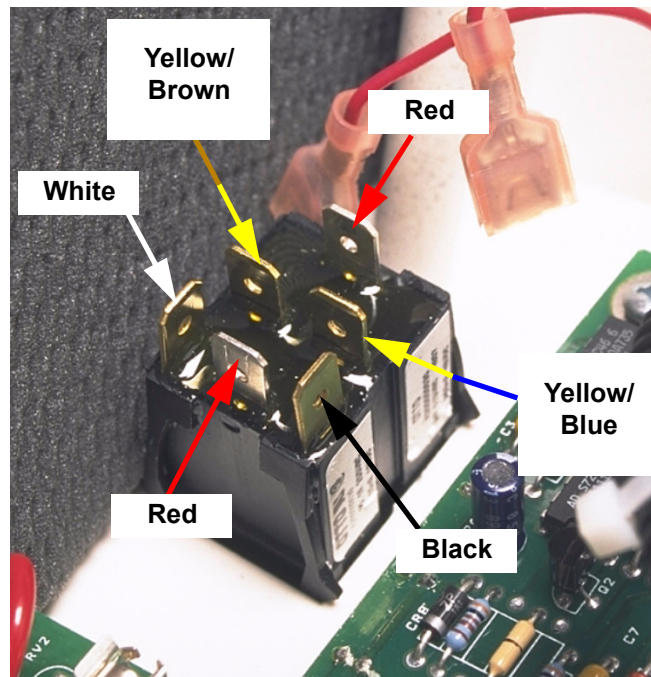
### To install the DISS Outlet Fitting

1. Align the DISS outlet fitting with the opening in the Front Cabinet. Insert the DISS outlet fitting into the opening.
2. While holding the DISS outlet fitting in place, install the new lock washer and nylon jam nut on the DISS outlet fitting. Use an 11/16" wrench to carefully tighten the nylon jam nut.
3. Connect the pressure tubing to the fittings on the DISS outlet fitting. Secure the tubing to the fitting with the cable tie provided.

## POWER SWITCH REPLACEMENT

### To remove the Power Switch

1. Remove the Rear Cabinet. Refer to the Rear Cabinet Replacement Section.
2. Slide the Front Cabinet forward until it is clear from the Base Cabinet.
3. Looking at the back of the Power Switch from inside the Front Cabinet, note the position and colors of the wires connected to the terminals on the Power Switch.



**FIGURE J: CORRECT CONNECTION OF THE WIRES TO THE POWER SWITCH**

### CAUTION

*Except for the two red wires that are interchangeable, the wires must be connected to the Power Switch as shown. Failure to do so will result in damage to the unit.*

4. Using needle nose pliers, remove the wires from the Power Switch terminals. Using your fingers or a small flat-blade screwdriver, depress the latches on each corner of the Power Switch.

5. While depressing the latches, pull the Power Switch out through the Front Cabinet.



**FIGURE K: REMOVAL OF THE POWER SWITCH**

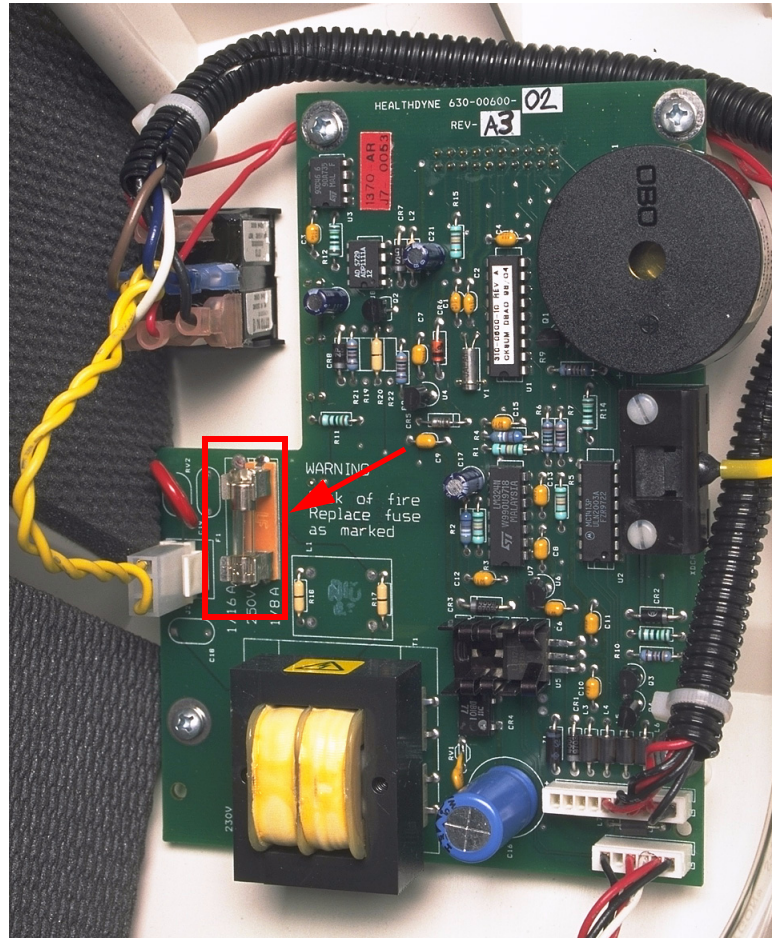
### **To install the Power Switch**

1. Orient the Power Switch so that the single terminal is at the top. Align the Power Switch with the opening in the Front Cabinet assembly. Press the Power Switch into the Front Cabinet assembly until all four latches on the Power Switch lock in place.
2. Install the wires onto the terminals of the Power Switch. Ensure that they are installed in their original position.

## MAIN PCB FUSE REPLACEMENT

### To remove the Fuse

1. Remove the Rear Cabinet. Refer to the Rear Cabinet Replacement Section.
2. Slide the Front Cabinet forward until it is clear from the Base Cabinet.
3. Using a fuse extractor, remove the fuse from its receptacle on the Main PCB.



**FIGURE L: FUSE LOCATION**

### To install the Fuse

1. Align the fuse with its receptacle on the Main PCB.
2. Carefully press the fuse into its receptacle until completely seated.



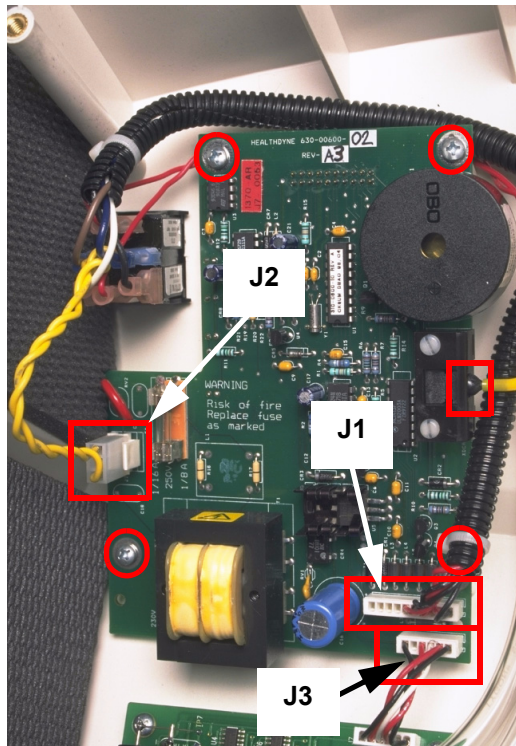
## MAIN PCB REPLACEMENT

### CAUTION

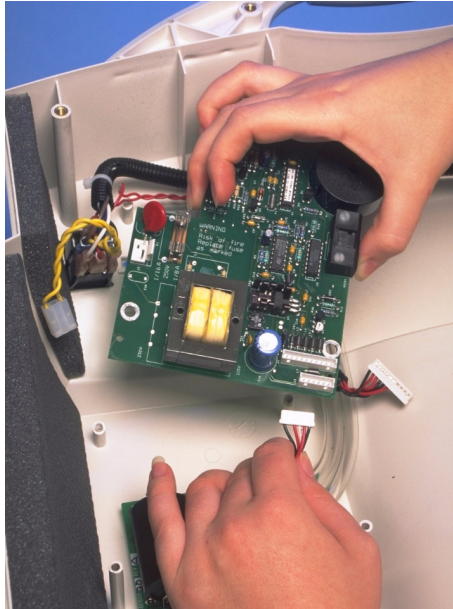
*Electronic components used in this unit are subject to damage from static electricity. Repairs made to this unit must be performed only in an antistatic, ESD-protected environment.*

#### To remove the Main PCB

1. Remove the Rear Cabinet. Refer to the Rear Cabinet Replacement Section.
2. Slide the Front Cabinet forward until it is clear from the Base Cabinet.
3. While holding the pressure transducer, remove the thin yellow pressure tubing from the pressure transducer by carefully pulling the tubing off the fitting.
4. Remove the main power wiring harness connector from the J1 location on the Main PCB assembly by pulling the connector directly up from the J1 receptacle.
5. **For Model 605 units Only:** Remove the OPI wiring harness connector from the J3 location on the Main PCB assembly by pulling the connector directly up from the J3 receptacle.
6. Depress the locking tab, then remove the Power Switch wiring harness connector from the J2 location on the Main PCB by pulling the connector directly up from the J2 receptacle.
7. Using a Phillips screwdriver, remove the four screws securing the Main PCB assembly to the Front Cabinet. While holding the wiring harness out of the way, remove the Main PCB assembly from the Front Cabinet assembly.



**FIGURE M: CONNECTIONS AND MOUNTING SCREW LOCATIONS**



**FIGURE N: REMOVING THE MAIN PCB**

#### **To install the Main PCB**

1. While holding the wiring harnesses out of the way, align the holes in the Main PCB assembly with the standoffs on the Front Cabinet assembly.
2. Insert then tighten the four screws provided to secure the Main PCB assembly to the Front Cabinet assembly.
3. Align the connector on the Power Switch wiring harness with the J2 receptacle on the Main PCB assembly. Carefully press the connector onto the receptacle until completely seated.
4. **For Model 605 units Only:** Align the connector on the short OPI wiring harness with the J3 receptacle on the Main PCB assembly. Carefully press the connector onto the receptacle until completely seated.
5. Align the connector on the main power wiring harness with the J1 receptacle on the Main PCB assembly. Carefully press the connector onto the receptacle until completely seated.
6. While holding the pressure transducer, install the thin yellow pressure tubing onto the pressure transducer by firmly and carefully pushing the tubing onto the fitting.

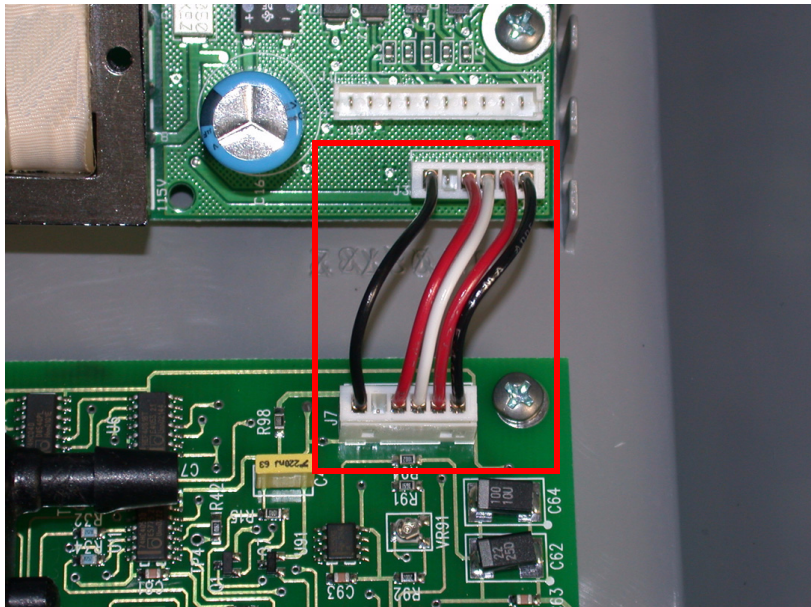
## OPI WIRING HARNESS REPLACEMENT (MODEL M605 ONLY)

### CAUTION

*Electronic components used in this unit are subject to damage from static electricity. Repairs made to this unit must be performed only in an antistatic, ESD-protected environment.*

#### To remove the OPI Wiring Harness

1. Remove the Rear Cabinet. Refer to the Rear Cabinet Replacement Section.
2. Slide the Front Cabinet forward until it is clear from the Base Cabinet.
3. Remove the OPI wiring harness connector from the J3 location on the Main PCB assembly by pulling the connector directly up from the J3 receptacle.
4. Remove the OPI wiring harness connector from the J7 location on the OPI board by pulling the connector directly up from the J7 receptacle.



**FIGURE O: OPI WIRING HARNESS**

#### To install the OPI Wiring Harness

1. Align the connector on the OPI board wiring harness with the J7 receptacle on the OPI board. Carefully press the connector onto the receptacle until completely seated.
2. Align the connector on the OPI wiring harness with the J3 receptacle on the Main PCB assembly. Carefully press the connector onto the receptacle until completely seated.

## OPI BOARD REPLACEMENT (MODEL M605 ONLY)

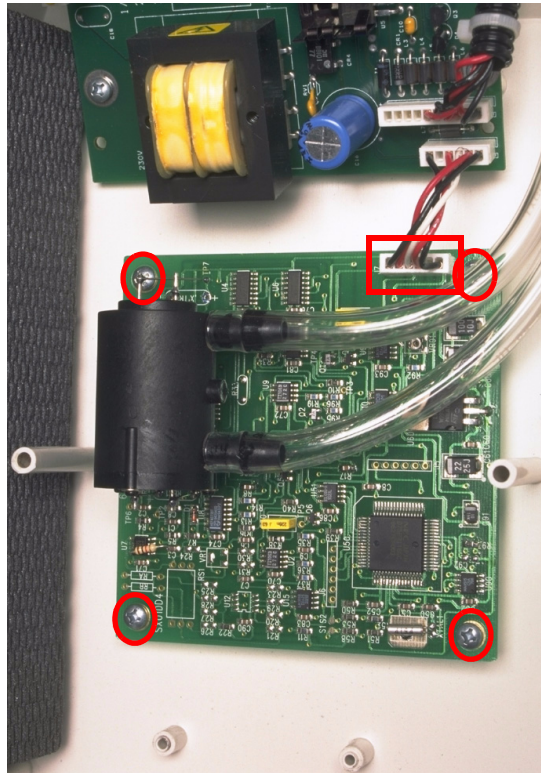
### To remove the OPI Board

1. Remove the Rear Cabinet. Refer to the Rear Cabinet Replacement Section.
2. Slide the Front Cabinet forward until it is clear from the Base Cabinet.
3. Remove the OPI wiring harness connector from the J7 location on the OPI board by pulling the connector directly up from the J7 receptacle.
4. While holding the oxygen sensor, remove the pressure tubing from the sensor by carefully prying the tubing off both oxygen sensor fittings.

### NOTE

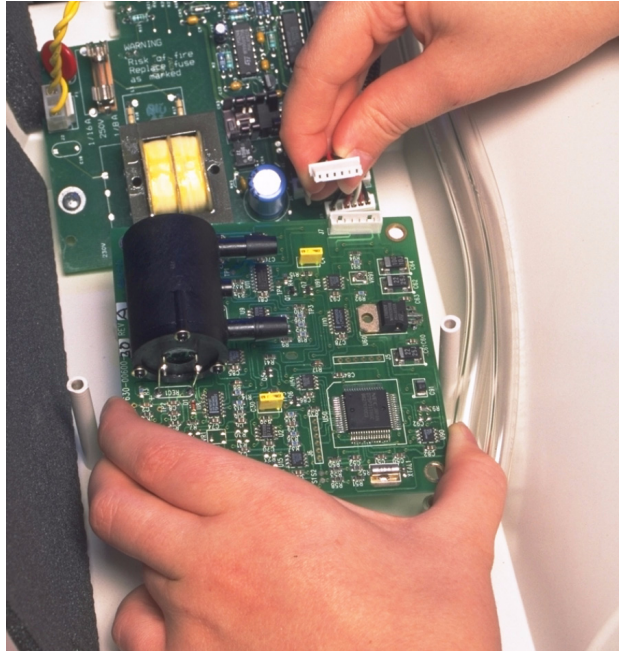
*The pressure tubing from the Flow Meter is connected to the top fitting on the oxygen sensor. The pressure tubing connected to the pressure regulator on the Sieve Canister Assembly is connected to the bottom fitting on the oxygen sensor.*

5. Using a Phillips screwdriver, remove the four screws securing the OPI board to the Front Cabinet.



**FIGURE P: CONNECTIONS AND MOUNTING SCREW LOCATIONS**

6. While holding the wiring harness out of the way, remove the OPI board from the Front Cabinet.



**FIGURE Q: REMOVING THE OPI BOARD**

#### To install the OPI Board

1. Align the holes in the OPI board with the standoffs on the Front Cabinet.
2. Insert then tighten the four screws provided to secure the OPI board to the Front Cabinet.
3. While holding the oxygen sensor, install the pressure tubing on the oxygen sensor by carefully pushing the tubing onto the oxygen sensor fittings.
4. Align the connector on the OPI wiring harness with the J7 receptacle on the OPI board. Carefully press the connector onto the receptacle until completely seated.

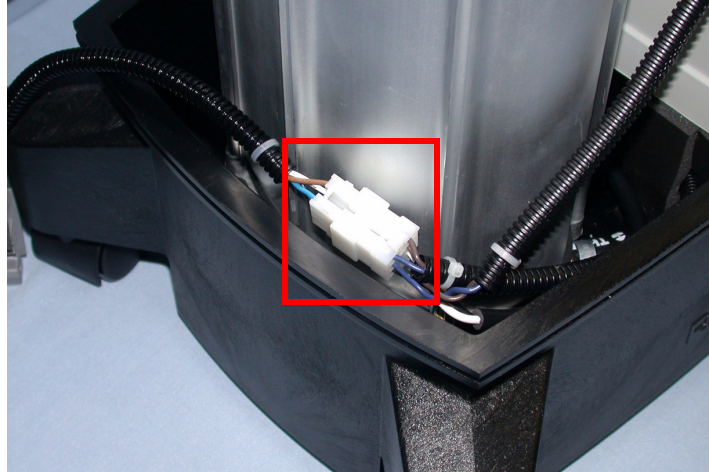
#### NOTE

*Once the unit is reassembled, verify that there are no O<sub>2</sub> leaks. Set the Flow Meter to 0 lpm. Ensure the “no flow” alert activates. The alert should activate. If not, check for leaks at newly installed OPI board.*

## POWER SWITCH WIRING HARNESS REPLACEMENT

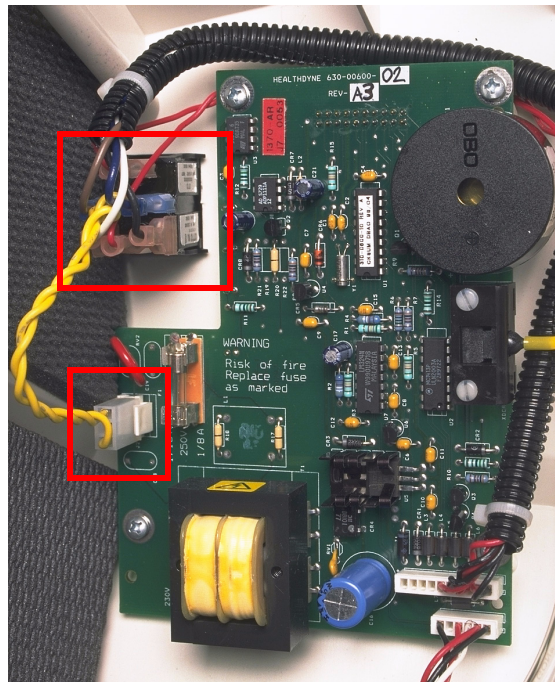
### To remove the Power Switch Wiring Harness

1. Remove the Rear Cabinet. Refer to the Rear Cabinet Replacement Section.
2. Slide the Front Cabinet forward until it is clear from the Base Cabinet.
3. Disconnect the male connector on the Power Switch wiring harness from this female connector on the main power wiring harness.



**FIGURE R: LOCATION OF THE CONNECTOR**

4. Remove the female connector from the (J2) location on the Main PCB.



**FIGURE S: MAIN PCB (J2) AND POWER SWITCH LOCATIONS**

5. Looking at the back of the Power Switch from inside the Front Cabinet, note the position and colors of the wires connected to the terminals on the Power Switch.

**CAUTION**

*Except for the two red wires that are interchangeable, the wires must be connected to the Power Switch as shown. Failure to do so will result in damage to the unit.*

6. Using needle nose pliers, remove the connectors from the Power Switch terminals.

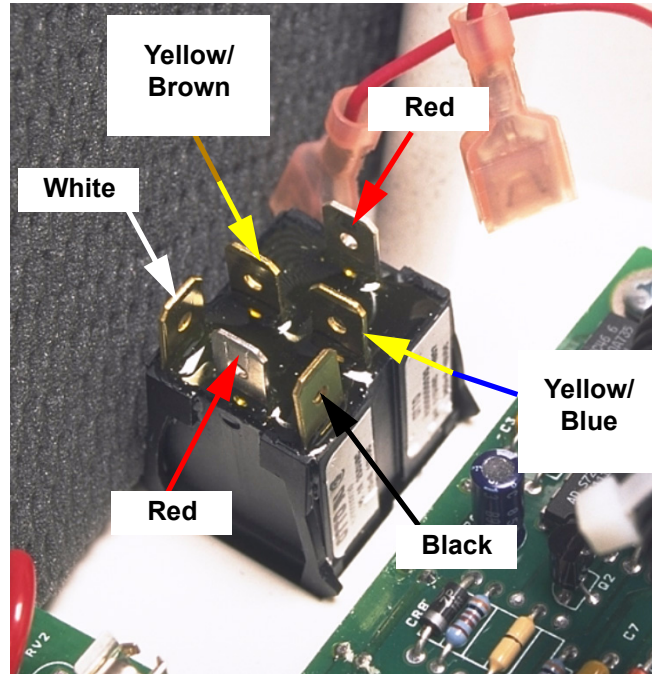
**NOTE**

*The two red wires from the O<sub>2</sub>/solenoid/battery wiring harness do not have to be disconnected from the Power Switch.*

7. Remove the screws that secure the screw down cables ties to the Front Cabinet.
8. Either feed the Power Switch wiring harness through the screw down cable ties or, if new screw down cable ties are available, cut the cable ties and remove the Power Switch wiring harness.

## To install the Power Switch Wiring Harness

1. Either feed the Power Switch wiring harness through the original screw down cable ties, or if new screw down cable ties are available, loosely install four cable ties grouping the Power Switch wiring harness, the O<sub>2</sub>/solenoid/battery wiring harness, and the clear and yellow pressure tubing together.
2. Install the connectors onto the proper terminals of the Power Switch. Ensure that they are installed in their original position.



**FIGURE T: POWER SWITCH TERMINAL LOCATIONS**

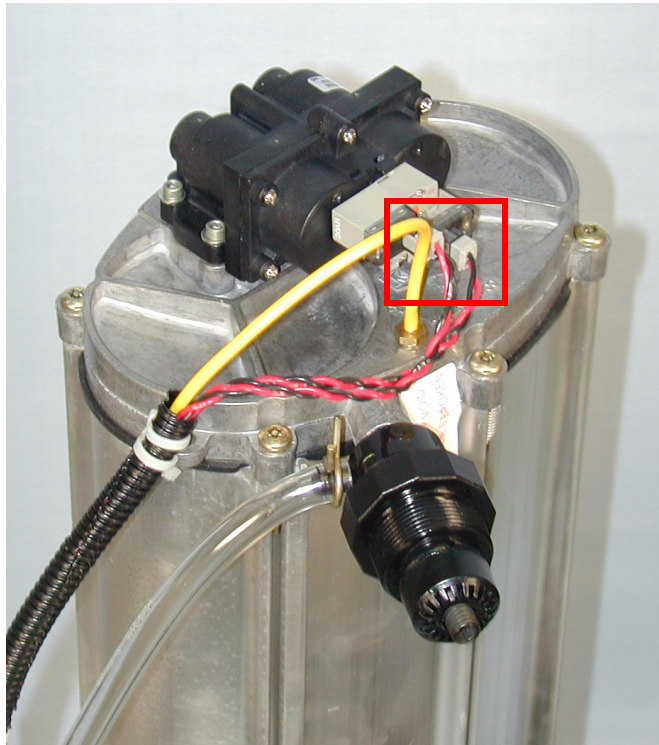
3. Install the female connector onto the (J2) location on the Main PCB.
4. Position the screw down cable ties at their mounting posts then secure each using the original screws. Tighten the screw down cable ties.
5. Connect the male connector on the Power Switch wiring harness from the female connector on the main power wiring harness.



## O<sub>2</sub>/SOLENOID/BATTERY WIRING HARNESS

### To remove the O<sub>2</sub>/Solenoid/Battery Wiring Harness

1. Remove the Rear Cabinet. Refer to the Rear Cabinet Replacement Section.
2. Slide the Front Cabinet forward until it is clear from the Base Cabinet.
3. Remove the battery connector from the battery.
4. Remove the two connectors from the Valve/Solenoid Assembly.



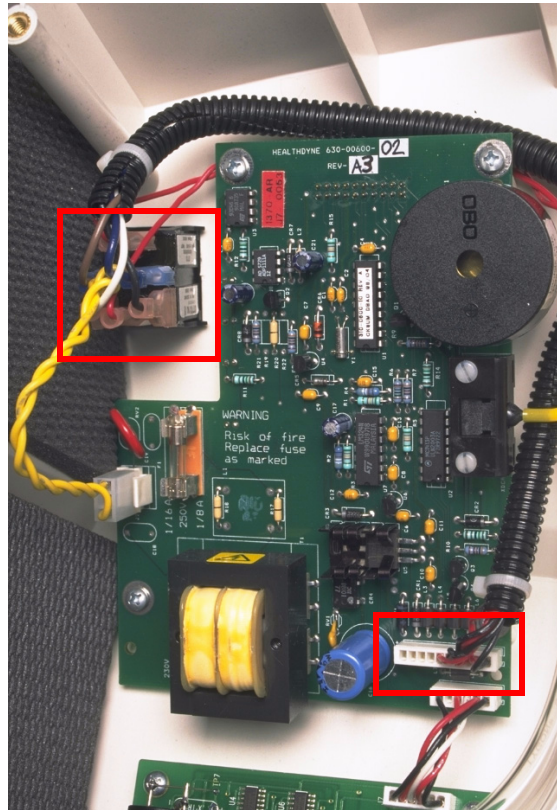
**FIGURE U: VALVE/SOLENOID CONNECTIONS**

5. Remove the yellow pressure tubing from the top of the Sieve Canister.
6. Remove the pressure tubing from the pressure regulator assembly.
7. Remove the two red wires connected to the Power Switch.

### NOTE

*The two red/black wiring harnesses are interchangeable.*

8. Remove the O<sub>2</sub>/solenoid/battery wiring harness connector from the J1 location on the OPI Board.



**FIGURE V: POWER SWITCH AND MAIN PCB J1 LOCATIONS**

9. Remove the screws that secure the screw down cable ties to the Front Cabinet.
10. Either feed the O<sub>2</sub>/solenoid/battery wiring harness through the screw down cable ties or, if new screw down cable ties are available, cut the cable ties and remove the O<sub>2</sub>/solenoid/battery wiring harness.
11. Note the location at which the battery wires exit the large convoluted tubing. Cut the cable ties and remove the O<sub>2</sub>/solenoid/battery wiring harness from the convoluted tubing.

### To install the O<sub>2</sub>/Solenoid/Battery Wiring Harness

1. Install the O<sub>2</sub>/solenoid/battery wiring harness into the large convoluted tubing. Ensure that the battery wires exit the large convoluted tubing at their original location. Secure the convoluted tubing with four cable ties.
2. Either feed the O<sub>2</sub>/solenoid/battery wiring harness through the original screw down cable ties, or if new screw down cable ties are available, loosely install four cable ties grouping the O<sub>2</sub>/solenoid/battery wiring harness, Power Switch wiring harness, along with the clear and yellow pressure tubing together.
3. Install the O<sub>2</sub>/solenoid/battery wiring harness connector onto the J1 location on the OPI board.
4. Install the two red wires from the O<sub>2</sub>/solenoid/battery wiring harness to the Power Switch.
5. Position the screw down cable ties at their mounting posts then secure each using the original screws. Tighten the screw down cable ties.
6. Install the two connectors from the O<sub>2</sub>/solenoid/battery wiring harness on the Valve/Solenoid Assembly.
7. Install the battery connector on the battery.

## FRONT CABINET REPLACEMENT

### To remove the Front Cabinet

1. Remove the Rear Cabinet. Refer to the Rear Cabinet Replacement Section.
2. Slide the Front Cabinet forward until it is clear from the Base Cabinet.
3. Remove the Flow Meter. Refer to the Flow Meter Replacement Section.
4. Remove the DISS outlet fitting. Refer to the DISS Outlet Fitting Replacement Section.
5. Remove the Power Switch harness. Refer to the Power Switch Wiring Harness Replacement Section.
6. Remove the O<sub>2</sub>/solenoid/battery wiring harness. Refer to the O<sub>2</sub>/Solenoid/Battery Wiring Harness Section.
7. Remove the Power Switch. Refer to the Power Switch Replacement Section.
8. Remove the OPI Wiring Harness. Refer to the OPI Wiring Harness Replacement (Model M605 Only) Section.
9. Remove the Main PCB. Refer to the Main PCB Replacement Section.
10. Remove the OPI board. Refer to the OPI Board Replacement (Model M605 Only) Section.

### To install the Front Cabinet

1. Remove the protective backing from the control Overlay. Carefully aligning the Overlay apply it to the Front Cabinet.
2. Position the Front Cabinet face down on a protected work surface that will not damage the Front Cabinet.
3. Install the OPI Board. Refer to the OPI Board Replacement (Model M605 Only) Section.
4. Install the Main PCB. Refer to the Main PCB Replacement Section.
5. Install the OPI Wiring Harness. Refer to the OPI Wiring Harness Replacement (Model M605 Only) Section.
6. Install the Power Switch. Refer to the Power Switch Replacement Section.
7. Install the O<sub>2</sub>/solenoid/battery wiring harness. Refer to the O<sub>2</sub>/Solenoid/Battery Wiring Harness Section.
8. Install the Power Switch harness. Refer to the Power Switch Wiring Harness Replacement Section.
9. Install the DISS outlet fitting. Refer to the DISS Outlet Fitting Replacement Section.
10. Install the Flow Meter. Refer to the Flow Meter Replacement Section.
11. Slide the Front Cabinet onto the Base Cabinet.

12. Install the Rear Cabinet. Refer to the Rear Cabinet Replacement Section.



**FIGURE W: FRONT CABINET SCREW LOCATIONS**

## COOLING FAN REPLACEMENT

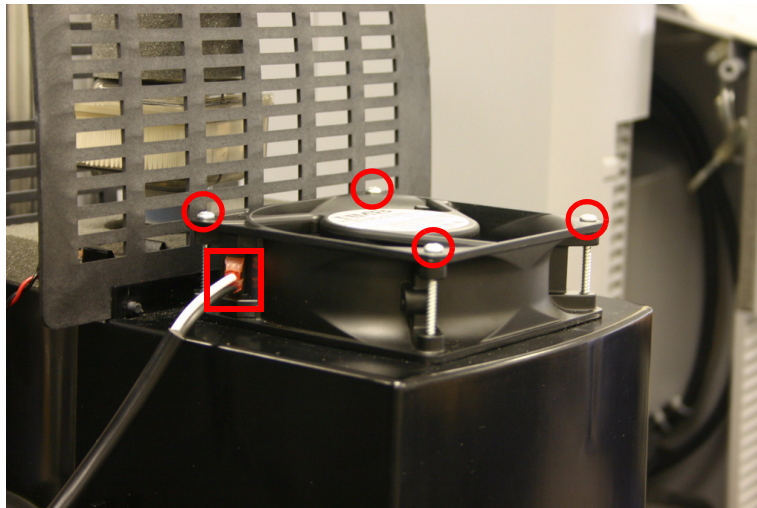
### To remove the Cooling Fan

1. Remove the Rear Cabinet. Refer to the Rear Cabinet Replacement Section.
2. Slide the Front Cabinet forward until it is clear from the Base Cabinet.
3. Remove the two wires from the terminals located on the side of the cooling fan.

### NOTE

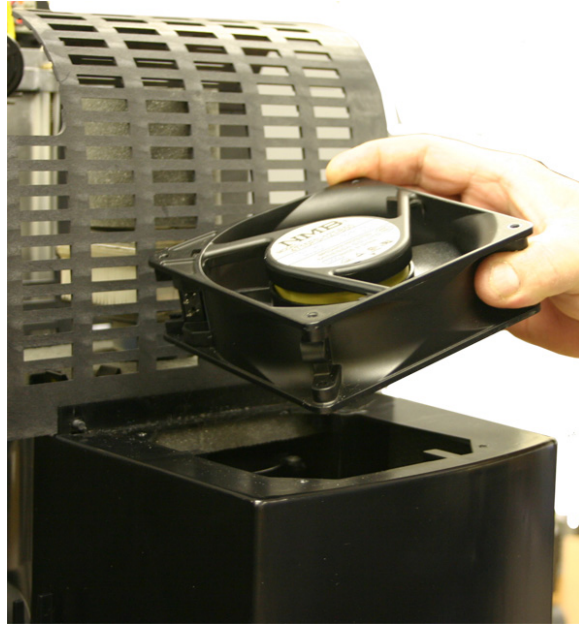
*The two wires are interchangeable.*

4. Using a small, thin shaft Phillips screwdriver, remove the four screws securing the cooling fan to the Compressor Cover.



**FIGURE X: WIRES AND SCREW LOCATIONS**

5. While holding the Compressor Cover in place, lift the fan up and away from the Compressor Cover.



**FIGURE Y: REMOVING THE FAN**

### To install the Cooling Fan

1. Align the cooling fan with the holes in the Compressor Cover.

#### **NOTE**

*The fan must be installed so the terminals are oriented towards the front and center of the unit.*

2. Insert then tighten the four screws to secure the fan to the Compressor Cover.
3. Connect the fan wires to the terminals on the side of the cooling fan.

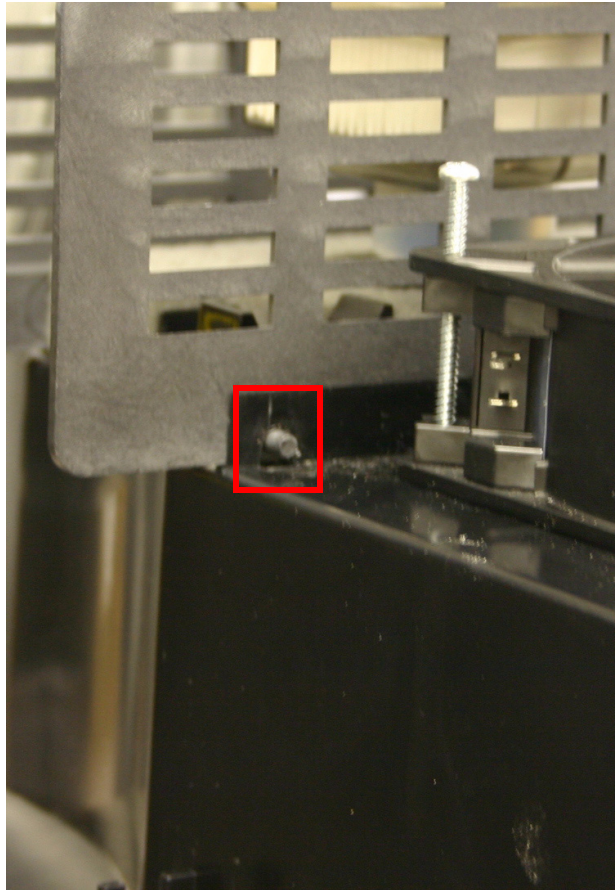
#### **NOTE**

*Ensure that the convoluted tubing covering the fan wires is still properly seated in the wire holder built into the front of the Compressor.*

## PERFORATED CANOPY REPLACEMENT

### To remove the Perforated Canopy

1. Remove the Rear Cabinet. Refer to the Rear Cabinet Replacement Section.
2. Slide the Front Cabinet forward until it is clear from the Base Cabinet.
3. Remove the 9-volt alarm battery from its holder.
4. Press inward on the bottom of each side of the Perforated Canopy until the locating posts are clear of the holes in the Compressor Cover.



**FIGURE Z: LOCKING POST LOCATION**

5. Lift the Perforated Canopy up and away from the Compressor Cover.

### To install the Perforated Canopy

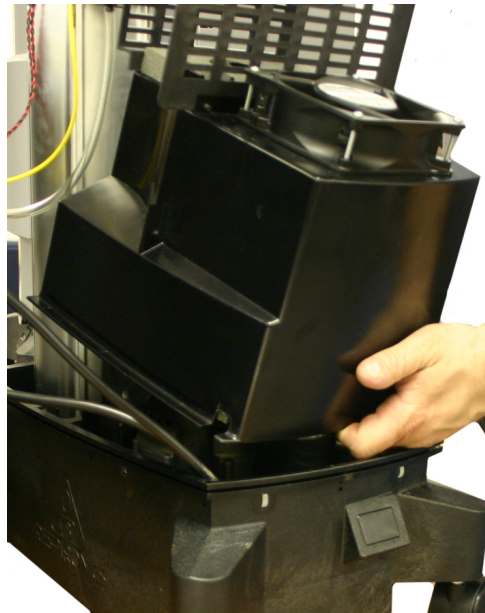
1. While exerting slight inward pressure on the sides of the Perforated Canopy, align the locating posts with the holes in the Compressor Cover.
2. Release the pressure, then ensure that the locating posts have locked in place in the Compressor Cover.
3. Install the 9-volt battery in its holder.



## COMPRESSOR COVER REPLACEMENT

### To remove the Compressor Cover

1. Remove the Rear Cabinet. Refer to the Rear Cabinet Replacement Section.
2. Slide the Front Cabinet forward until it is clear from the Base Cabinet.
3. Remove the cooling fan. Refer to the Cooling Fan Replacement Section.
4. Remove the Perforated Canopy. Refer to the Perforated Canopy Replacement Section.
5. Remove the convoluted tubing containing the fan wires from the wire holder built into the front of the Compressor Cover.
6. Remove the 9-volt battery.
7. If the Compressor Cover has two Phillips Head screws securing the cover to the Base Cabinet, remove them at this time. If the cover does not have screws securing the cover to the base then proceed to Step 8.
8. Lift the Compressor Cover housing straight up and then away from the Base Cabinet.



**FIGURE AA: REMOVING THE COMPRESSOR COVER (COMPRESSOR COVER SHOWN WITH FAN INSTALLED)**

### To install the Compressor Cover

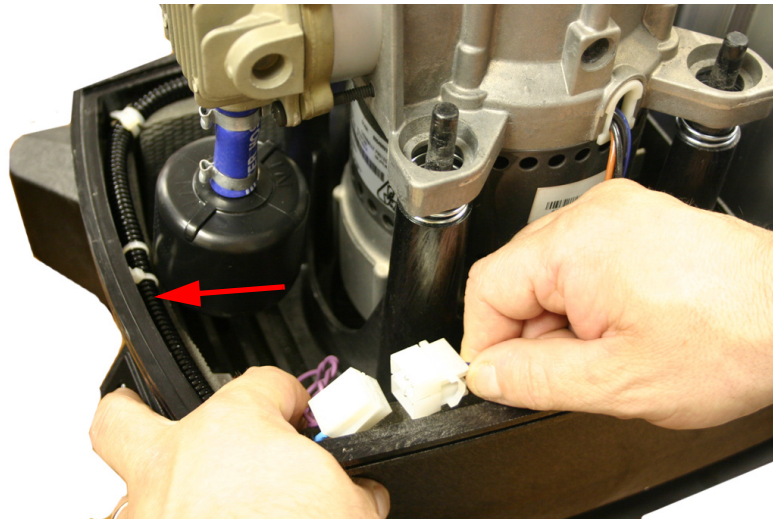
1. Position the Compressor Cover so the built-in wire holder is facing the front of the unit.
2. Align the round hole in the top of the Compressor Cover housing with the inlet port of the Compressor assembly.
3. Set the Compressor Cover into place on the Base Cabinet. Ensure that the bottom of the Compressor Cover housing is correctly seated on the Base Cabinet.
4. If the Compressor Cover had two Phillips Head screws securing the cover to the Base Cabinet, install them at this time. If the cover did not have screws securing the cover to the base then proceed to Step 5.
5. Insert the convoluted tubing containing the fan wires into the built-in wire holder on the front of the Compressor Cover.

## MAIN POWER WIRING HARNESS REPLACEMENT

### WARNING

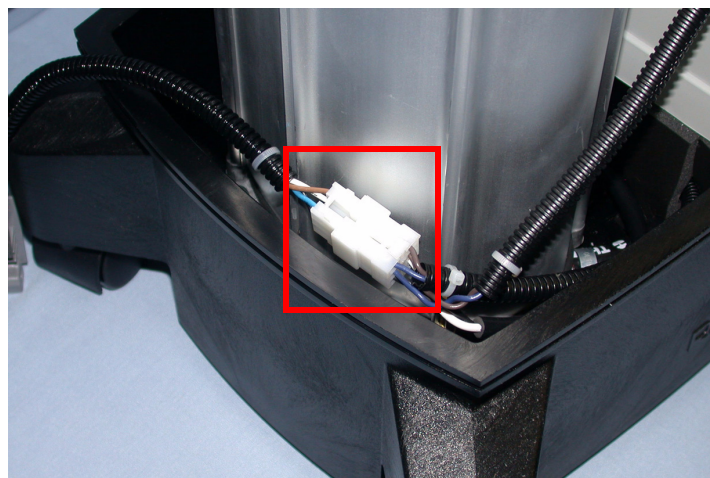
*Make sure the AC power is disconnected.*

To remove the Main Power Wiring Harness



**FIGURE AB: LOCATION OF THE MAIN POWER WIRING HARNESS**

1. Remove the Rear Cabinet. Refer to the Rear Cabinet Replacement Section.
2. Slide the Front Cabinet forward until it is clear from the Base Cabinet.
3. Remove the Compressor Cover. Refer to the Compressor Cover Replacement Section.
4. Disconnect the female connector on the main power wiring harness from the male connector on the Power Switch harness.



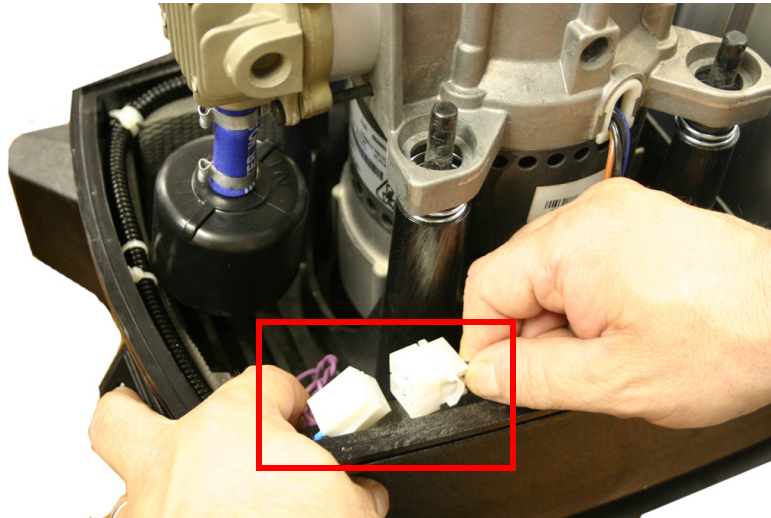
**FIGURE AC: DISCONNECTING THE MAIN POWER WIRING HARNESS FROM THE POWER SWITCH WIRING HARNESS**

5. Note the position of the Power Cord wires in the main power harness female connector. Using an amp terminal retractor, remove the Power Cord wire from the connector.
6. Note the routing of the main power wiring harness and the location of the cable ties securing the harness to the Base Cabinet. Cut the cable ties.
7. Remove the two connectors from the Hour Meter.

## NOTE

*The wires connected to the Hour Meter are interchangeable.*

8. Disconnect the female connector of the main power wiring harness from the male connector on the Compressor wires.



**FIGURE AD: DISCONNECTING THE MAIN POWER WIRING HARNESS FROM THE COMPRESSOR WIRING HARNESS**

### To install the Main Power Wiring Harness

1. Install the female connector of the main power wiring harness onto the male connector on the Compressor wires.
2. Install the two Hour Meter wires onto the Hour Meter.
3. Route the main power wiring harness along the inside of the Base Cabinet. Secure the main power wiring harness to the Base Cabinet using three cable ties.
4. Install the Power Cord wire connectors in their original position in the main power harness female connector.
5. Install the female connector on the main power wiring harness onto the male connector on the Power Switch wiring harness.

## MOTOR START/RUN CAPACITOR

### To remove the Motor Start/Run Capacitor

1. Remove the Rear Cabinet. Refer to the Rear Cabinet Replacement Section.
2. Slide the Front Cabinet forward until it is clear from the Base Cabinet.
3. Remove the Compressor Cover. Refer to the Compressor Cover Replacement Section.



**FIGURE AE: CAPACITOR LOCATION**

4. Using insulated needle-nose pliers, carefully remove the female connectors on the Capacitor wires from the two Capacitor terminals.

### CAUTION

*Short the terminals of the Capacitor to discharge.*

5. After the Capacitor is discharged, lift the Capacitor up and out of the molded base.

### To install the Motor Start/Run Capacitor

1. Slide the Capacitor into position between the foam insulation and the Compressor assembly standoff.
2. Connect the Capacitor wires to the terminals on the Capacitor.
3. Make sure the Capacitor terminals are parallel to the rear wall in the Base Cabinet.

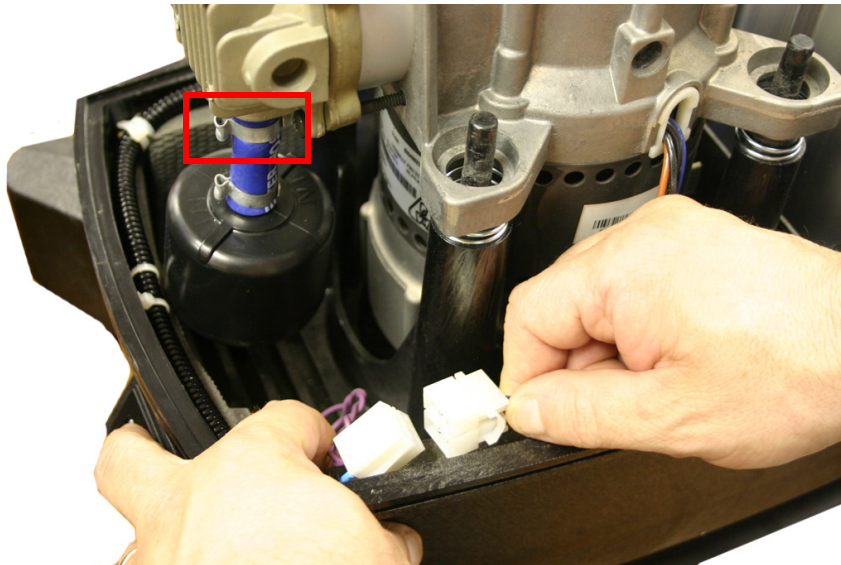
## COMPRESSOR ASSEMBLY REPLACEMENT

### WARNING

*Ensure that the unit is disconnected from the AC power source before beginning this procedure.*

#### To remove the Compressor Assembly

1. Remove the Rear Cabinet. Refer to the Rear Cabinet Replacement Section.
2. Slide the Front Cabinet forward until it is clear from the Base Cabinet.
3. Remove the Compressor Cover. Refer to the Compressor Cover Replacement Section.
4. Disconnect the Compressor assembly harness from the main power cabinet wiring harness by depressing the locking tabs and separating the connectors.



**FIGURE AF: DISCONNECTING THE COMPRESSOR ASSEMBLY WIRING HARNESS AND THE LOCATION OF THE ONE-EARED CLAMP**

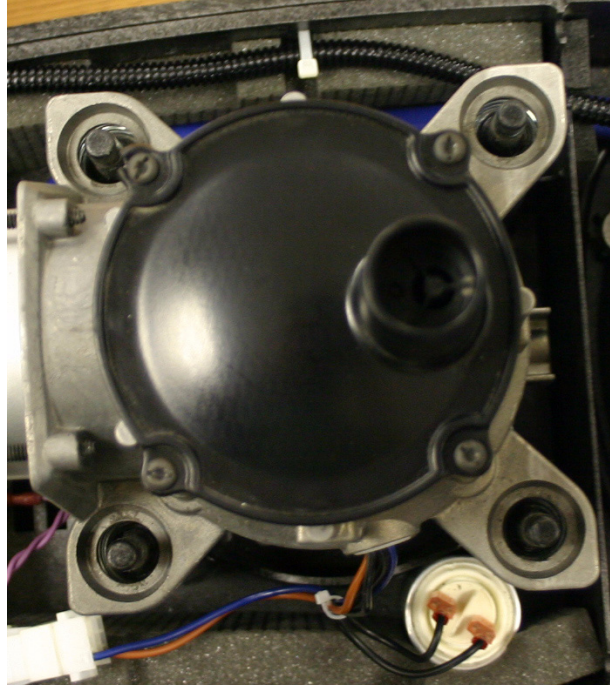
5. Disconnect the wires from the Capacitor terminals.

### NOTE

*The wires connected to the Capacitor are interchangeable.*

6. Using a crimping clamp tool or diagonals, cut the one-eared clamp securing the pressure tubing to the outlet port of the Compressor assembly. Remove the pressure tubing from the Compressor assembly outlet port.

7. Lift the Compressor assembly up from the standoffs and helical springs.



**FIGURE AG: TOP VIEW OF THE COMPRESSOR ON THE MOUNTING ROD AND SPRINGS**

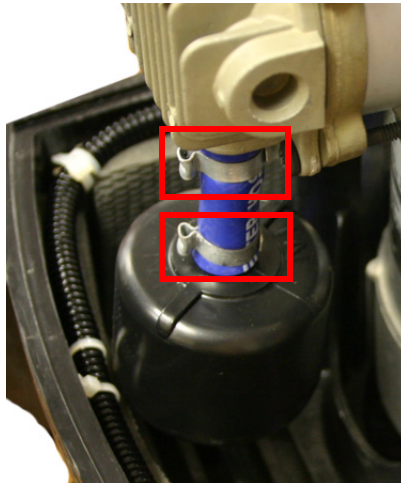
**To install the Compressor Assembly**

1. Align the Compressor/motor assembly with the standoffs and helical springs. Set the Compressor assembly in place.
2. Slide the supplied one-eared clamp onto the pressure tubing. Align the tubing with the Compressor assembly outlet port. Slide the tubing onto the ports.
3. Slide the one-eared clamp into position on the pressure tubing. Using a crimping clamp tool or diagonals, firmly “pinch” the one-eared clamp to secure the pressure tubing.
4. Confirm that the In-line Muffler is not touching the side wall of the Base Cabinet or main power wiring harness.
5. Install the Capacitor wire connectors onto the terminals of the Capacitor.
6. Align the female connector on the Compressor assembly wiring harness with the connector on the main power wiring harness. Press the connectors together until completely seated and locked together.

## IN-LINE MUFFLER REPLACEMENT

### To remove the In-line Muffler

1. Remove the Rear Cabinet. Refer to the Rear Cabinet Replacement Section.
2. Slide the Front Cabinet forward until it is clear from the Base Cabinet.
3. Remove the Compressor Cover. Refer to the Compressor Cover Replacement Section.
4. Using a crimping clamp tool or diagonals, cut the two one-eared clamps between the Compressor head and In-line Muffler.
5. Straighten the pressure hose to gain access to the bottom on the In-line Muffler. Cut the one-eared clamp then remove the pressure hose.



**FIGURE AH: LOCATION OF THE ONE-EARED CLAMPS**

6. Remove the In-line Muffler.

## To install the In-line Muffler

1. Slide a new one-eared clamp onto the existing 12" pressure hose. Attach the pressure hose to the bottom In-line Muffler.



**FIGURE A1: CORRECT ORIENTATION OF THE IN-LINE MUFFLER**

2. Using a crimping tool or diagonals, firmly "pinch" the one-eared clamp to securely fasten the pressure tubing to the outlet port of the In-line Muffler.
3. Attach the 1 3/4" pressure hose to the inlet port of the In-line Muffler. Slide a new one-eared clamp onto pressure tubing.
4. Using a crimping tool or diagonals, firmly "pinch" the one-eared clamp to securely fasten the pressure tubing to the inlet port of the In-line Muffler.
5. Slide a one-eared clamp over the 1 3/4" pressure hose.
6. Align then seat the short pressure tubing on the Compressor assembly's outlet port.
7. Using a crimping tool or diagonals, firmly "pinch" the one-eared clamp to secure the connections at the Compressor assembly.



## HRUR METER REPLACEMENT

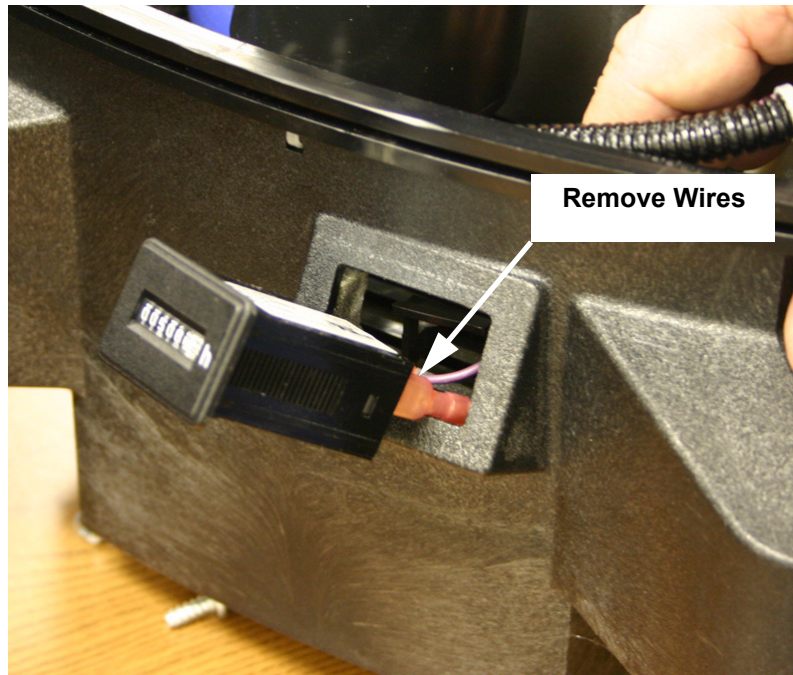
### To remove the Hour Meter

1. Remove the Rear Cabinet. Refer to the Rear Cabinet Replacement Section.
2. Slide the Front Cabinet forward until it is clear from the Base Cabinet.
3. Remove the Compressor Cover. Refer to the Compressor Cover Replacement Section.
4. Using your fingers or needle-nose pliers, remove the wires from the terminals on the back of the Hour Meter.

**NOTE**

*The Hour Meter wires are interchangeable.*

5. Spread the tabs on the locking frame out from the Hour Meter.
6. While holding the tabs spread away from the Hour Meter, push it through the openings in the Base Cabinet.



**FIGURE AJ: REMOVAL OF THE HOUR METER**

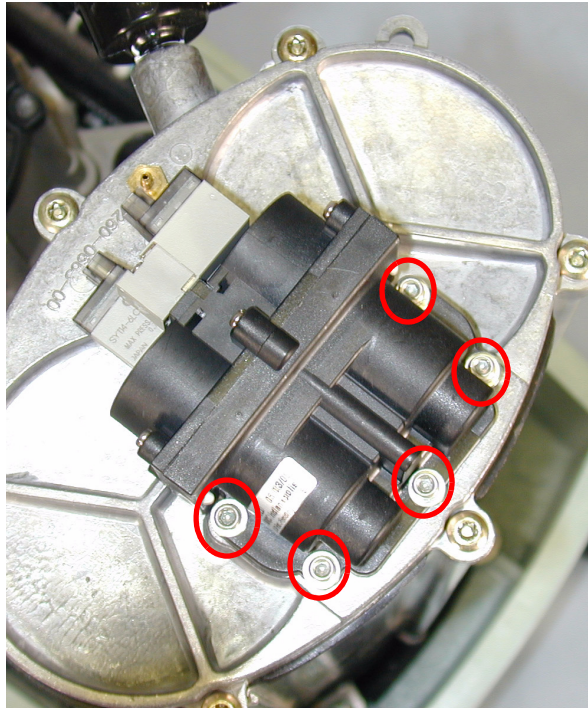
### To install the Hour Meter

1. Align then insert the Hour Meter into its receptacle in the Base Cabinet.
2. While holding the Hour Meter in place, install the locking frame over the Hour Meter from inside of the Base Cabinet. Press it onto the Hour Meter until it “snaps” in place.
3. Install the Hour Meter wires on the terminals on the back of the Hour Meter.

## VALVE/SOLENOID REPLACEMENT

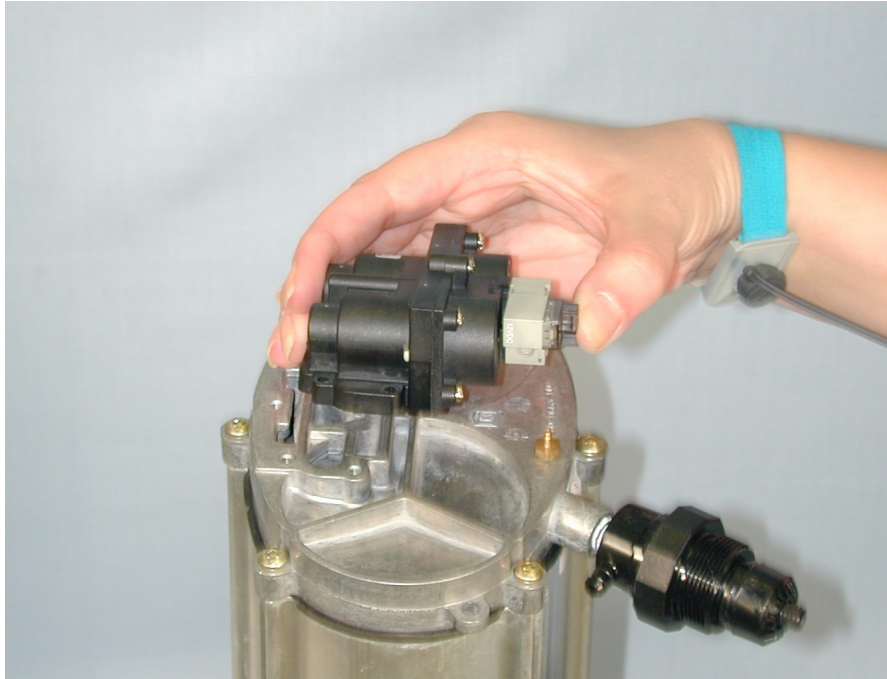
### To remove the Valve/Solenoid

1. Remove the Rear Cabinet. Refer to the Rear Cabinet Replacement Section.
2. Slide the Front Cabinet forward until it is clear from the Base Cabinet.
3. Remove the two wire connectors from the Valve/Solenoid Assembly.
4. Using a 7/64" hex key wrench or socket, remove the five screws and flat washers securing the Valve/Solenoid to the top of the Sieve Canister Assembly.



**FIGURE AK: LOCATION OF THE SCREWS SECURING THE VALVE/SOLENOID ASSEMBLY**

5. Lift the Valve/Solenoid Assembly up and away from the Sieve Canister Assembly.



**FIGURE AL: REMOVAL OF THE VALVE/SOLENOID ASSEMBLY**

**To install the Valve/Solenoid Assembly**

1. Align the Valve/Solenoid Assembly with the holes in the top of the Sieve Canister Assembly.
2. Using the five screws and flat washers provided, secure the Valve/Solenoid Assembly to the Sieve Canister Assembly. The screws should be torqued sufficiently in order to prevent leaks, but care should be taken not to crush the shoulder of the valve.
3. Reconnect the two wire connectors to the Valve/Solenoid Assembly.
4. Connect the unit to a power source and turn on the device. Apply snoop leak detector to the area where the Valve/Solenoid Assembly mounts to the Sieve Canister Assembly and check for leaks.

## PRESSURE REGULATOR REPLACEMENT

### To remove the Pressure Regulator

1. Remove the Rear Cabinet. Refer to the Rear Cabinet Replacement Section.
2. Slide the Front Cabinet forward until it is clear from the Base Cabinet.
3. Remove the pressure tubing from the outlet port on the pressure regulator.
4. Note the orientation of the pressure regulator outlet port. The new pressure regulator must be installed with the outlet port in the same position.
5. Using a pair of channel locks, remove the pressure regulator from the Sieve Canister Assembly.



**FIGURE AM: REMOVAL OF THE PRESSURE REGULATOR**

### To install the Pressure Regulator

1. Apply a layer of Teflon thread tape to the threads of the pressure regulator.

#### CAUTION

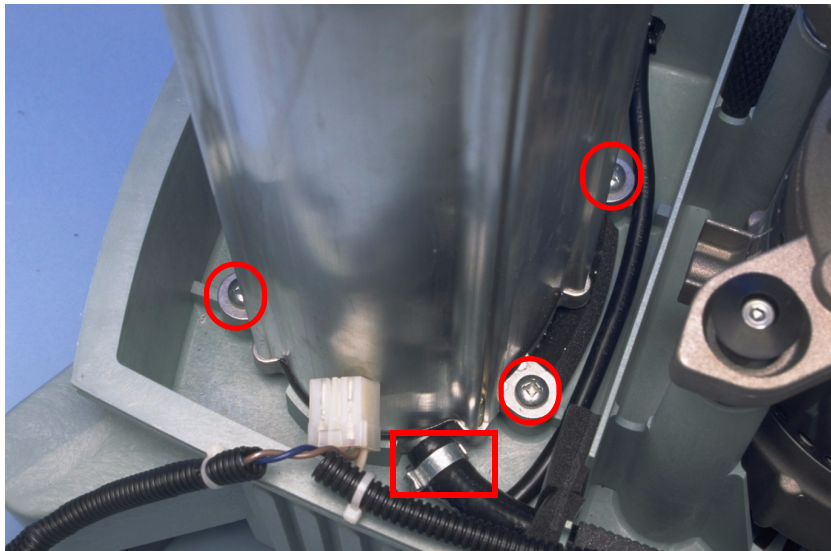
*The tape should be installed in a counter clockwise direction, with the Pressure Regulator threads facing you.*

2. Align the pressure regulator with the pressure regulator port in the Sieve Canister Assembly. Screw the pressure regulator into the Sieve Canister Assembly until strong resistance is felt and the pressure regulator outlet port is oriented in the correct position.
3. Install the pressure tubing on the pressure regulator outlet port.
4. Connect the unit to a power source and turn on the unit. Apply a snoop leak detector to the area where the pressure regulator mounts to the Sieve Canister Assembly and where the O<sub>2</sub> tubing connects to the outlet barb to check for leaks.

## SIEVE CANISTER ASSEMBLY REPLACEMENT

### To remove the Sieve Canister Assembly

1. Remove the Rear Cabinet. Refer to the Rear Cabinet Replacement Section.
2. Slide the Front Cabinet forward until it is clear from the Base Cabinet.
3. Remove the Compressor Cover. Refer to the Compressor Cover Replacement Section.
4. Remove the Valve/Solenoid Assembly. Refer to the Valve/Solenoid Replacement Section.
5. Remove the pressure regulator. Refer to the Pressure Regulator Replacement Section.
6. Using the 5/16" Nut Driver (Supplied in RI p/n H647, Millennium Tool Kit), remove the four screws securing the Sieve Canister Assembly to the Base Cabinet.
7. Using a crimping clamp tool or diagonals, cut the one-eared clamp securing the 12" pressure tubing to the inlet port of the Sieve Canister.
8. Remove the 12" pressure tubing from the inlet port of the Sieve Canister.



**FIGURE AN: LOCATION OF THE ONE-EARED CLAMP AND MOUNTING SCREWS (3 OF 4 SHOWN)**

9. Lift the Sieve Canister Assembly up and out of the Base Cabinet.
10. Remove the Blow Down Muffler from the Sieve Canister Assembly (refer to the Blow Down Muffler Replacement procedures).
11. Remove the brass fitting from the top of the Sieve Canister Assembly.

### To install the Sieve Canister Assembly

1. Install the supplied canister gasket on the bottom of the Sieve Canister Assembly.
2. Install the brass fitting in the top of the Sieve Canister Assembly.
3. Install the Blow Down Muffler onto the Sieve Canister Assembly. Refer to the Blow Down Muffler Replacement Section.

4. Set the Sieve Canister Assembly in place in the Base Cabinet.

**NOTE**

*Ensure that the AC Power Cord is clear of the Sieve Canister Assembly.*

5. Slide the one-eared clamp provided onto the 12" pressure tubing.
6. Install the 12" pressure tubing provided on the inlet port of the Sieve Canister.
7. Using a crimping clamp tool or diagonals, "pinch" the one-eared clamp securing the pressure tubing to the inlet port of the Sieve Canister Assembly.
8. Using the 5/16" Nut Driver, insert then tighten the four screws that secure the Sieve Canister Assembly to the molded base.
9. Install the pressure regulator. Refer to the Pressure Regulator Replacement Section.
10. Install the Valve/Solenoid on the top of the Sieve Canister. Refer to the Valve/Solenoid Replacement Section.
11. Install the wire connectors on the terminals of the valve/solenoid.
12. Connect the yellow pressure tubing to the brass fitting on the top of the Sieve Canister.
13. Connect the clear pressure tubing to the port on the pressure regulator.
14. Install the Compressor Cover. Refer to the Compressor Cover Replacement Section.

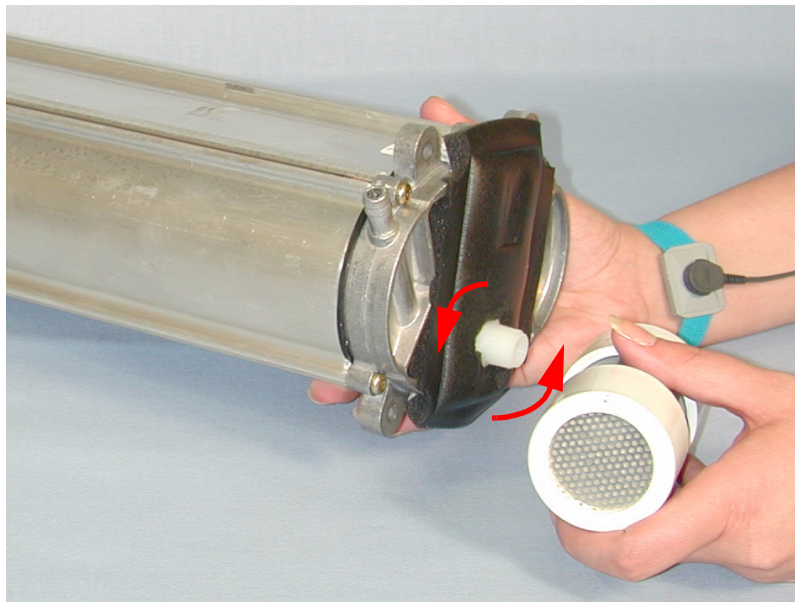
## BLOW DOWN MUFFLER REPLACEMENT

### NOTE

*If care is taken during the following procedures, the Valve/Solenoid Assembly and the pressure regulator do not have to be removed. However, if these components are damaged during the procedure, they must be replaced.*

#### To remove the Blow Down Muffler

1. Remove the Rear Cabinet. Refer to the Rear Cabinet Replacement Section.
2. Slide the Front Cabinet forward until it is clear from the Base Cabinet.
3. Remove the Compressor Cover. Refer to the Compressor Cover Replacement Section.
4. Remove the Valve/Solenoid Assembly. Refer to the Valve/Solenoid Replacement Section.
5. Remove the pressure regulator. Refer to the Pressure Regulator Replacement Section.
6. Note the orientation of the blown down muffler in relation to the Sieve Canister Assembly.
7. Using channel locks, turn the Blow Down Muffler counter-clockwise until it is free of the sieve canister assembly.



**FIGURE AO: REMOVING THE BLOW DOWN MUFFLER**

**To install the Blow Down Muffler**

1. Align the Blow Down Muffler with the Sieve Canister Assembly's threaded fitting. Screw the Blow Down Muffler onto the fitting until it comes in contact with the Sieve Canister foam and the Blow Down Muffler is positioned in its original orientation.
2. Set the Sieve Canister Assembly in place in the Base Cabinet.

**NOTE**

*Ensure that the AC Power Cord is clear of the Sieve Canister Assembly.*

3. Slide the one-eared clamp provided onto the 12" pressure tubing.
4. Install the 12" pressure tubing provided on the inlet port of the Sieve Canister.
5. Using a crimping clamp tool or diagonals, "pinch" the one-eared clamp securing the pressure tubing to the inlet port of the Sieve Canister Assembly.
6. Using the 5/16" Nut Driver, insert then tighten the four screws that secure the Sieve Canister Assembly to the molded base.
7. Install the Valve/Solenoid on the top of the Sieve Canister.
8. Install the wire connectors on the terminals of the valve/solenoid.
9. Connect the yellow pressure tubing to the brass fitting on the top of the Sieve Canister.
10. Connect the clear pressure tubing to the port on the pressure regulator.
11. Install the pressure regulator (if removed). Refer to the Pressure Regulator Replacement Section.
12. Install the Valve/Solenoid Assembly (if removed). Refer to the Valve/Solenoid Replacement Section.
13. Install the Compressor Cover. Refer to the Compressor Cover Replacement Section.



## **POWER CORD REPLACEMENT**

### **To remove the Power Cord**

1. Remove the Rear Cabinet. Refer to the Rear Cabinet Replacement Section.
2. Slide the Front Cabinet forward until it is clear from the Base Cabinet.
3. Remove the Compressor Cover. Refer to the Compressor Cover Replacement Section.
4. Disconnect the main power wiring harness connector from its receptacle on the Power Switch wiring harness. Note the orientation of both the black and white Power Cord wires in the main power wiring harness connector.
5. Using an Amp terminal retractor tool, remove the female connectors of both the black and white Power Cord wires from the main power wiring harness connector.



***FIGURE AP: REMOVING THE POWER CORD WIRES FROM THE MAIN POWER WIRING HARNESS***

6. Using a Heyco tool, depress the locking tabs on the AC Power Cord strain relief grommet installed in the Base Cabinet.
7. Once the grommet is free of the Base Cabinet, remove the Power Cord.

---

**To install the Power Cord**

1. Insert the Power Cord wires into the hole in the Base Cabinet.
2. Route the Power Cord wires to the main power wiring harness connector.
3. Align the female connectors on the end of the black and white Power Cord wires with their receptacles in the main power wiring harness connector.
4. Press each Power Cord wire female connector into the main power wiring harness connector until completely sealed.

**CAUTION**

*The black and white Power Cord wires MUST be inserted in the main power wiring harness connector in their original configuration. If they are reversed, damage to the unit will occur.*

5. Align the Power Cord strain relief grommet with the cutout in the Base Cabinet. Press the grommet into the Base Cabinet until completely seated. Using an Amp terminal retractor tool, remove the female connectors of both the black and white Power Cord wires from the main power wiring harness connector.
6. Plug the main power wiring harness connector into its receptacle on the Power Switch wiring harness.
7. Install the Compressor Cover. Refer to the Compressor Cover Replacement Section.
8. Slide the Front Cabinet onto the Base Cabinet.
9. Install the Rear Cabinet. Refer to the Rear Cabinet Replacement Section.

## BASE CABINET REPLACEMENT

### NOTE

*If care is taken during the following procedures, the Valve/Solenoid Assembly and the pressure regulator do not have to be removed. However, if these components are damaged during the procedure, they must be replaced.*

#### To remove the Base Cabinet

1. Remove the Rear Cabinet. Refer to the Rear Cabinet Replacement Section.
2. Slide the Front Cabinet forward until it is clear from the Base Cabinet.
3. Remove Compressor Cover/Perforated Canopy. Refer to the Compressor Cover Replacement Section.
4. Remove the Capacitor. Refer to the Motor Start/Run Capacitor Section.
5. Remove the Compressor/motor assembly. Refer to the Compressor Assembly Replacement Section.
6. Remove the In-line Muffler. Refer to the In-line Muffler Replacement Section.
7. Remove the Hour Meter. Refer to the Hour Meter Replacement Section.
8. Remove the Sieve Canister Assembly. Refer to the Sieve Canister Assembly Replacement Section.
9. Remove the Power Cord. Refer to the Power Cord Replacement Section.
10. Remove the Base Cabinet and bottom pan.

#### To install the Base Cabinet

1. All components have now been removed from the original Base Cabinet. To begin reassembly, place the Base Cabinet on a protected work surface. Follow the disassembly process in reverse order to reassemble the unit.

## M10600/M10605 CONCENTRATOR REPAIR & REPLACEMENT

### SECTION OVERVIEW

This chapter illustrates the repair and replacement procedures for the components of the Millennium M10600/M10605 Oxygen Concentrators. Once repair is complete refer to the testing section for proper testing procedures.

#### WARNINGS

- *To prevent electrical shock, disconnect the electrical supply before attempting to make any device repairs to the Millennium Oxygen Concentrators.*
- *Use extreme caution when handling the Compressor/motor assembly Capacitor. The Capacitor can hold a substantial electrical charge until it is properly discharged.*
- *Avoid handling the molecular sieve material. Respironics recommends the return of the Sieve Canister Assembly to Respironics for any service that involves sieve material disposal.*
- *Even with the unit disconnected from the electrical supply, the Capacitor may still hold an electrical charge strong enough to cause serious bodily injury. DO NOT touch the Capacitor terminals simultaneously until the Capacitor has been completely discharged. Discharge the Capacitor by shorting the two posts with an insulated screw driver.*

#### CAUTION

- *Electronic components used in this unit are subject to damage from static electricity. Repairs made to this unit must be performed only in an antistatic, ESD-protected environment.*
- *During all repair and replacement procedures, assure that any connections that are broken during the process (fittings, tubing, and hoses) are reconnected securely.*
- *When using leak detector, be careful that it does not come in contact with any electrical components.*
- *The fuse on the power control board must be replaced with a fuse of the same rating as the original. Failure to do so will result in damage to the unit.*

## OVERLAY REPLACEMENT

### To remove the Overlay

1. Starting at one corner, carefully peel the Overlay off of the cabinet.
2. Use a small amount of isopropyl alcohol applied to a cleaning cloth to remove any adhesive residue from the cabinet.

### NOTE

*When using isopropyl alcohol to clean the mounting area for the control Overlay, ensure that no liquid enters the Front Cabinet or comes into contact with the LEDs. Use protective glasses.*

### To install the Overlay

1. Remove the protective backing from the Overlay.
2. Carefully align the Overlay with the applicable mounting area. Set the Overlay in place and, using a circular motion, firmly rub the Overlay until it is securely attached to the cabinet.



**FIGURE A: PROPER INSTALLATION OF FRONT CABINET OVERLAY**

## CASTER REPLACEMENT

### To remove the Casters

1. Place the unit on a protected work surface and carefully lay the unit over its Rear Cabinet.



**FIGURE B: LOCATION OF CASTERS**

2. While holding the unit firmly in place, grasp the Caster to be replaced and pull it firmly out of its receptacle in the molded base.

### NOTE

*It may be necessary to insert a medium flat-blade screwdriver between the Caster and the molded base to “pry” the Caster from its receptacle. Once the Caster has been partially removed, a rubber mallet can be used to completely remove the Caster from its receptacle. If this is necessary, care should be taken to prevent damage to the molded case.*

3. If more than one Caster is to be replaced, repeat the procedure for each Caster to be replaced.

### To install the Casters

1. Align the Caster shaft with its receptacle in the molded base.
2. While holding the unit in place, firmly push the Caster into its receptacle until completely seated.

### NOTE

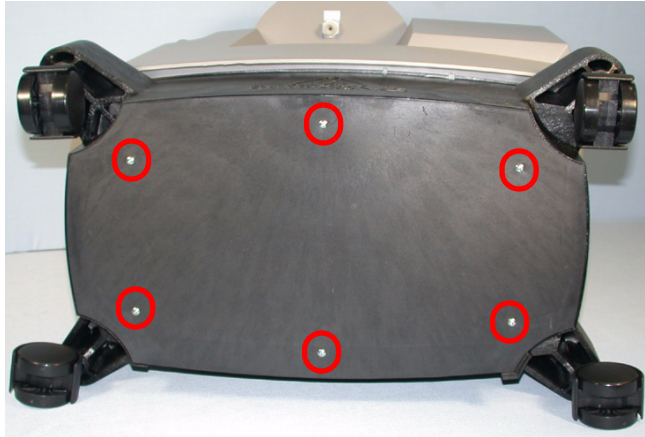
*It may be necessary to use a rubber mallet to gently tap the Caster into the molded base. If this is necessary, care should be taken to prevent damage to the molded case. In some cases, use water to lubricate the post.*

3. If more than one Caster is being replaced, repeat the procedure for each Caster being replaced.
4. Carefully return the unit to the upright position.

## BASE CABINET PAN REPLACEMENT

### To remove the Base Cabinet Pan

1. Place the unit on a protected work surface and carefully lay the unit over its Rear Cabinet.
2. Remove the six Phillips screws securing the Base Cabinet Pan to the Base Cabinet.

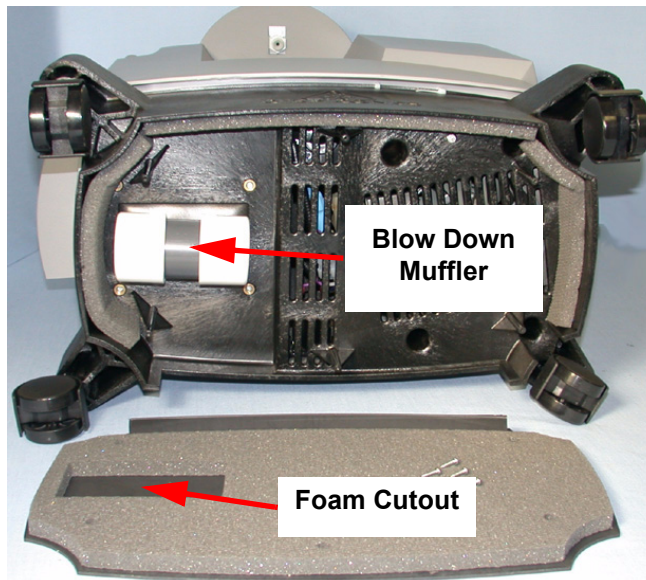


**FIGURE C: SCREW LOCATIONS**

3. Grasp the back edge of the Base Cabinet Pan and remove it from the Base Cabinet.

### To install the Base Cabinet Pan

1. Position the Base Cabinet Pan so the cut-out in the foam insulation aligns with the Blow Down Muffler.



**FIGURE D: LOCATION OF BLOW DOWN MUFFLER AND FOAM CUTOUT**

2. Align the Base Cabinet Pan with the Base Cabinet and set it into place.
3. Insert and gently tighten the six Phillips screws provided to secure the Base Cabinet Pan to the Base Cabinet.

## REAR CABINET REPLACEMENT

### To remove the Rear Cabinet

1. Using a Phillips screwdriver, remove the six screws that secure the Rear Cabinet to the Front Cabinet.



**FIGURE E: SCREW LOCATIONS**

2. Grasp the Rear Cabinet firmly then slide it toward the back of the unit until it is clear of the guide slot on the Base Cabinet. Once clear of the guide slot, the Rear Cabinet can be lifted away from the unit.

### To install the Rear Cabinet

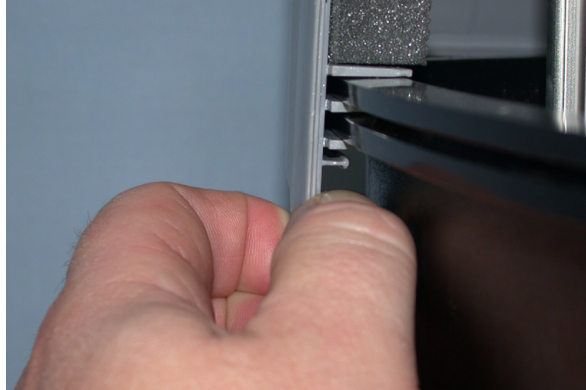
#### **NOTE**

*The Base Cabinet has a guide slot to ensure proper alignment of the rear and Front Cabinets. The rear and Front Cabinets MUST be properly aligned with the guide slot to ensure correct installation.*

1. Align the ridges on the Rear Cabinet with the guide slot in the Base Cabinet.



2. Once the guide slot and ridges are correctly aligned, hold the Front Cabinet in place while sliding the Rear Cabinet onto the Base Cabinet.



***FIGURE F: ALIGNMENT OF GUIDE SLOT AND RIDGES***

3. Using a Phillips screwdriver, install and secure the six mounting screws securing the Rear Cabinet to the Front Cabinet.

## FLOW METER REPLACEMENT

### To remove the Flow Meter

1. Remove the Rear Cabinet. Refer to the Rear Cabinet Replacement Section.
2. Slide the Front Cabinet forward until it is clear from the Base Cabinet.
3. Working from inside the Front Cabinet, cut the cable ties then remove the pressure tubing from both fittings on the Flow Meter by pulling the tubing from each fitting.



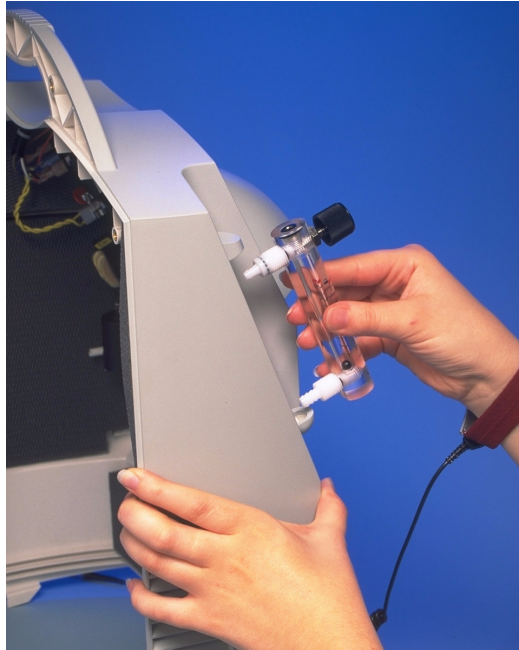
**FIGURE G: REMOVE THE PRESSURE TUBING FROM THE FLOW METER**

### NOTE

*The pressure tubing connected to the top fitting on the Flow Meter is connected to the bacteria filter. The pressure tubing connected to the bottom fitting is connected to the OPI sensor for Model M10605, or the 1/2" tubing in the wiring harness for Model M10600.*

4. While holding the Flow Meter in place, remove the two speed nuts from the threaded fittings on the back of the Flow Meter.

5. Remove the Flow Meter from the Front Cabinet assembly by pulling it straight out from the Front Cabinet.



**FIGURE H: REMOVING THE FLOW METER**

#### To install the Flow Meter

1. Align the threaded fittings on the back of the supplied Flow Meter with the holes in the Front Cabinet.

#### **NOTE**

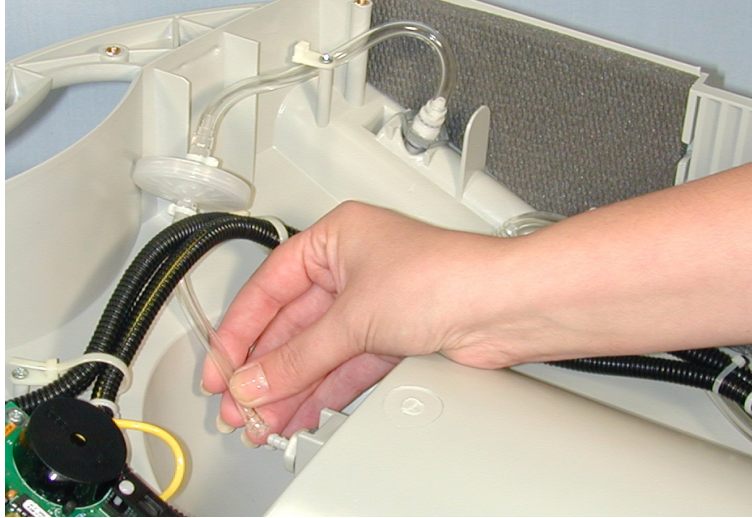
*The Flow Meter must be mounted with the shaft for the Flow Meter knob at the top.*

2. While holding the Flow Meter in place, install the support speed nuts to secure the Flow Meter to the Front Cabinet. Hand tighten the speed nuts.
3. Connect the pressure tubing to the fittings on the Flow Meter then secure the tubing with the cable ties provided.
4. Turn on the unit and check the flow tube connections for leaks.
5. If no leaks are detected, Turn off the unit and reassemble and test unit.

## DISS OUTLET FITTING REPLACEMENT

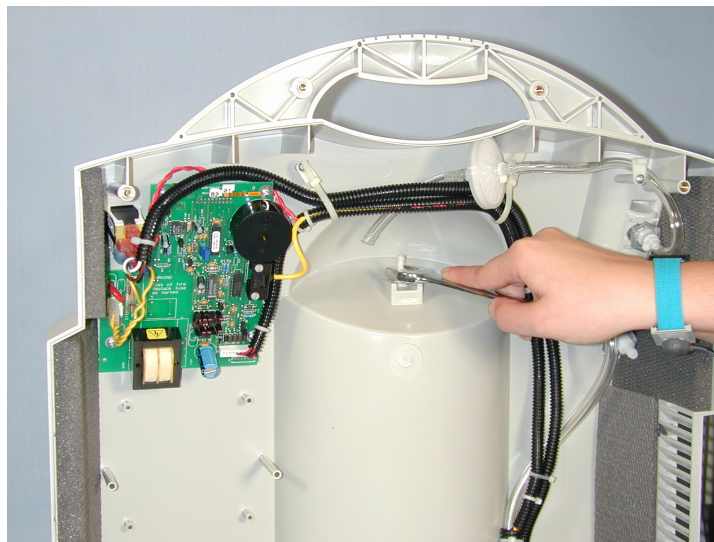
### To remove the DISS Outlet Fitting

1. Remove the Rear Cabinet. Refer to the Rear Cabinet Replacement Section.
2. Slide the Front Cabinet forward until it is clear from the Base Cabinet.
3. Cut the cable tie then remove the pressure tubing connected to the DISS outlet fitting by pulling it off the fitting.



**FIGURE I: REMOVE TUBING FROM DISS FITTING**

4. While holding the DISS outlet fitting in place, use an 11/16" wrench to loosen the nylon jam nut securing the DISS outlet fitting.



**FIGURE J: REMOVE JAM NUT**

5. Remove the DISS outlet fitting from the Front Cabinet.



**FIGURE K: REMOVAL OF THE DISS FITTING**

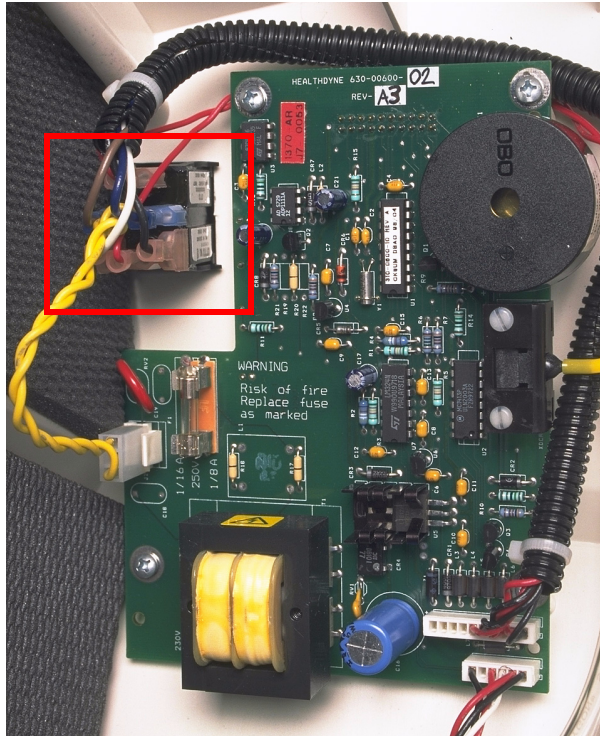
**To install the DISS Outlet Fitting**

1. Align the DISS outlet fitting with the opening in the Front Cabinet. Insert the DISS outlet fitting into the opening.
2. While holding the DISS outlet fitting in place, install the new lock washer and nylon jam nut on the DISS outlet fitting. Use an 11/16" wrench to carefully tighten the nylon jam nut.
3. Connect the pressure tubing to the fittings on the DISS outlet fitting. Secure the tubing to the fitting with the cable tie provided.

## POWER SWITCH REPLACEMENT

### To remove the Power Switch

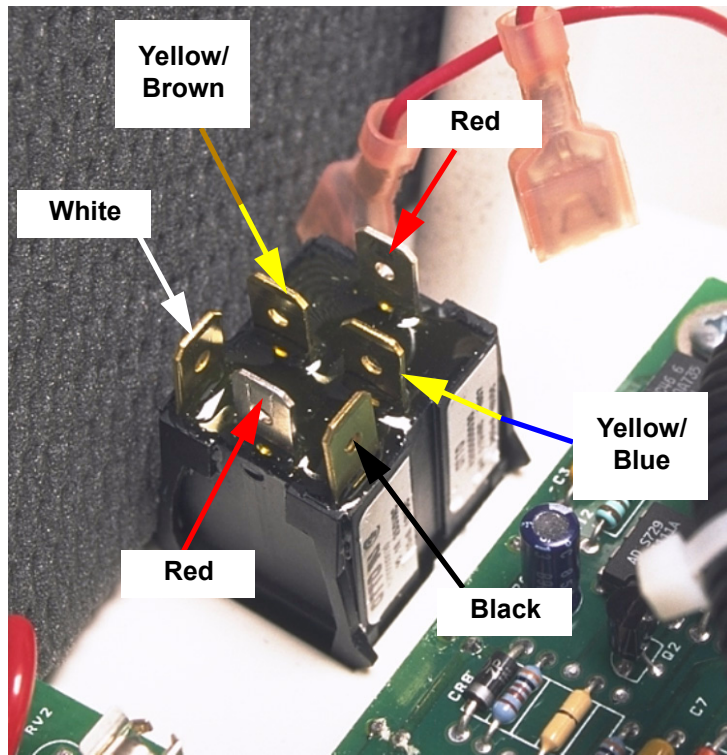
1. Remove the Rear Cabinet. Refer to the Rear Cabinet Replacement Section.
2. Slide the Front Cabinet forward until it is clear from the Base Cabinet.
3. Looking at the back of the Power Switch from inside the Front Cabinet, note the position and colors of the wires connected to the terminals on the Power Switch.



**FIGURE L: VIEW OF POWER SWITCH FROM INSIDE THE FRONT CABINET ASSEMBLY**

### CAUTION

*Except for the two red wires that are interchangeable, the wires must be connected to the Power Switch as shown. Failure to do so will result in damage to the unit.*



**FIGURE M: CORRECT CONNECTION OF THE WIRES TO THE POWER SWITCH**

4. Using needle nose pliers, remove the wires from the Power Switch terminals. Using your fingers or a small flat-blade screwdriver, depress the latches on each corner of the Power Switch.
5. While depressing the latches, push the Power Switch out of the Front Cabinet assembly.



**FIGURE N: REMOVING THE POWER SWITCH FROM THE FRONT CABINET ASSEMBLY**

**To install the Power Switch**

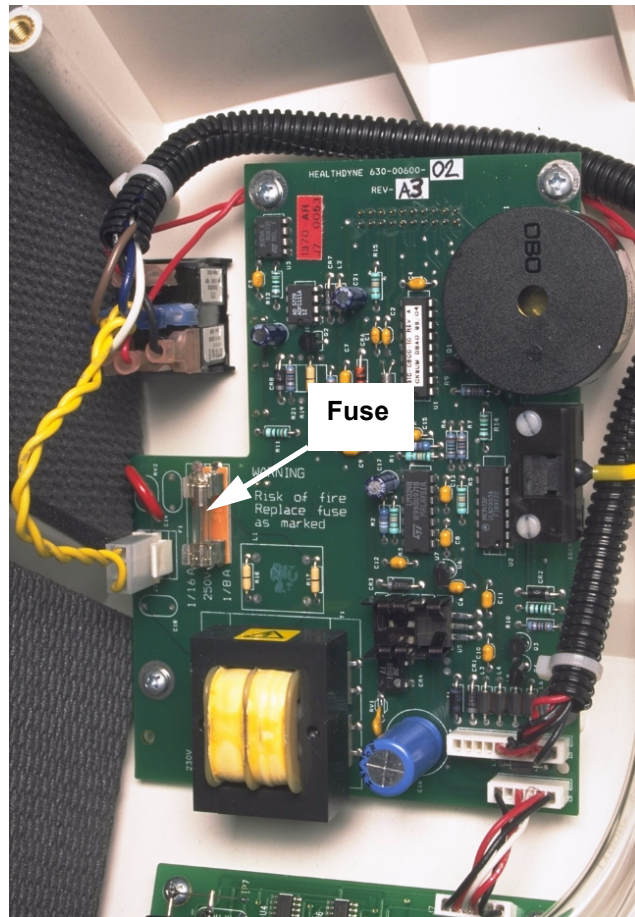
1. Orient the Power Switch so that the single terminal is at the top. Align the Power Switch with the opening in the Front Cabinet assembly. Press the Power Switch into the Front Cabinet assembly until all four latches on the Power Switch lock in place.
2. Install the wires onto the terminals of the Power Switch. Ensure that they are installed in their original position.



## MAIN PCB FUSE REPLACEMENT

### To remove the Main PCB Fuse

1. Remove the Rear Cabinet. Refer to the Rear Cabinet Replacement Section.
2. Slide the Front Cabinet forward until it is clear from the Base Cabinet.
3. Using a fuse extractor, remove the fuse from its receptacle on the Main PCB.



**FIGURE O: FUSE LOCATION**

### To install the Main PCB Fuse

1. Align the fuse with its receptacle on the Main PCB.
2. Carefully press the fuse into its receptacle until completely seated.

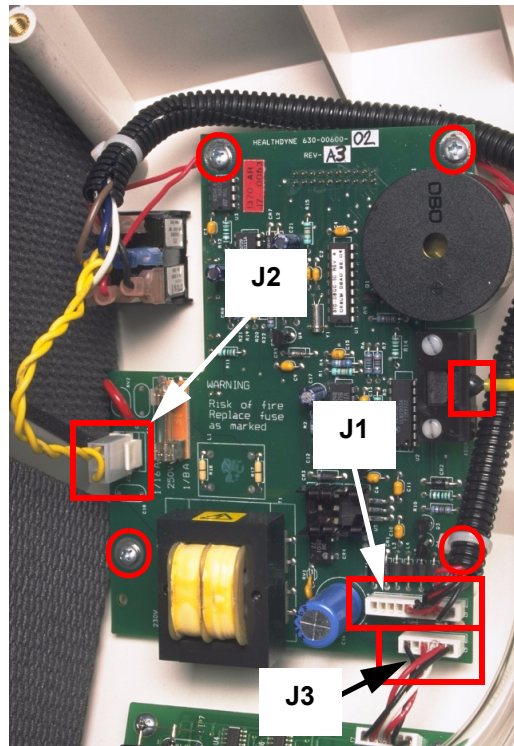
## MAIN PCB REPLACEMENT

### CAUTION

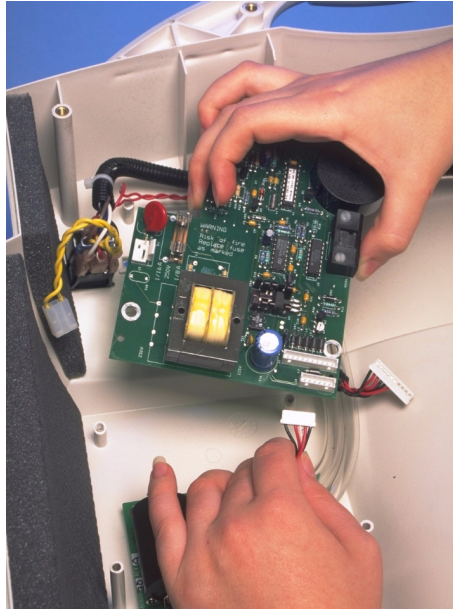
*Electronic components used in this unit are subject to damage from static electricity. Repairs made to this unit must be performed only in an antistatic, ESD-protected environment.*

#### To remove the Main PCB

1. Remove the Rear Cabinet. Refer to the Rear Cabinet Replacement Section.
2. Slide the Front Cabinet forward until it is clear from the Base Cabinet.
3. While holding the pressure transducer, remove the thin yellow pressure tubing from the pressure transducer by carefully pulling the tubing off the fitting.
4. Remove the main power Wiring harness connector from the J1 location on the Main PCB assembly by pulling the connector directly up from the J1 receptacle.
5. **For M10605 Only:** Remove the OPI wiring harness connector from the J3 location on the Main PCB assembly by pulling the connector directly up from the J3 receptacle.
6. Depress the locking tab, then remove the Power Switch wiring harness connector from the J2 location on the Main PCB by pulling the connector directly up from the J2 receptacle.
7. Using a Phillips screwdriver, remove the four screws securing the Main PCB assembly to the Front Cabinet. While holding the wiring harness out of the way, remove the Main PCB assembly from the Front Cabinet assembly.



**FIGURE P: CONNECTIONS AND SCREW LOCATIONS ON MAIN PCB**



**FIGURE Q: REMOVING THE MAIN PCB**

## To install the Main PCB

1. While holding the wiring harnesses out of the way, align the holes in the Main PCB assembly with the standoffs on the Front Cabinet assembly.
2. Insert then tighten the four screws provided to secure the Main PCB assembly to the Front Cabinet assembly.
3. Align the connector on the Power Switch wiring harness with the J2 receptacle on the Main PCB assembly. Carefully press the connector onto the receptacle until completely seated.
4. **For M10605 Only:** Align the connector on the short OPI wiring harness with the J3 receptacle on the Main PCB assembly. Carefully press the connector onto the receptacle until completely seated.
5. Align the connector on the main power wiring harness with the J1 receptacle on the Main PCB assembly. Carefully press the connector onto the receptacle until completely seated.
6. While holding the pressure transducer, install the thin yellow pressure tubing onto the pressure transducer by firmly and carefully pushing the tubing onto the fitting.

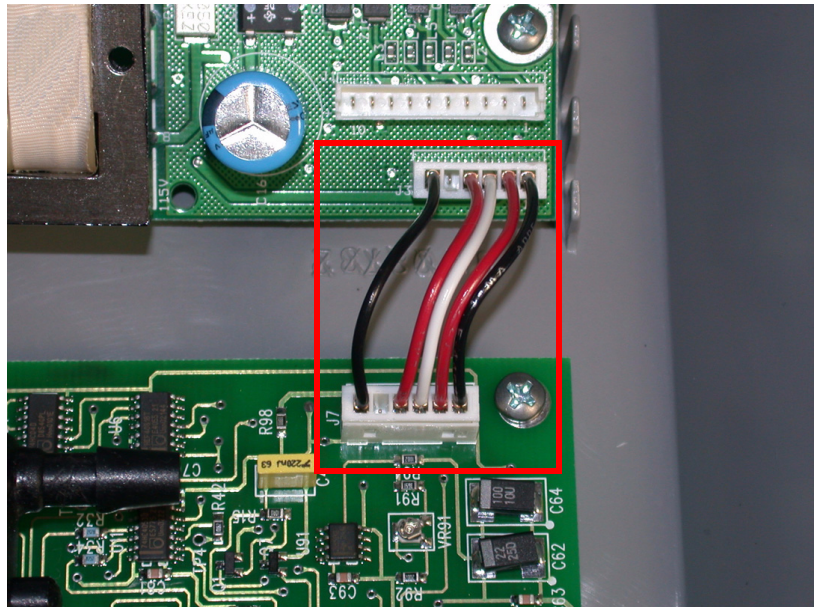
## OPI WIRING HARNESS REPLACEMENT (MODEL M10605 ONLY)

### CAUTION

*Electronic components used in this unit are subject to damage from static electricity. Repairs made to this unit must be performed only in an antistatic, ESD-protected environment.*

#### To remove the OPI Wiring Harness

1. Remove the Rear Cabinet. Refer to the Rear Cabinet Replacement Section.
2. Slide the Front Cabinet forward until it is clear from the Base Cabinet.
3. Remove the OPI wiring harness connector from the J3 location on the Main PCB assembly by pulling the connector directly up from the J3 receptacle.
4. Remove the OPI wiring harness connector from the J7 location on the OPI board by pulling the connector directly up from the J7 receptacle.



**FIGURE R: OPI WIRING HARNESS**

#### To install the OPI Wiring Harness

1. Align the connector on the OPI board wiring harness with the J7 receptacle on the OPI board. Carefully press the connector onto the receptacle until completely seated.
2. Align the connector on the OPI wiring harness with the J3 receptacle on the Main PCB assembly. Carefully press the connector onto the receptacle until completely seated.

## OPI BOARD REPLACEMENT (MODEL M10605 ONLY)

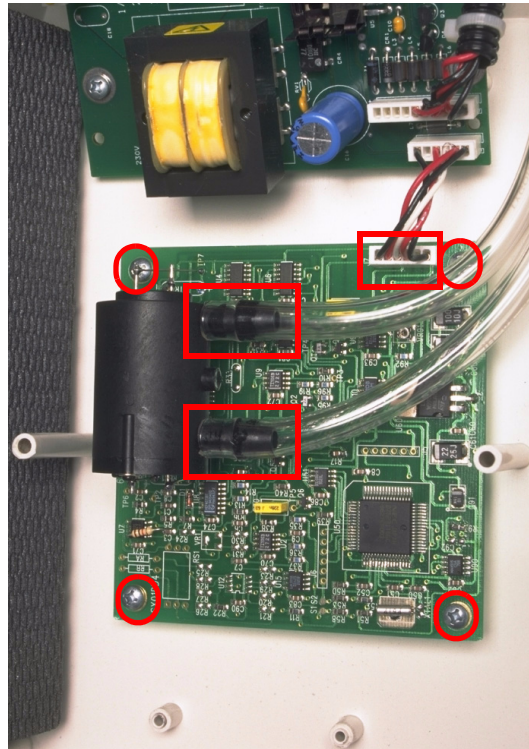
### To remove the OPI Board

1. Remove the Rear Cabinet. Refer to the Rear Cabinet Replacement Section.
2. Slide the Front Cabinet forward until it is clear from the Base Cabinet.
3. Remove the OPI wiring harness connector from the J7 location on the OPI board by pulling the connector directly up from the J7 receptacle.
4. While holding the oxygen sensor, remove the pressure tubing from the sensor by carefully prying the tubing off both oxygen sensor fittings.

### NOTE

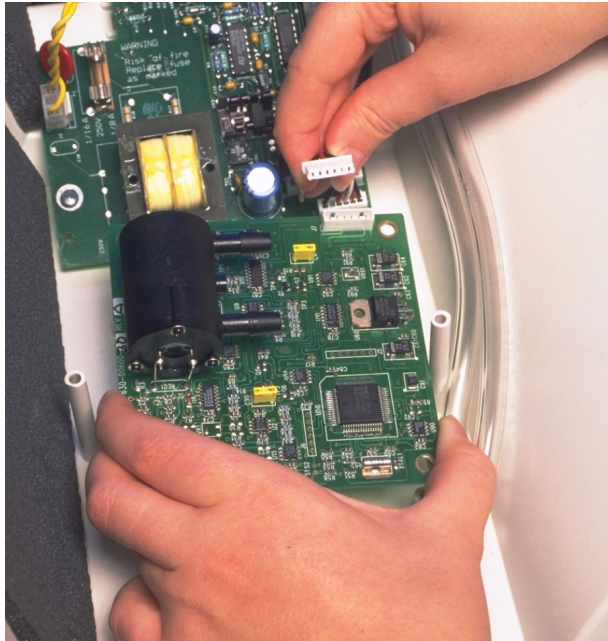
*The pressure tubing from the Flow Meter is connected to the top fitting on the oxygen sensor. The pressure tubing connected to the pressure regulator on the Sieve Canister Assembly is connected to the bottom fitting on the oxygen sensor.*

5. Using a Phillips screwdriver, remove the four screws securing the OPI board to the Front Cabinet.



**FIGURE S: CONNECTIONS AND SCREW LOCATIONS ON OPI BOARD**

6. While holding the wiring harness out of the way, remove the OPI board from the Front Cabinet.



**FIGURE T: REMOVING THE OPI BOARD**

#### **To install the OPI Board**

1. Align the holes in the OPI board with the standoffs on the Front Cabinet.
2. Insert then tighten the four screws provided to secure the OPI board to the Front Cabinet.
3. While holding the oxygen sensor, install the pressure tubing on the oxygen sensor by carefully pushing the tubing onto the oxygen sensor fittings.
4. Align the connector on the OPI wiring harness with the J7 receptacle on the OPI board. carefully press the connector onto the receptacle until completely seated.

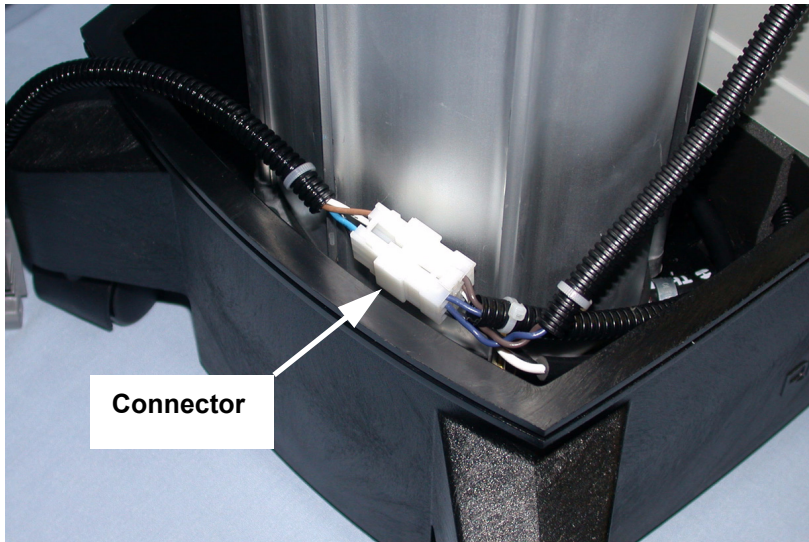
#### **NOTE**

*Once the unit is reassembled, verify that there are no O<sub>2</sub> leaks. Set the Flow Meter to 0 lpm. Ensure the “no flow” alert activates. The alert should activate. If not, check for leaks at newly installed OPI board.*

## POWER SWITCH WIRING HARNESS REPLACEMENT

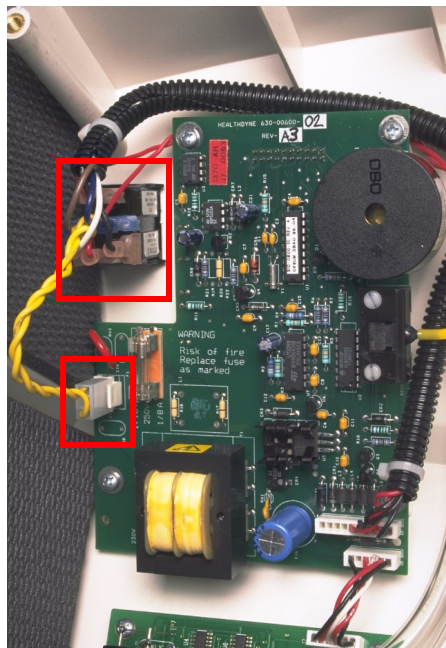
### To remove the Power Switch Wiring Harness

1. Remove the Rear Cabinet. Refer to the Rear Cabinet Replacement Section.
2. Slide the Front Cabinet forward until it is clear from the Base Cabinet.
3. Disconnect the male connector on the Power Switch wiring harness from this female connector on the main power wiring harness.



**FIGURE U: LOCATION OF THE CONNECTOR**

4. Remove the female connector from the (J2) location on the power control board (Main PCB).



**FIGURE V: MAIN PCB (J2) AND POWER SWITCH LOCATION**

- Looking at the back of the Power Switch from inside the Front Cabinet, note the position and colors of the wires connected to the terminals on the Power Switch.

## CAUTION

*Except for the two red wires that are interchangeable, the wires must be connected to the Power Switch as shown. Failure to do so will result in damage to the unit.*

- Using needle nose pliers, remove the connectors from the Power Switch terminals.

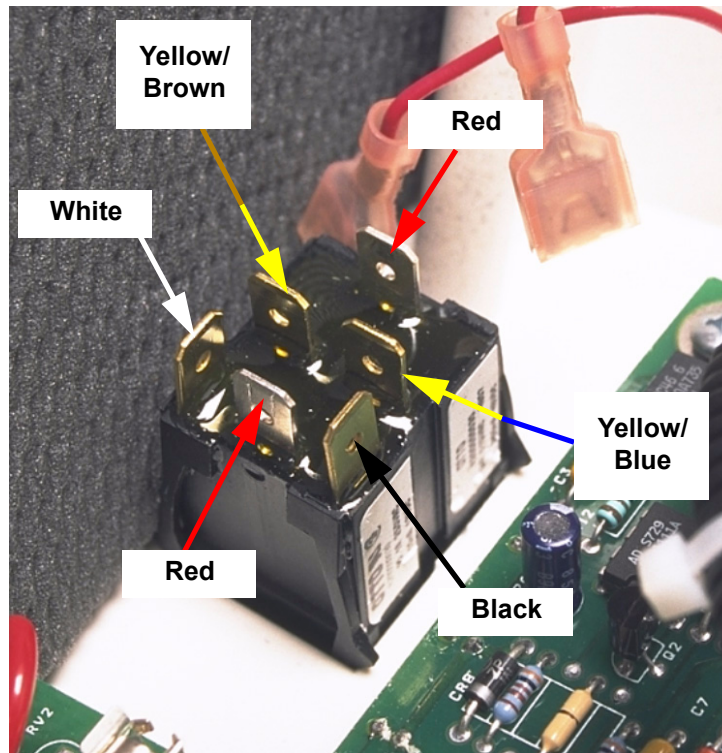
## NOTE

*The two red wires from the O<sub>2</sub>/solenoid/battery wiring harness do not have to be disconnected from the Power Switch.*

- Remove the screws that secure the screw down cables ties to the Front Cabinet.
- Either feed the Power Switch wiring harness through the screw down cable ties or, if new screw down cable ties are available, cut the cable ties and remove the Power Switch wiring harness.

### To install the Power Switch Wiring Harness

- Either feed the Power Switch wiring harness through the original screw down cable ties, or if new screw down cable ties are available, loosely install four cable ties grouping the Power Switch wiring harness, the O<sub>2</sub>/solenoid/battery wiring harness, and yellow pressure tubing together.
- Install the connectors onto the proper terminals of the Power Switch. Ensure that they are installed in their original position.



**FIGURE W: CORRECT CONNECTION OF THE WIRES TO THE POWER SWITCH**

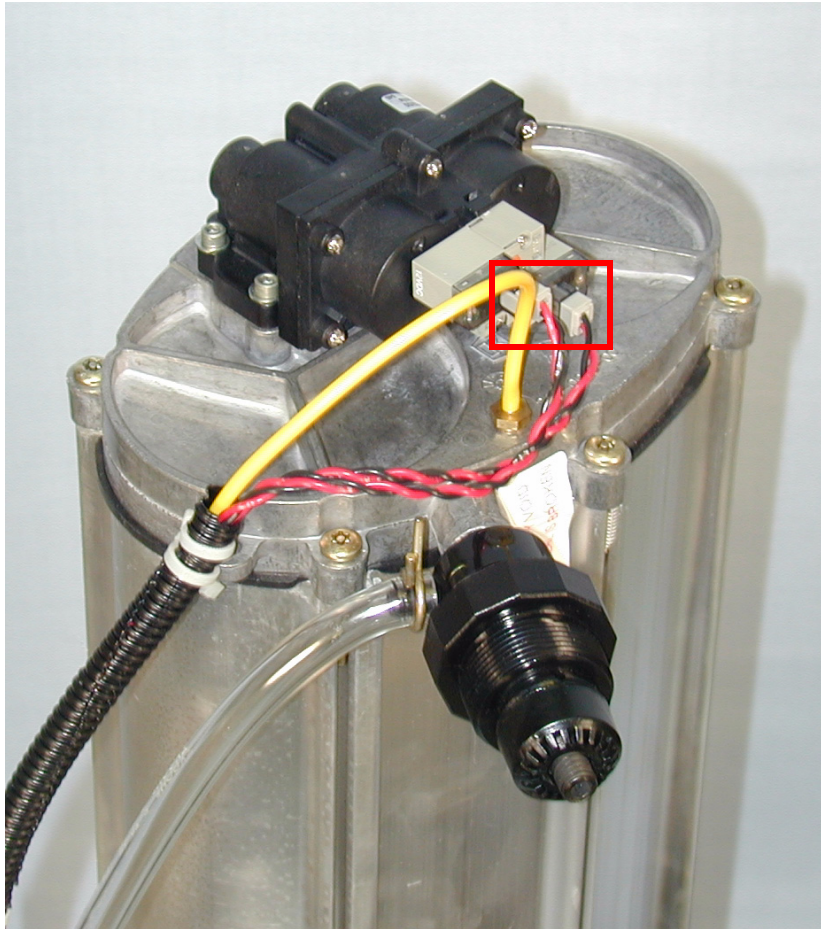


3. Install the female connector onto the (J2) location on the Main PCB.
4. Position the screw down cable ties at their mounting posts then secure each using the original screws. Tighten the screw down cable ties.
5. Connect the male connector on the Power Switch wiring harness from the female connector on the main power wiring harness.

## O<sub>2</sub>/SOLENOID/BATTERY WIRING HARNESS

### To remove the O<sub>2</sub>/Solenoid/Battery Wiring Harness

1. Remove the Rear Cabinet. Refer to the Rear Cabinet Replacement Section.
2. Slide the Front Cabinet forward until it is clear from the Base Cabinet.
3. Remove the battery connector from the battery.
4. Remove the two connectors from the Valve/Solenoid Assembly.



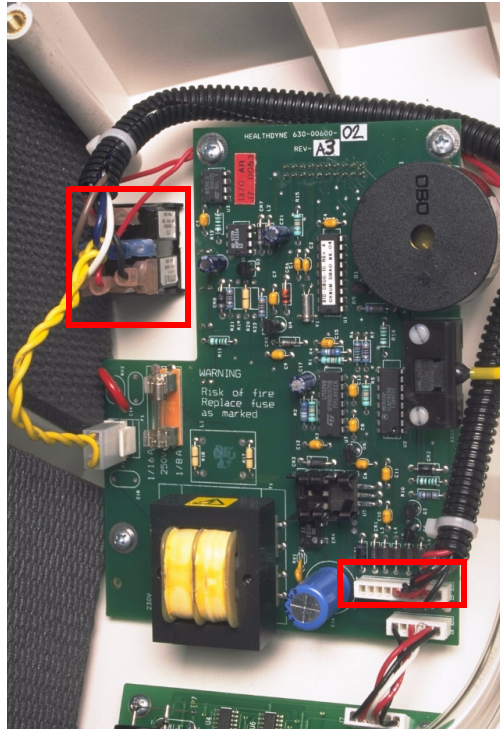
**FIGURE X: VALVE/SOLENOID CONNECTIONS**

5. Remove the two red wires connected to the Power Switch.

### NOTE

*The two red wires are interchangeable.*

6. Remove the O<sub>2</sub>/solenoid/battery wiring harness connector from the J1 location on the OPI Board.



**FIGURE Y: POWER SWITCH AND (J1) LOCATION**

7. Remove the screws that secure the screw down cable ties to the Front Cabinet.
8. Either feed the O<sub>2</sub>/solenoid/battery wiring harness through the screw down cable ties or, if new screw down cable ties are available, cut the cable ties and remove the O<sub>2</sub>/solenoid/battery wiring harness.
9. Note the location at which the battery wires exit the large convoluted tubing. Cut the cable ties and remove the O<sub>2</sub>/solenoid/battery wiring harness from the convoluted tubing.

### **To install the O<sub>2</sub>/Solenoid/Battery Wiring Harness**

1. Install the O<sub>2</sub>/solenoid/battery wiring harness into the large convoluted tubing. Ensure that the battery wires exit the large convoluted tubing at their original location. Secure the convoluted tubing with four cable ties.
2. Either feed the O<sub>2</sub>/solenoid/battery wiring harness through the original screw down cable ties, or if new screw down cable ties are available, loosely install four cable ties grouping the O<sub>2</sub>/solenoid/battery wiring harness, Power Switch wiring harness, along with the clear and yellow pressure tubing together.
3. Install the O<sub>2</sub>/solenoid/battery wiring harness connector onto the J1 location on the OPI board.
4. Install the two red wires from the O<sub>2</sub>/solenoid/battery wiring harness to the Power Switch.
5. Position the screw down cable ties at their mounting posts then secure each using the original screws. Tighten the screw down cable ties.
6. Install the two connectors from the O<sub>2</sub>/solenoid/battery wiring harness on the Valve/Solenoid Assembly.
7. Install the battery connector on the battery.

## FRONT CABINET REPLACEMENT

### To remove the Front Cabinet

1. Remove the Rear Cabinet. Refer to the Rear Cabinet Replacement Section.
2. Slide the Front Cabinet forward until it is clear from the Base Cabinet.
3. Remove the Flow Meter. Refer to the Flow Meter Replacement Section.
4. Remove the DISS outlet fitting. Refer to the DISS Outlet Fitting Replacement Section.
5. Remove the Power Switch harness. Refer to the Power Switch Wiring Harness Replacement Section.
6. Remove the O<sub>2</sub>/solenoid/battery wiring harness. Refer to the O<sub>2</sub>/Solenoid/Battery Wiring Harness Section.
7. Remove the Power Switch. Refer to the Power Switch Replacement Section.
8. Remove the OPI Wiring Harness. Refer to the OPI Wiring Harness Replacement (Model M10605 Only) Section.
9. Remove the Main PCB. Refer to the Main PCB Replacement Section.
10. Remove the OPI board. Refer to the OPI Board Replacement (Model M10605 Only) Section.

### To install the Front Cabinet

1. Remove the protective backing from the control Overlay. Carefully aligning the Overlay apply it to the Front Cabinet.
2. Position the Front Cabinet face down on a protected work surface that will not damage the Front Cabinet.
3. Install the OPI Board. Refer to the OPI Board Replacement (Model M10605 Only) Section.
4. Install the Main PCB. Refer to the Main PCB Replacement Section.
5. Install the OPI Wiring Harness. Refer to the OPI Wiring Harness Replacement (Model M10605 Only) Section.
6. Install the Power Switch. Refer to the Power Switch Replacement Section.
7. Install the O<sub>2</sub>/solenoid/battery wiring harness. Refer to the O<sub>2</sub>/Solenoid/Battery Wiring Harness Section.
8. Install the Power Switch harness. Refer to the Power Switch Wiring Harness Replacement Section.
9. Install the DISS outlet fitting. Refer to the DISS Outlet Fitting Replacement Section.
10. Install the Flow Meter. Refer to the Flow Meter Replacement Section.
11. Slide the Front Cabinet onto the Base Cabinet.
12. Install the Rear Cabinet. Refer to the Rear Cabinet Replacement Section.

## COOLING FAN REPLACEMENT

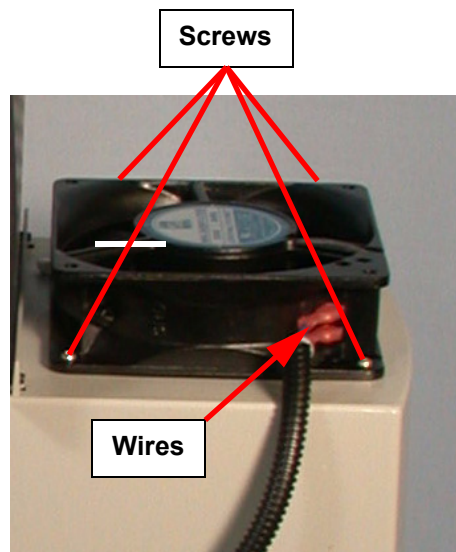
### To remove the Cooling Fan

1. Remove the Rear Cabinet. Refer to the Rear Cabinet Replacement Section.
2. Slide the Front Cabinet forward until it is clear from the Base Cabinet.
3. Remove the two wires from the terminals located on the side of the cooling fan.

**NOTE**

*The two wires are interchangeable.*

4. Using a small, thin shaft Phillips screwdriver, remove the four screws securing the cooling fan to the Compressor Cover.



**FIGURE Z: LOCATION OF COOLING FAN WIRES AND MOUNTING SCREWS**

5. While holding the Compressor Cover in place, lift the fan up and away from the Compressor Cover.

### To install the Cooling Fan

1. Align the cooling fan with the holes in the Compressor Cover.

**NOTE**

*The fan must be installed so the terminals are oriented towards the front and center of the unit.*

2. Insert then tighten the four screws to secure the fan to the Compressor Cover.

3. Connect the fan wires to the terminals on the side of the cooling fan.

## NOTE

*Ensure that the convoluted tubing covering the fan wires is still properly seated in the wire holder built into the front of the Compressor.*

## PERFORATED CANOPY REPLACEMENT

### To remove the Perforated Canopy

1. Remove the Rear Cabinet. Refer to the Rear Cabinet Replacement Section.
2. Slide the Front Cabinet forward until it is clear from the Base Cabinet.
3. Remove the 9-volt alarm battery from its holder.
4. Press inward on the bottom of each side of the Perforated Canopy until the locating posts are clear of the holes in the Compressor Cover.
5. Lift the Perforated Canopy up and away from the Compressor Cover.

### To install the Perforated Canopy

1. While exerting slight inwards pressure on the sides of the Perforated Canopy, align the locating posts with the holes in the Compressor Cover.
2. Release the pressure, then ensure that the locating posts have locked in place in the Compressor Cover.
3. Install the 9-volt battery in its holder.



**FIGURE AA: PERFORATED CANOPY**

## COMPRESSOR COVER REPLACEMENT

### To remove the Compressor Cover

1. Remove the Rear Cabinet. Refer to the Rear Cabinet Replacement Section.
2. Slide the Front Cabinet forward until it is clear from the Base Cabinet.
3. Remove the cooling fan. Refer to the Cooling Fan Replacement Section.
4. Remove the Perforated Canopy. Refer to the Perforated Canopy Replacement Section.
5. Remove the convoluted tubing containing the fan wires from the wire holder built into the front of the Compressor Cover.
6. Remove the 9-volt battery.
7. Lift the Compressor Cover housing straight up and then away from the Base Cabinet.

### To install the Compressor Cover

1. Position the Compressor Cover so the built-in wire holder is facing the front of the unit.
2. Align the round hole in the top of the Compressor Cover housing with the inlet port of the Compressor assembly.
3. Set the Compressor Cover into place on the Base Cabinet. Ensure that the bottom of the Compressor Cover housing is correctly seated on the Base Cabinet.
4. Insert the convoluted tubing containing the fan wires into the built-in wire holder on the front of the Compressor Cover.



**FIGURE AB: LOCATION OF THE COMPRESSOR COVER (SHOWN WITH FAN ATTACHED)**

## MAIN POWER WIRING HARNESS REPLACEMENT

### WARNING

*Make sure the AC power is disconnected.*

#### To remove the Main Power Wiring Harness

1. Remove the Rear Cabinet. Refer to the Rear Cabinet Replacement Section.
2. Slide the Front Cabinet forward until it is clear from the Base Cabinet.
3. Remove the Compressor Cover. Refer to the Compressor Cover Replacement Section.
4. Disconnect the female connector on the main power wiring harness from the male connector on the Power Switch harness.



**FIGURE AC: LOCATION OF THE MAIN POWER WIRING HARNESS**

5. Note the position of the Power Cord wires in the main power harness female connector. Using an amp terminal retractor, remove the Power Cord wire from the connector.
6. Note the routing of the main power wiring harness and the location of the cable ties securing the harness to the Base Cabinet. Cut the cable ties.
7. Remove the two connectors from the Hour Meter.

### NOTE

*The wires connected to the Hour Meter are interchangeable.*

8. Disconnect the female connector of the main power wiring harness from the male connector on the Compressor wires.

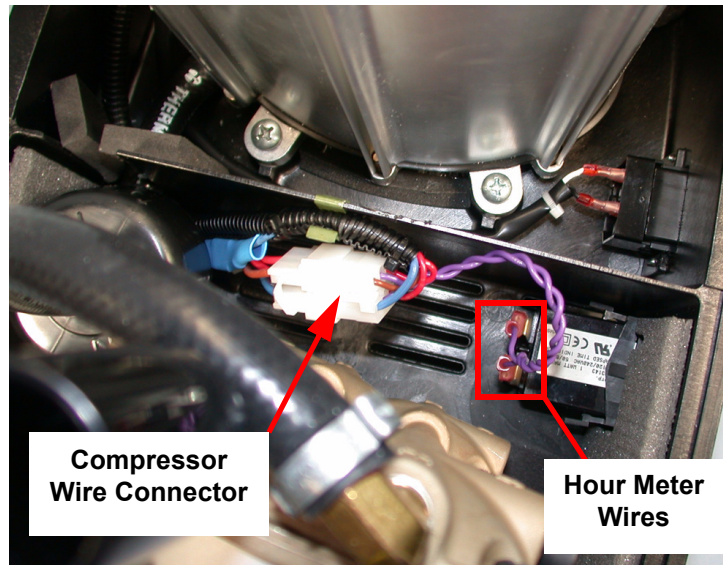


## To install the Main Power Wiring Harness

1. Install the female connector of the main power wiring harness onto the male connector on the Compressor wires.
2. Install the two Hour Meter wires onto the Hour Meter.
3. Route the main power wiring harness along the inside of the Base Cabinet. Secure the main power wiring harness to the Base Cabinet using three cable ties.
4. Install the Power Cord wire connectors in their original position in the main power harness female connector.
5. Install the female connector on the main power wiring harness onto the male connector on the Power Switch wiring harness.
6. Connect the red wires to the Hour Meter terminals.

### NOTE

*The wires connected to the Hour Meter are interchangeable.*



**FIGURE AD: LOCATION OF THE HOUR METER AND COMPRESSOR WIRE CONNECTORS**

## CAPACITOR REPLACEMENT

### To remove the Motor Start/Run Capacitor

1. Remove the Rear Cabinet. Refer to the Rear Cabinet Replacement Section.
2. Slide the Front Cabinet forward until it is clear from the Base Cabinet.
3. Remove the Compressor Cover. Refer to the Compressor Cover Replacement Section.
4. Using insulated needle-nose pliers, carefully remove the female connectors on the Capacitor wires from the two Capacitor terminals.

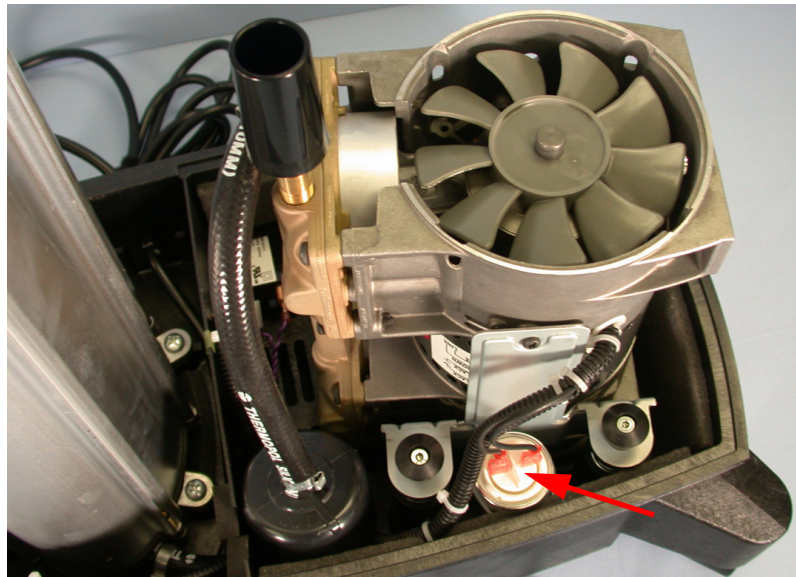
### CAUTION

*Short the terminals of the Capacitor to discharge.*

5. After the Capacitor is discharged, lift the Capacitor up and out of the molded base.

### To install the Motor Start/Run Capacitor

1. Slide the Capacitor into position between the foam insulation and the Compressor assembly standoff.
2. Connect the Capacitor wires to the terminals on the Capacitor.
3. Make sure the Capacitor terminals are parallel to the rear wall in the Base Cabinet.



**FIGURE AE: LOCATION OF THE CAPACITOR**

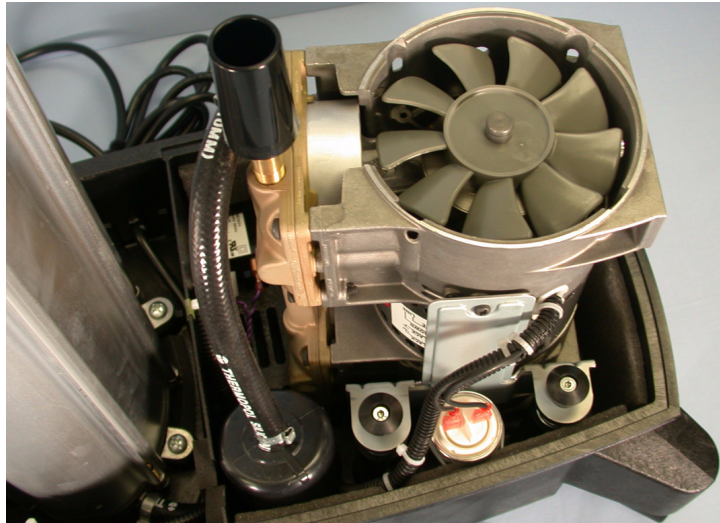
## COMPRESSOR ASSEMBLY REPLACEMENT

### WARNING

*Ensure that the unit is disconnected from the AC power source before beginning this procedure.*

#### To remove the Compressor Assembly

1. Remove the Rear Cabinet. Refer to the Rear Cabinet Replacement Section.
2. Slide the Front Cabinet forward until it is clear from the Base Cabinet.
3. Remove the Compressor Cover. Refer to the Compressor Cover Replacement Section.



**FIGURE AF: COMPRESSOR ASSEMBLY SEATED IN BASE CABINET**

4. Disconnect the Compressor assembly harness from the main power cabinet wiring harness by depressing the locking tabs and separating the connectors.
5. Disconnect the wires from the Capacitor terminals.

### NOTE

*The wires connected to the Capacitor are interchangeable.*

6. Using a crimping clamp tool or diagonals, cut the one-eared clamp securing the pressure tubing to the outlet port of the Compressor assembly. Remove the pressure tubing from the Compressor assembly outlet port.
7. Using a 1/8" hex key wrench or socket, remove the four shoulder screws and rubber bumpers securing the Compressor assembly to the standoffs.
8. Lift the Compressor assembly up from the standoffs and helical springs.

### NOTE

*If the optional Compressor mount kit is being used, remove the four helical springs from the Compressor assembly standoffs.*

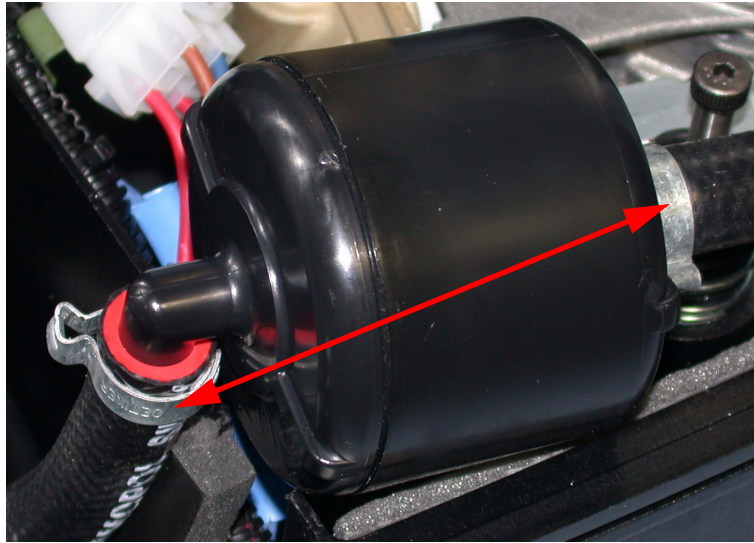
**To install the Compressor Assembly**

1. If the optional Compressor mount kit is being used, install the new helical springs on the top of each Compressor assembly standoff.
2. Align the Compressor/motor assembly with the standoffs and helical springs. Set the Compressor assembly in place.
3. If the optional Compressor mount kit is being used, install the new rubber bumpers on each shoulder screw provided. If the optional Compressor mount kit is not being used, ensure that the rubber bumpers are properly seated on the original shoulder screws.
4. Using a 1/8" hex key wrench or socket, install and tighten the four screws and rubber bumpers that secure the Compressor assembly to the standoffs.
5. Slide the supplied one-eared clamp onto the pressure tubing. Align the tubing with the Compressor assembly outlet port. Slide the tubing onto the ports.
6. Slide the one-eared clamp into position on the pressure tubing. Using a crimping clamp tool or diagonals, firmly "pinch" the one-eared clamp to secure the pressure tubing.
7. Confirm that the In-line Muffler is not touching the side wall of the Base Cabinet or main power wiring harness.
8. Install the Capacitor wire connectors onto the terminals of the Capacitor.
9. Align the female connector on the Compressor assembly wiring harness with the connector on the main power wiring harness. Press the connectors together until completely seated and locked together.

## IN-LINE MUFFLER REPLACEMENT

### To remove the In-line Muffler

1. Remove the Rear Cabinet. Refer to the Rear Cabinet Replacement Section.
2. Slide the Front Cabinet forward until it is clear from the Base Cabinet.
3. Remove the Compressor Cover. Refer to the Compressor Cover Replacement Section.
4. Using a crimping clamp tool or diagonals, cut the two one-eared clamps between the Compressor head and In-line Muffler.



**FIGURE AG: LOCATION OF THE ONE-EARED CLAMPS (IN-LINE MUFFLER SHOWN W/O FOAM)**

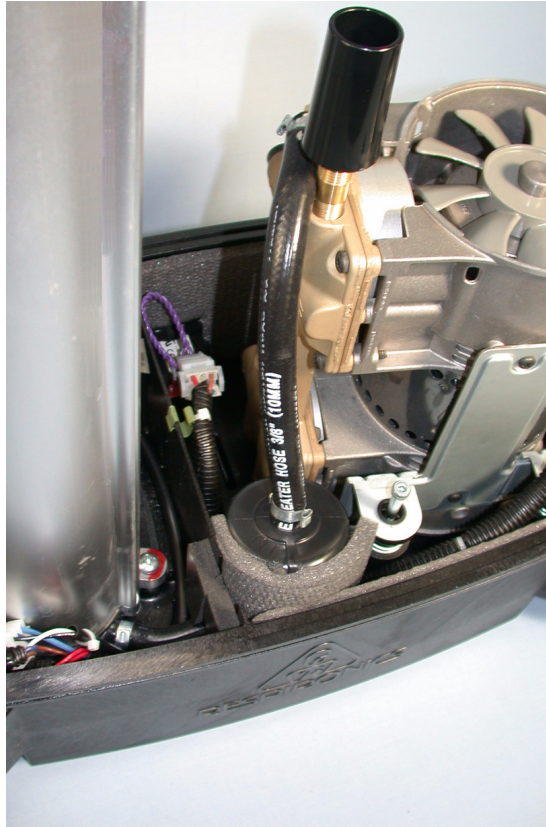
5. Straighten the pressure hose to gain access to the bottom on the In-line Muffler. Cut the one-eared clamp then remove the pressure hose.
6. Remove the In-line Muffler.

### To install the In-line Muffler

1. Slide a new one-eared clamp onto the existing 12" pressure hose. Attach the pressure hose to the "In" port of the In-line Muffler.
2. Wrap foam around the In-line Muffler.

#### **NOTE**

*During installation, position the In-line Muffler so that the foam separates the In-line Muffler from the Base Cabinet Wall.*



**FIGURE AH: PROPER ORIENTATION OF THE IN-LINE MUFFLER**

3. Using a crimping tool or diagonals, firmly “pinch” the one-eared clamp to securely fasten the pressure tubing to the outlet port of the In-line Muffler.
4. Slide a new one-eared clamp onto the 1 3/4” pressure hose connected to the Sieve Canister. Attach the pressure hose to the “Out” port (elbow) of the In-line Muffler.
5. Using a crimping tool or diagonals, firmly “pinch” the one-eared clamp to securely fasten the pressure tubing to the inlet port of the In-line Muffler.
6. Slide a one-eared clamp over the 1 3/4” pressure hose.
7. Align then seat the short pressure tubing on the Compressor assembly’s outlet port.
8. Using a crimping tool or diagonals, firmly “pinch” the one-eared clamp to secure the connections at the Compressor assembly.



5. Spread the tabs on the locking frame out from the Hour Meter.



**FIGURE AK: REMOVAL OF HOUR METER**

6. While holding the tabs spread away from the Hour Meter, push it through the openings in the Base Cabinet.

**To install the Hour Meter**

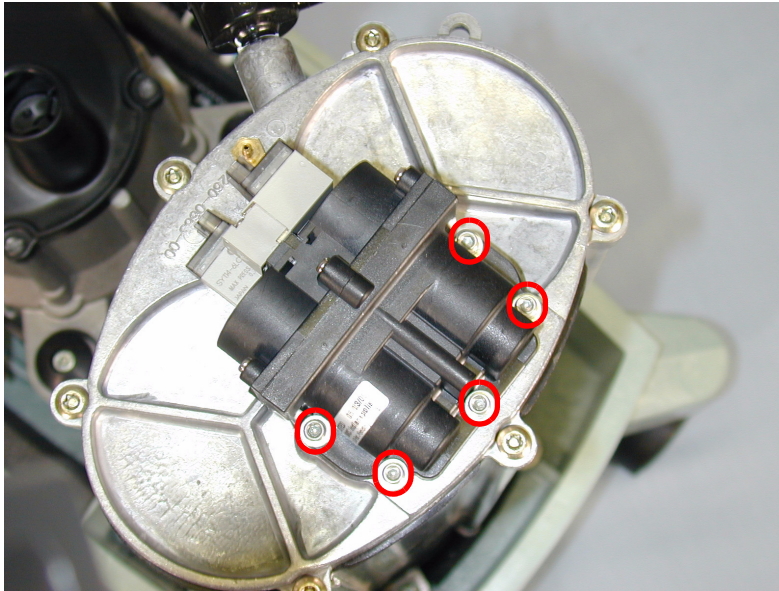
1. Align then insert the Hour Meter into its receptacle in the Base Cabinet.
2. While holding the Hour Meter in place, install the locking frame over the Hour Meter from inside of the Base Cabinet. Press it onto the Hour Meter until it “snaps” in place.
3. Install the Hour Meter wires on the terminals on the back of the Hour Meter.



## VALVE/SOLENOID REPLACEMENT

### To remove the Valve/Solenoid

1. Remove the Rear Cabinet. Refer to the Rear Cabinet Replacement Section.
2. Slide the Front Cabinet forward until it is clear from the Base Cabinet.
3. Remove the two wire connectors from the Valve/Solenoid Assembly.
4. Using a 7/64" hex key wrench or socket, remove the five screws and flat washers securing the Valve/Solenoid to the top of the Sieve Canister Assembly.



**FIGURE A1: SCREW LOCATIONS**

5. Lift the Valve/Solenoid Assembly up and away from the Sieve Canister Assembly.

### To install the Valve/Solenoid Assembly

1. Align the Valve/Solenoid Assembly with the holes in the top of the Sieve Canister Assembly.
2. Using the five screws and flat washers provided, secure the Valve/Solenoid Assembly to the Sieve Canister Assembly. The screws should be torqued sufficiently in order to prevent leaks, but care should be taken not to crush the shoulder of the valve.
3. Reconnect the two wire connectors to the Valve/Solenoid Assembly.
4. Connect the unit to a power source and turn on the device. Apply snoop leak detector to the area where the Valve/Solenoid Assembly mounts to the Sieve Canister Assembly and check for leaks.

## PRESSURE REGULATOR REPLACEMENT

### To remove the Pressure Regulator

1. Remove the Rear Cabinet. Refer to the Rear Cabinet Replacement Section.
2. Slide the Front Cabinet forward until it is clear from the Base Cabinet.
3. Remove the pressure tubing from the outlet port on the pressure regulator.
4. Note the orientation of the pressure regulator outlet port. The new pressure regulator must be installed with the outlet port in the same position.
5. Using a pair of channel locks, remove the pressure regulator from the Sieve Canister Assembly.



**FIGURE AM: REMOVAL OF THE PRESSURE REGULATOR**

### To install the Pressure Regulator

1. Apply a layer of Teflon thread tape to the threads of the pressure regulator.

#### CAUTION

*The tape should be installed in a counter clockwise direction, with the Pressure Regulator threads facing you.*

2. Align the pressure regulator with the pressure regulator port in the Sieve Canister Assembly. Screw the pressure regulator into the Sieve Canister Assembly until strong resistance is felt and the pressure regulator outlet port is oriented in the correct position.

#### NOTE

*Do not overtighten the Pressure Regulator.*

3. Install the pressure tubing on the pressure regulator outlet port.
4. Connect the unit to a power source and turn on the unit. Apply snoop leak detector to the area where the pressure regulator mounts to the Sieve Canister Assembly and where the O<sub>2</sub> tubing connects to the outlet barb to check for leaks.

## SIEVE CANISTER ASSEMBLY REPLACEMENT

### To remove the Sieve Canister Assembly

1. Remove the Rear Cabinet. Refer to the Rear Cabinet Replacement Section.
2. Slide the Front Cabinet forward until it is clear from the Base Cabinet.
3. Remove the Compressor Cover. Refer to the Compressor Cover Replacement Section.
4. Remove the Valve/Solenoid Assembly. Refer to the Valve/Solenoid Replacement Section.
5. Remove the pressure regulator. Refer to the Pressure Regulator Replacement Section.
6. Using a phillips screwdriver, remove the four screws securing the Sieve Canister Assembly to the Base Cabinet.
7. Using a crimping clamp tool or diagonals, cut the one-eared clamp securing the 12" pressure tubing to the inlet port of the Sieve Canister.
8. Remove the 12" pressure tubing from the inlet port of the Sieve Canister.
9. Lift the Sieve Canister Assembly up and out of the Base Cabinet.
10. Remove the Blow Down Muffler from the Sieve Canister Assembly. Refer to the Blowdown Muffler Replacement Section.
11. Remove the brass fitting from the top of the Sieve Canister Assembly.

### To install the Sieve Canister Assembly

1. Install the supplied canister gasket on the bottom of the Sieve Canister Assembly.
2. Install the brass fitting in the top of the Sieve Canister Assembly.
3. Install the Blow Down Muffler onto the Sieve Canister Assembly Refer to the Blowdown Muffler Replacement Section.
4. Set the Sieve Canister Assembly in place in the Base Cabinet.

#### NOTE

*Ensure that the AC Power Cord is clear of the Sieve Canister Assembly.*

5. Slide the one-eared clamp provided onto the 12" pressure tubing.
6. Install the 12" pressure tubing provided on the inlet port of the Sieve Canister.
7. Using a crimping clamp tool or diagonals, "pinch" the one-eared clamp securing the pressure tubing to the inlet port of the Sieve Canister Assembly.
8. Using a phillips screwdriver, insert then tighten the four screws that secure the Sieve Canister Assembly to the molded base.
9. Install the Valve/Solenoid on the top of the Sieve Canister.
10. Install the wire connectors on the terminals of the valve/solenoid.
11. Connect the yellow pressure tubing to the brass fitting on the top of the Sieve Canister.
12. Connect the clear pressure tubing to the port on the pressure regulator.

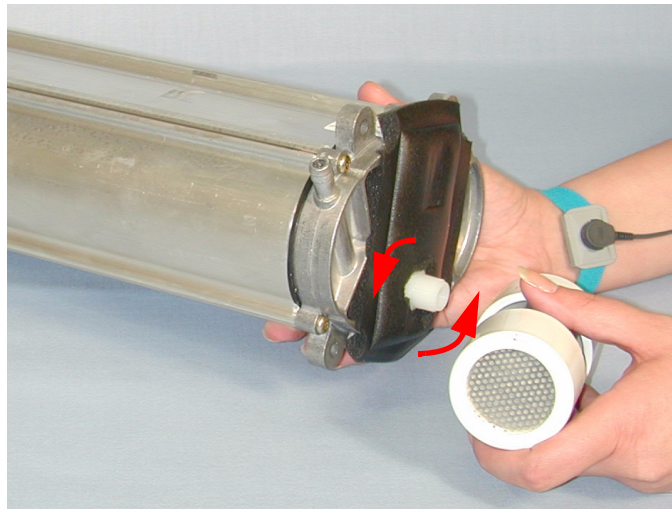
## BLOW DOWN MUFFLER REPLACEMENT

### NOTE

*If care is taken during the following Section, the Valve/Solenoid Assembly and the pressure regulator do not have to be removed. However, if these components are damaged during the procedure, they must be replaced.*

#### To remove the Blow Down Muffler

1. Remove the Rear Cabinet. Refer to the Rear Cabinet Replacement Section.
2. Slide the Front Cabinet forward until it is clear from the Base Cabinet.
3. Remove the Compressor Cover. Refer to the Compressor Cover Replacement Section.
4. Remove the Valve/Solenoid Assembly. Refer to the Valve/Solenoid Replacement Section.
5. Remove the pressure regulator. Refer to the Pressure Regulator Replacement Section.
6. Note the orientation of the blown down muffler in relation to the Sieve Canister Assembly.
7. Using channel locks, turn the Blow Down Muffler counter-clockwise until it is free of the sieve canister assembly.



**FIGURE AN: REMOVING THE BLOW DOWN MUFFLER**

#### To install the Blow Down Muffler

1. Align the Blow Down Muffler with the Sieve Canister Assembly's threaded fitting. Screw the Blow Down Muffler onto the fitting until it comes in contact with the Sieve Canister foam and the Blow Down Muffler is positioned in its original orientation.

## **POWER CORD REPLACEMENT**

### **To Remove the Power Cord**

1. Remove the Rear Cabinet. Refer to the Rear Cabinet Replacement Section.
2. Slide the Front Cabinet forward until it is clear from the Base Cabinet.
3. Remove the Compressor Cover. Refer to the Compressor Cover Replacement Section.
4. Disconnect the main power wiring harness connector from its receptacle on the Power Switch wiring harness. Note the orientation of both the black and white Power Cord wires in the main power wiring harness connector.
5. Using an Amp terminal retractor tool, remove the female connectors of both the black and white Power Cord wires from the main power wiring harness connector.
6. Using a Heyco tool, depress the locking tabs on the AC Power Cord strain relief grommet installed in the Base Cabinet.
7. Once the grommet is free of the Base Cabinet, remove the Power Cord.

### **To Install the Power Cord**

1. Insert the Power Cord wires into the hole in the Base Cabinet.
2. Route the Power Cord wires to the main power wiring harness connector.
3. Align the female connectors on the end of the black and white Power Cord wires with their receptacles in the main power wiring harness connector.
4. Press each Power Cord wire female connector into the main power wiring harness connector until completely sealed.

### **CAUTION**

*The black and white Power Cord wires **MUST** be inserted in the main power wiring harness connector in their original configuration. If they are reversed, damage to the unit will occur.*

5. Align the Power Cord strain relief grommet with the cutout in the Base Cabinet. Press the grommet into the Base Cabinet until completely seated. Using an Amp terminal retractor tool, remove the female connectors of both the black and white Power Cord wires from the main power wiring harness connector.
6. Plug the main power wiring harness connector into its receptacle on the Power Switch wiring harness.
7. Install the Compressor Cover. Refer to the Compressor Cover Replacement Section.
8. Slide the Front Cabinet onto the Base Cabinet.
9. Install the Rear Cabinet. Refer to the Rear Cabinet Replacement Section.

## BASE CABINET REPLACEMENT

### NOTE

*If care is taken during the following Section, the Valve/Solenoid Assembly and the pressure regulator do not have to be removed. However, if these components are damaged during the procedure, they must be replaced.*

#### To Remove the Base Cabinet

1. Remove the Rear Cabinet. Refer to the Rear Cabinet Replacement Section.
2. Slide the Front Cabinet forward until it is clear from the Base Cabinet.
3. Remove Compressor Cover/Perforated Canopy. Refer to the Compressor Cover Replacement Section
4. Remove Capacitor. Refer to the Motor Run/Start Capacitor Replacement Section.
5. Remove Compressor/motor assembly. Refer to Compressor/Motor Assembly Replacement Section.
6. Remove In-line Muffler. Refer to In-line Muffler Replacement Section.
7. Remove Hour Meter. Refer to Hour Meter Replacement Section.
8. Remove Sieve Canister Assembly. Refer to Sieve Canister Replacement Section.
9. Remove Power Cord. Refer to Power Cord Replacement Section.

#### To Install the Base Cabinet

1. All components have now been removed from the original Base Cabinet. To begin reassembly, place the Base Cabinet on a protected work surface. Follow the disassembly process in reverse order to reassemble the unit.

*This page intentionally left blank.*



## ENHANCED M600/M605; ENHANCED M10600/M10605 CONCENTRATOR REPAIR & REPLACEMENT

### SECTION OVERVIEW

This chapter illustrates the repair and replacement procedures for the components of the Millennium Oxygen Concentrators. Once repair is complete refer to the testing section for proper testing procedures.

#### WARNINGS

- *To prevent electrical shock, disconnect the electrical supply before attempting to make any device repairs to the Millennium Oxygen Concentrators.*
- *Use extreme caution when handling the Compressor/motor assembly Capacitor. The Capacitor can hold a substantial electrical charge until it is properly discharged.*
- *Avoid handling the molecular sieve material. Respironics recommends the return of the Sieve Canister Assembly to Respironics for any service that involves sieve material disposal.*
- *Even with the unit disconnected from the electrical supply, the Capacitor may still hold an electrical charge strong enough to cause serious bodily injury. DO NOT touch the Capacitor terminals simultaneously until the Capacitor has been completely discharged. Discharge the Capacitor by shorting the two posts with an insulated screw driver.*

#### CAUTIONS

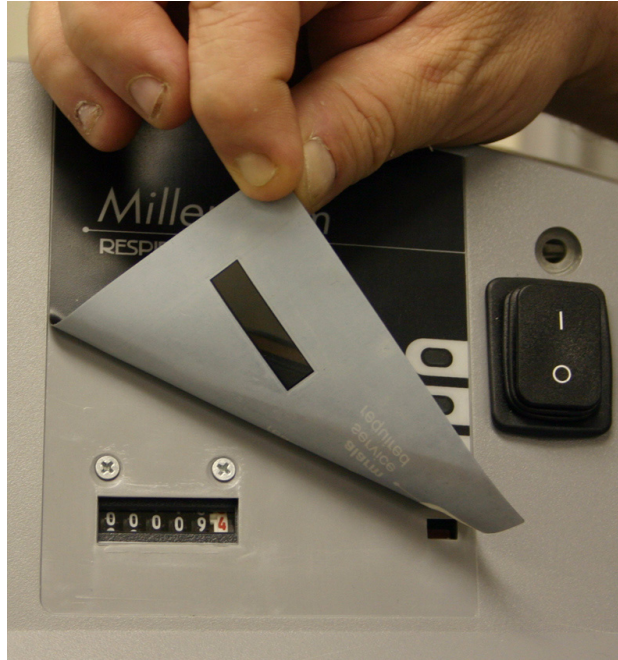
- *Electronic components used in this unit are subject to damage from static electricity. Repairs made to this unit must be performed only in an antistatic, ESD-protected environment.*
- *During all repair and replacement procedures, assure that any connections that are broken during the process (fittings, tubing, and hoses) are reconnected securely.*
- *When using leak detector, be careful that it does not come in contact with any electrical components.*
- *The fuse on the power control board must be replaced with a fuse of the same rating as the original. Failure to do so will result in damage to the unit.*



## OVERLAY REPLACEMENT

### To remove the Overlay

1. Starting at one corner, carefully peel the Overlay off of the cabinet.



**FIGURE A: REMOVING THE OVERLAY**

2. Use a small amount of isopropyl alcohol applied to a cleaning cloth to remove any adhesive residue from the cabinet.

### NOTE

*When using isopropyl alcohol to clean the mounting area for the control Overlay, ensure that no liquid enters the Front Cabinet or comes into contact with the LEDs. Use protective glasses.*

### To install the Overlay

1. Remove the protective backing from the Overlay.
2. Carefully align the Overlay with the applicable mounting area. Set the Overlay in place and, using a circular motion, firmly rub the Overlay until it is securely attached to the cabinet.

## CASTER REPLACEMENT

### To remove the Casters

1. Place the unit on a protected work surface and carefully lay the unit over its Rear Cabinet.
2. While holding the unit firmly in place, grasp the Caster to be replaced and pull it firmly out of its receptacle in the molded base.



**FIGURE B: CASTER REMOVAL**

### NOTE

*It may be necessary to insert a medium flat-blade screwdriver between the Caster and the molded base to “pry” the Caster from its receptacle. Once the Caster has been partially removed, a rubber mallet can be used to completely remove the Caster from its receptacle. If this is necessary, care should be taken to prevent damage to the molded case.*

3. If more than one Caster is to be replaced, repeat the procedure for each Caster to be replaced.

### To install the Casters

1. Align the Caster shaft with its receptacle in the molded base.
2. While holding the unit in place, firmly push the Caster into its receptacle until completely seated.

### NOTE

*It may be necessary to use a rubber mallet to gently tap the Caster into the molded base. If this is necessary, care should be taken to prevent damage to the molded case. In some cases, use water to lubricate the post.*

3. If more than one Caster is being replaced, repeat the procedure for each Caster being replaced.
4. Carefully return the unit to the upright position.

## BASE CABINET PAN REPLACEMENT

### To remove the Base Cabinet Pan

1. Place the unit on a protected work surface and carefully lay the unit over its Rear Cabinet.
2. Remove the six Phillips screws securing the Base Cabinet pan to the Base Cabinet.

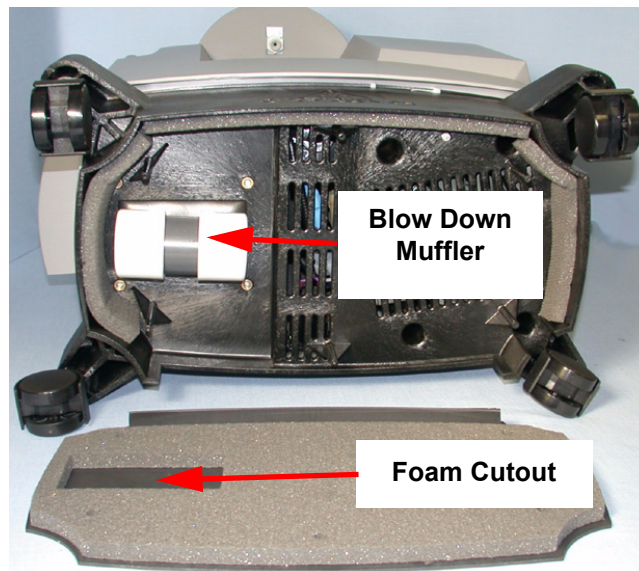


**FIGURE C: SCREW LOCATION**

3. Grasp the back edge of the Base Cabinet pan and remove it from the Base Cabinet.

### To install the Base Cabinet Pan

1. Position the Base Cabinet pan so the cut-out in the foam insulation aligns with the Blow Down Muffler.



**FIGURE D: BLOW DOWN MUFFLER AND FOAM CUTOUT**

2. Align the Base Cabinet pan with the Base Cabinet and set it into place.
3. Insert and gently tighten the six Phillips screws provided to secure the Base Cabinet pan to the Base Cabinet.

## REAR CABINET REPLACEMENT

### To remove the Rear Cabinet

1. Remove the filter from side of cabinet.
2. Using a Phillips screwdriver, remove the six screws that secure the Rear Cabinet to the Front Cabinet.



**FIGURE E: FRONT CABINET SCREW LOCATION**

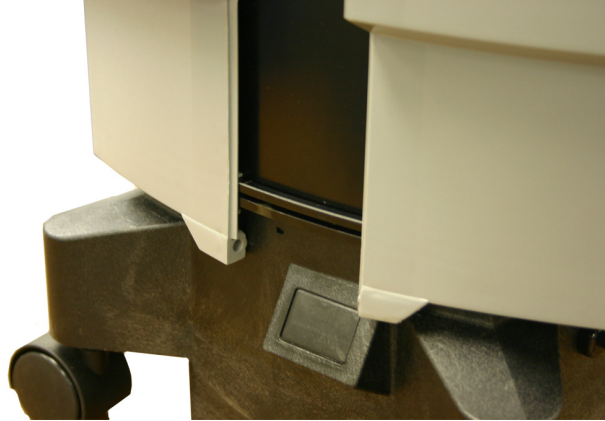
3. Grasp the Rear Cabinet firmly then slide it toward the back of the unit until it is clear of the guide slot on the Base Cabinet. Once clear of the guide slot, the Rear Cabinet can be lifted away from the unit.

## To install the Rear Cabinet

### NOTE

*The Base Cabinet has a guide slot to ensure proper alignment of the rear and Front Cabinets. The rear and Front Cabinets MUST be properly aligned with the guide slot to ensure correct installation.*

1. Align the ridges on the Rear Cabinet with the guide slot in the Base Cabinet.



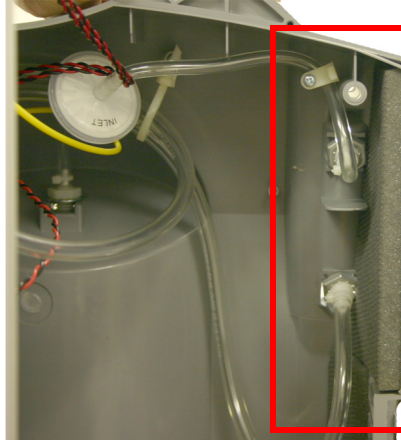
**FIGURE F: FRONT CABINET ALIGNMENT WITH GUIDE SLOT**

2. Once the guide slot and ridges are correctly aligned, hold the Front Cabinet in place while sliding the Rear Cabinet onto the Base Cabinet.
3. Using a Phillips screwdriver, install and secure the six mounting screws securing the Rear Cabinet to the Front Cabinet.
4. Torque the six screws to  $15 \pm 1$  inch lbs.

## FLOW METER REPLACEMENT

### To remove the Flow Meter

1. Remove the Rear Cabinet. Refer to the Rear Cabinet Replacement Section.
2. Slide the Front Cabinet forward until it is clear from the Base Cabinet.
3. Working from inside the Front Cabinet, cut the cable ties then remove the pressure tubing from both fittings on the Flow Meter by pulling the tubing from each fitting.



**FIGURE G: VIEW OF FLOW METER FROM INSIDE THE FRONT CABINET**

### NOTE

*The pressure tubing connected to the top fitting on the Flow Meter is connected to the bacteria filter. The pressure tubing connected to the bottom fitting is connected to the OPI sensor for Model 605, or the 1/2" tubing in the wiring harness for Model 600.*

4. While holding the Flow Meter in place, remove the two speed nuts from the threaded fittings on the back of the Flow Meter.
5. Remove the Flow Meter from the Front Cabinet assembly by pulling it straight out from the Front Cabinet.

**To install the Flow Meter**

1. Align the threaded fittings on the back of the supplied Flow Meter with the holes in the Front Cabinet.

**NOTE**

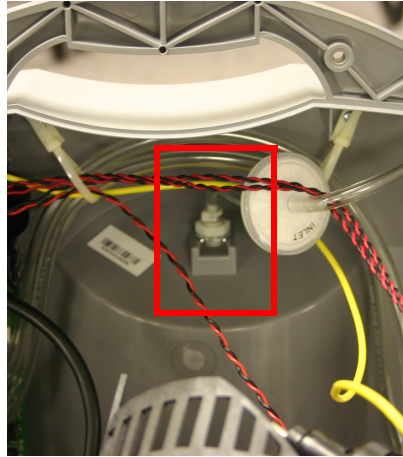
*The Flow Meter must be mounted with the shaft for the Flow Meter knob at the top.*

2. While holding the Flow Meter in place, install the support speed nuts to secure the Flow Meter to the Front Cabinet. Hand tighten the speed nuts.
3. Connect the pressure tubing to the fittings on the Flow Meter, then secure the tubing with the cable ties.
4. Turn on the unit, and check the flow tube connections for leaks.
5. If no leaks are detected, turn off the unit, reassemble, and test.

## DISS OUTLET FITTING REPLACEMENT

### To remove the DISS Outlet Fitting

1. Remove the Rear Cabinet. Refer to the Rear Cabinet Replacement Section.
2. Slide the Front Cabinet forward until it is clear from the Base Cabinet.
3. Cut the cable tie then remove the pressure tubing connected to the DISS outlet fitting by pulling it off the fitting.



**FIGURE H: VIEW OF DISS FROM INSIDE THE FRONT CABINET**

4. While holding the DISS outlet fitting in place, use an 11/16" wrench to loosen the nylon jam nut securing the DISS outlet fitting.
5. Remove the DISS outlet fitting from the Front Cabinet.



**FIGURE I: DISS FITTING REMOVAL**

### To install the DISS Outlet Fitting

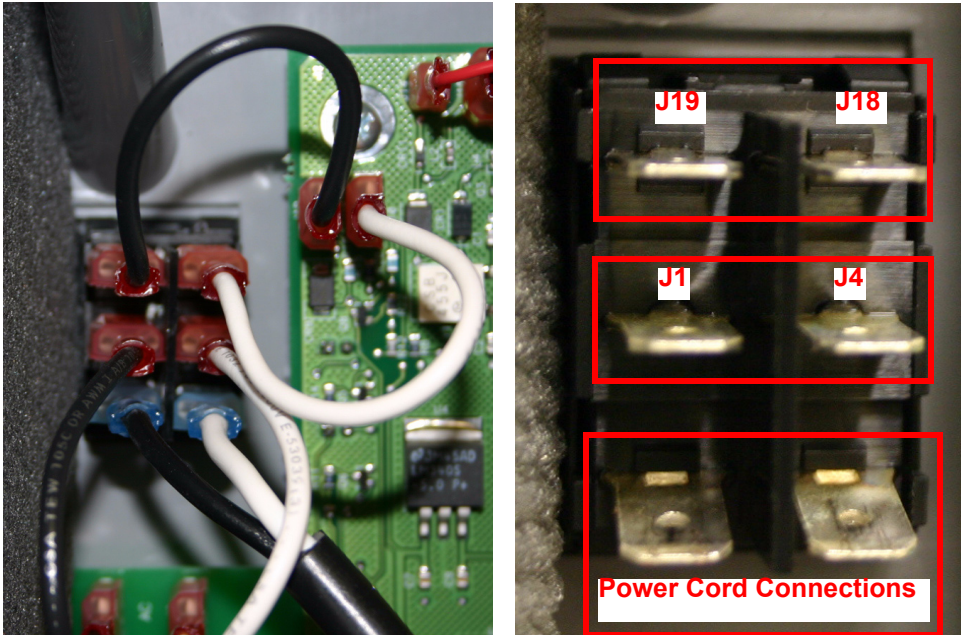
1. Align the DISS outlet fitting with the opening in the Front Cabinet. Insert the DISS outlet fitting into the opening.
2. While holding the DISS outlet fitting in place, install the new lock washer and nylon jam nut on the DISS outlet fitting. Use an 11/16" wrench to carefully tighten the nylon jam nut.
3. Connect the pressure tubing to the fittings on the DISS outlet fitting. Secure the tubing to the fitting with the cable tie provided.



## POWER SWITCH REPLACEMENT

### To remove the Power Switch

1. Remove the Rear Cabinet. Refer to the Rear Cabinet Replacement Section.
2. Slide the Front Cabinet forward until it is clear from the Base Cabinet.
3. Looking at the back of the Power Switch from inside the Front Cabinet, note the position and colors of the wires connected to the terminals on the Power Switch (black inputs go on the left side and white inputs go on the right side).



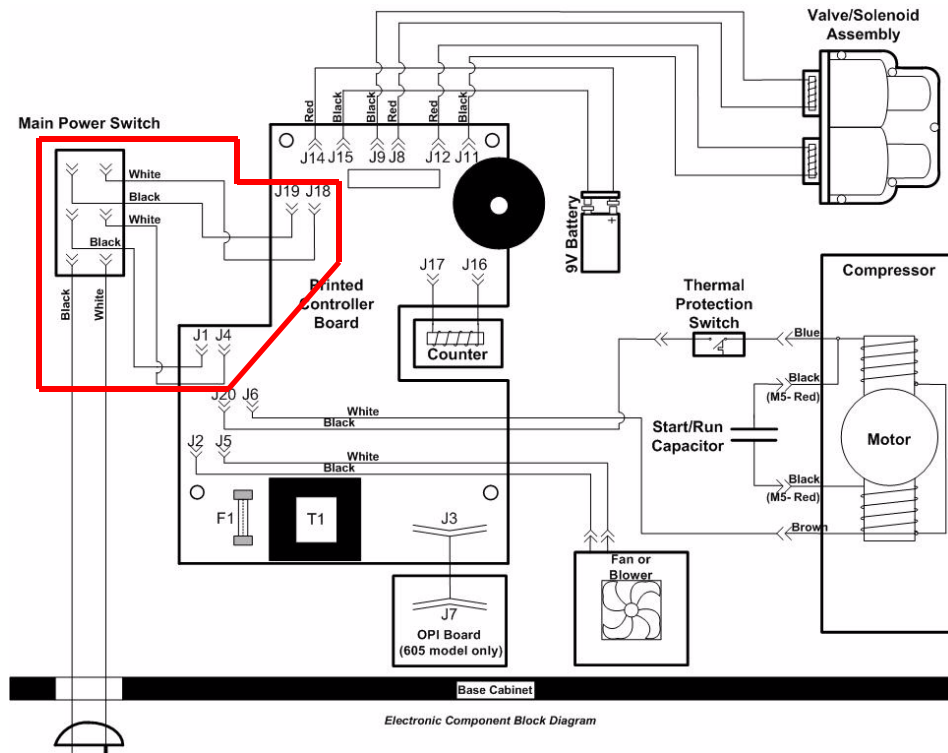
**FIGURE J: POWER SWITCH CONNECTIONS**

4. Using needle nose pliers, remove the wires from the Power Switch terminals. Using your fingers or a small flat-blade screwdriver, depress the latches on each corner of the Power Switch.
5. While depressing the latches, push the Power Switch out of the Front Cabinet assembly.

### To install the Power Switch

1. Orient the Power Switch so that the single terminal is at the top. Align the Power Switch with the opening in the Front Cabinet assembly. Press the Power Switch into the Front Cabinet assembly until all four latches on the Power Switch lock in place.
2. Install the wires onto the terminals of the Power Switch. Ensure that they are installed in their original position. Refer to Figure J for a detailed illustration.

## MAIN PCB TO POWER SWITCH WIRING REPLACEMENT



**FIGURE K: ELECTRICAL BLOCK DIAGRAM**

### WARNING

*Make sure the AC power is disconnected.*

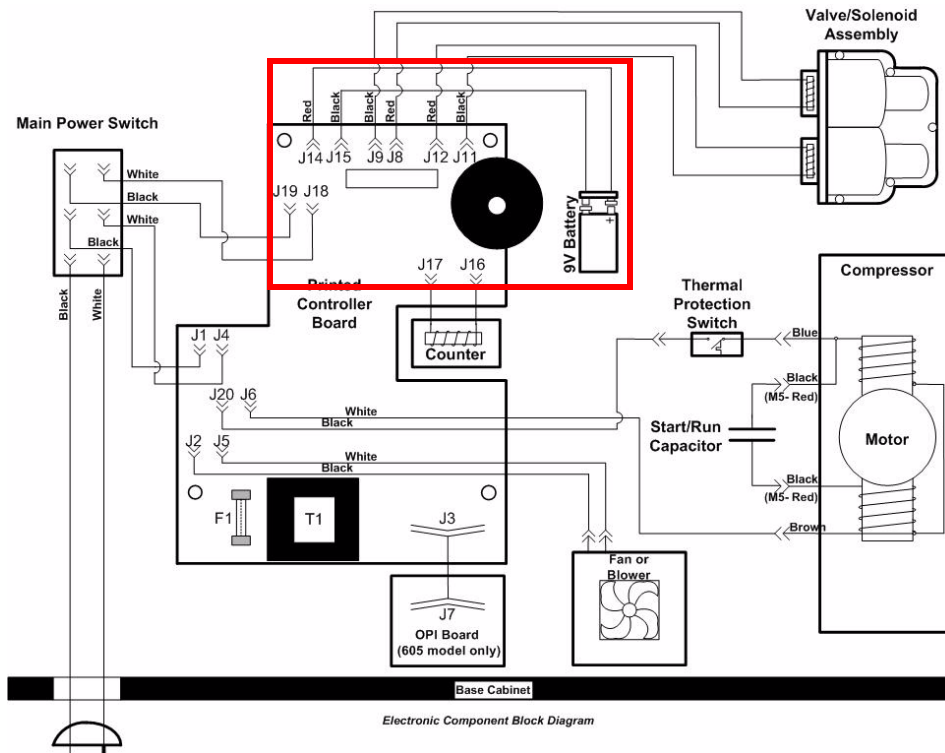
#### To remove the Main PCB to Power Switch Wiring

1. Remove the Rear Cabinet. Refer to the Rear Cabinet Replacement Section.
2. Slide the Front Cabinet forward until it is clear from the Base Cabinet.
3. Using needle nose pliers, remove the connectors from the terminals J1, J4, J18, and J19 of the Main PCB.
4. Looking at the back of the Power Switch from inside the Front Cabinet, note the position and colors of the wires connected to the terminals on the Power Switch.
5. Using needle nose pliers, remove the connectors from the Power Switch terminals.

#### To install the Main PCB to Power Switch Wiring

1. Install the connectors onto the proper terminals of the Power Switch. Ensure that they are installed in their original position. Refer to the block diagram in Figure K.
2. Install the wire connectors from the Power Switch to terminals J1, J4, J18, and J19 of the Main PCB. Refer to the block diagram in Figure K.

## MAIN PCB TO BATTERY WIRING REPLACEMENT



**FIGURE L: ELECTRICAL BLOCK DIAGRAM**

### WARNING

*Make sure the AC power is disconnected.*

#### To remove the Main PCB to Battery Wiring

1. Remove the Rear Cabinet. Refer to the Rear Cabinet Replacement Section.
2. Slide the Front Cabinet forward until it is clear from the Base Cabinet.
3. Remove battery from Compressor Cover.
4. Remove the battery connector from the battery.
5. Remove the battery wiring harness connectors from terminals J14 and J15 on the Main PCB assembly. Refer to Figure L.

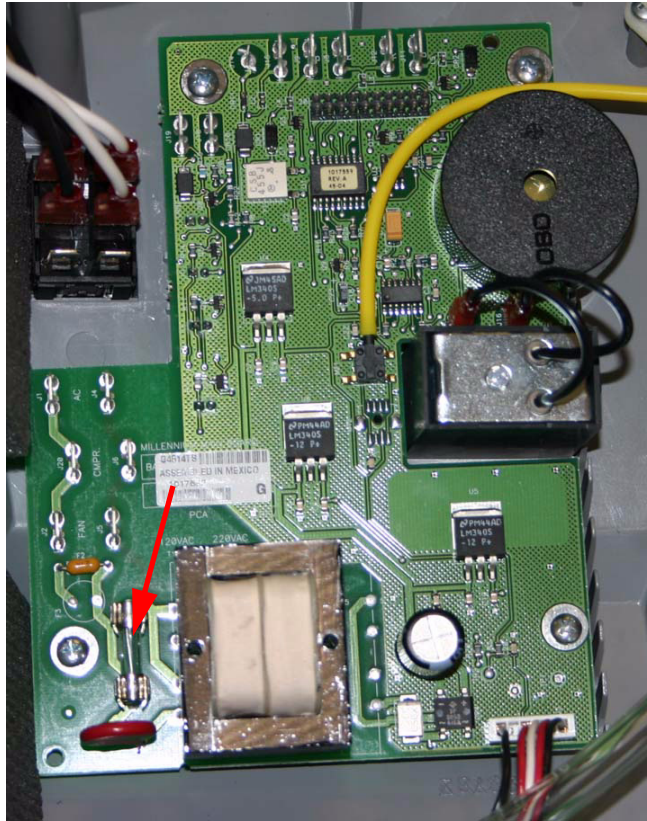
#### To remove the Main PCB to Battery Wiring

1. Connect the battery wiring harness connectors to terminal J14 and J15 on the Main PCB. Refer to Figure L.
2. Connect the battery connector to the battery.
3. Install the battery into the Compressor Cover.
4. Slide the Front Cabinet onto the Base Cabinet.
5. Install the Rear Cabinet. Refer to the Rear Cabinet Replacement Section.

## MAIN PCB FUSE REPLACEMENT

### To remove the Fuse

1. Remove the Rear Cabinet. Refer to the Rear Cabinet Replacement Section.
2. Slide the Front Cabinet forward until it is clear from the Base Cabinet.
3. Using a fuse extractor, remove the fuse from its receptacle on the Main PCB.

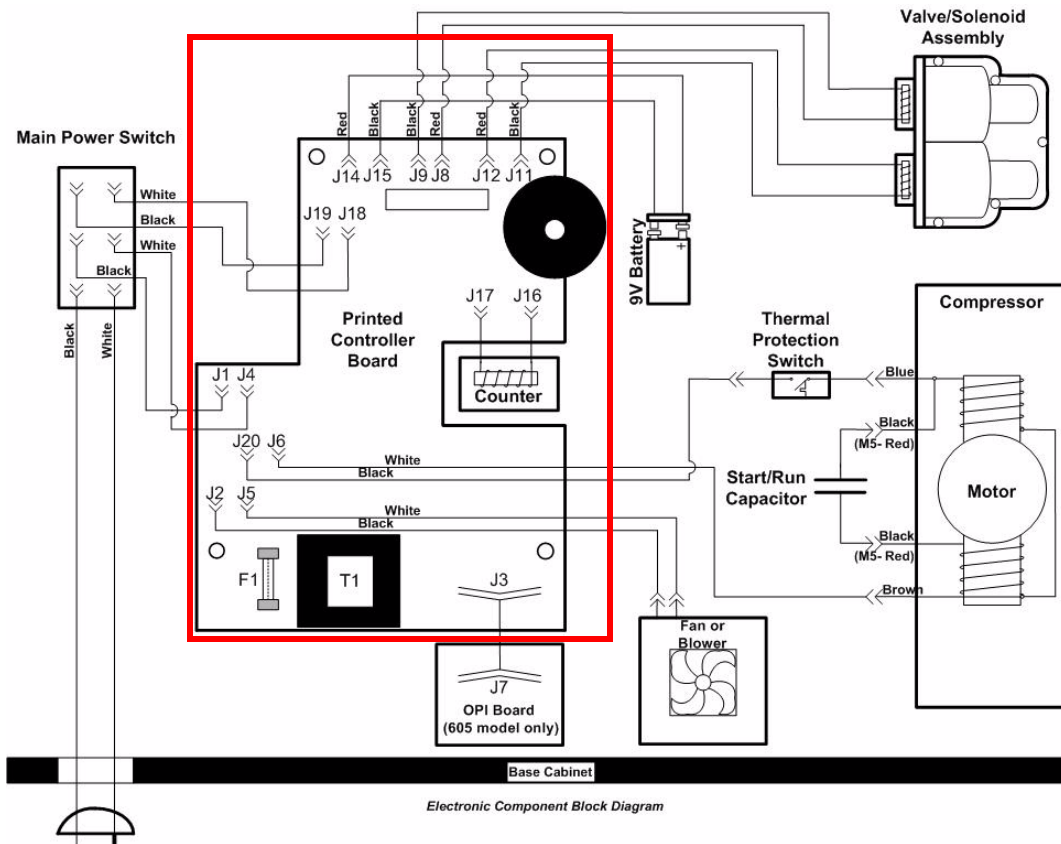


**FIGURE M: FUSE LOCATION**

### To install the Fuse

1. Align the fuse with its receptacle on the Main PCB.
2. Carefully press the fuse into its receptacle until completely seated.

## MAIN PCB REPLACEMENT

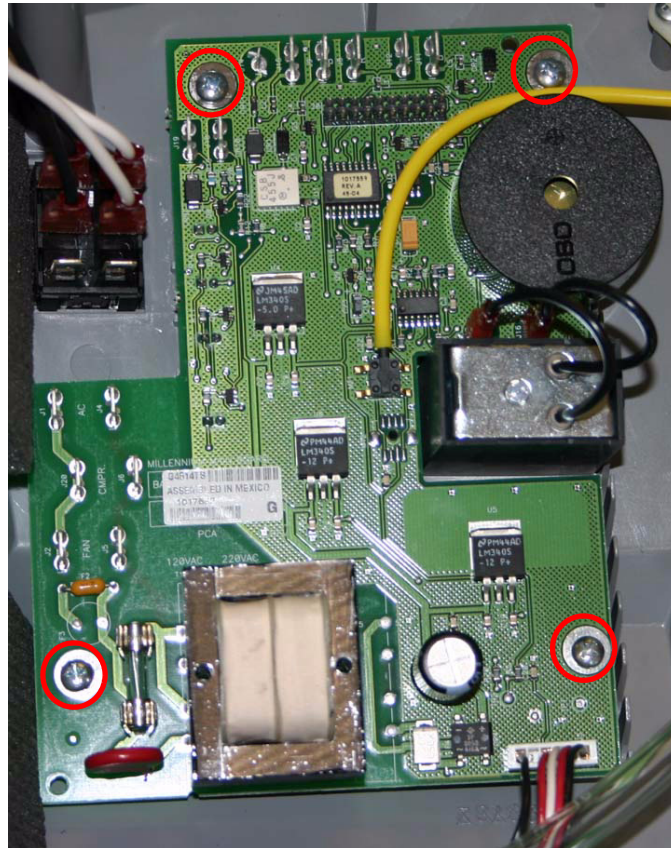


**FIGURE N: ELECTRONIC COMPONENT BLOCK DIAGRAM**

### To remove the Main PCB

1. Remove the Rear Cabinet. Refer to the Rear Cabinet Replacement Section.
2. Slide the Front Cabinet forward until it is clear from the Base Cabinet.
3. While holding the pressure transducer, remove the thin yellow pressure tubing from the pressure transducer by carefully pulling the tubing off the fitting.
4. Remove the battery wiring harness connectors from the terminal locations J14 and J15 location on the Main PCB assembly. Refer to the block diagram in Figure N.
5. Remove the valve solenoid wiring connectors from the terminal locations J8, J9, J11, and J12 on the Main PCB assembly. Refer to the block diagram in Figure N.
6. Remove the Power Switch wiring connectors from the terminal locations J18, J19, J1, and J4 on the Main PCB assembly. Refer to the block diagram in Figure N.
7. Remove the Compressor wiring connectors from terminal locations J6 and J20 on the Main PCB assembly. Refer to the block diagram in Figure N.
8. Remove the Cooling fan wiring connectors from terminal locations J5 and J2 on the Main PCB assembly. Refer to the block diagram in Figure N.
9. **For Model 605 units Only:** Remove the OPI wiring harness connector from the J3 location on the Main PCB assembly by pulling the connector directly up from the J3 receptacle.

- Using a Phillips screwdriver, remove the four screws securing the Main PCB assembly to the Front Cabinet. While holding the wiring harness out of the way, remove the Main PCB assembly from the Front Cabinet assembly.



**FIGURE O: SCREW LOCATIONS**

### To install the Main PCB

1. While holding the wiring harnesses out of the way, align the holes in the Main PCB assembly with the standoffs on the Front Cabinet assembly.
2. Insert then hand tighten the four screws provided to secure the Main PCB assembly to the Front Cabinet assembly.
3. Install the wiring from the Cooling Fan to the following terminals on the Main PCB assembly, White wire to J5 and black wire to J2 terminals. Refer to the block diagram in Figure N.
4. Install the wiring from the Compressor to the following terminals on the Main PCB assembly, white wire to J6 and black wire to J20 terminals. Refer to the block diagram in Figure N.
5. Install the wiring from the Power Switch to the following terminals on the Main PCB assembly, white wire J18, black wire J19, white wire J4 and black wire J1 terminals. Refer to the block diagram in Figure N.
6. Install the wires from the valve solenoid to the to the following terminals on the Main PCB assembly, black wire J9, red wire J8, black wire J11 and red wire J12 terminals. Refer to the block diagram in Figure N.
7. Install the wires from the battery to the following terminals on the Main PCB assembly, red wire J14 and black wire J15 terminals. Refer to the block diagram in Figure N.
8. While holding the pressure transducer, install the thin yellow pressure tubing onto the pressure transducer by firmly and carefully pushing the tubing onto the fitting.
9. **For Model 605 units Only:** Align the connector on the short OPI wiring harness with the J3 receptacle on the Main PCB assembly. Carefully press the connector onto the receptacle until completely seated.

## OPI PCB REPLACEMENT (MODEL 605 ONLY)

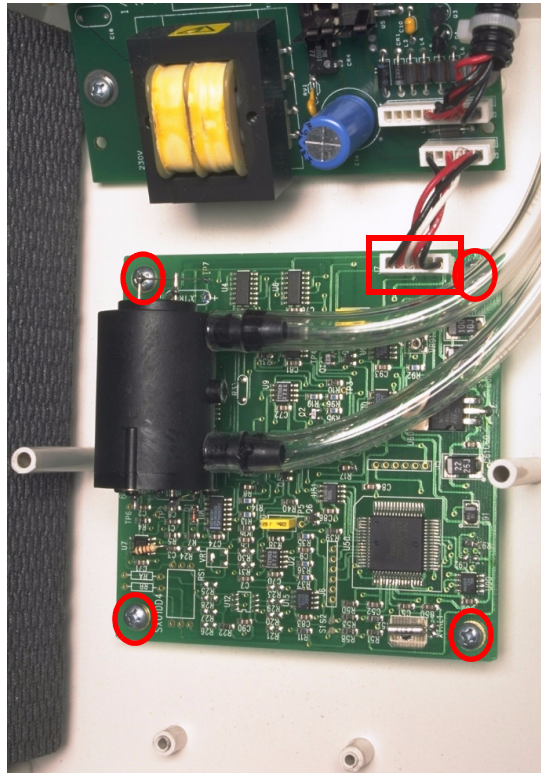
### To remove the OPI Board

1. Remove the Rear Cabinet. Refer to the Rear Cabinet Replacement Section.
2. Slide the Front Cabinet forward until it is clear from the Base Cabinet.
3. Remove the OPI wiring harness connector from the J7 location on the OPI board by pulling the connector directly up from the J7 receptacle.
4. While holding the oxygen sensor, remove the pressure tubing from the sensor by carefully prying the tubing off both oxygen sensor fittings.

### NOTE

*The pressure tubing from the Flow Meter is connected to the top fitting on the oxygen sensor. The pressure tubing connected to the pressure regulator on the Sieve Canister Assembly is connected to the bottom fitting on the oxygen sensor.*

5. Using a Phillips screwdriver, remove the four screws securing the OPI board to the Front Cabinet.



**FIGURE P: CONNECTION AND MOUNTING SCREW LOCATIONS**

6. While holding the wiring harness out of the way, remove the OPI board from the Front Cabinet.



**To install the OPI Board**

1. Align the holes in the OPI board with the standoffs on the Front Cabinet.
2. Insert then tighten the four screws provided to secure the OPI board to the Front Cabinet.
3. While holding the oxygen sensor, install the pressure tubing on the oxygen sensor by carefully pushing the tubing onto the oxygen sensor fittings.
4. Align the connector on the OPI wiring harness with the J7 receptacle on the OPI board. carefully press the connector onto the receptacle until completely seated.

**NOTE**

*Once the unit is reassembled, verify that there are no O<sub>2</sub> leaks. Set the Flow Meter to 0 lpm. Ensure the “no flow” alert activates. The alert should activate. If not, check for leaks at newly installed OPI board.*

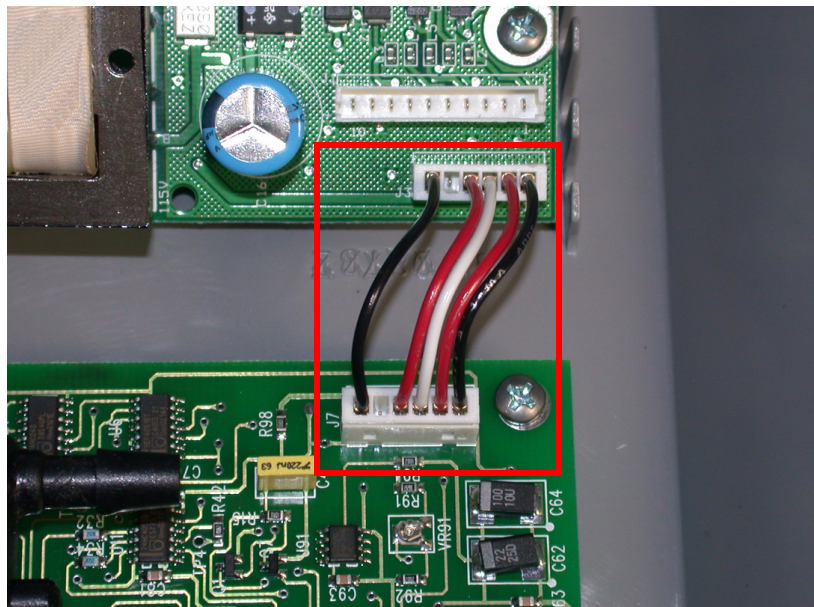
## OPI WIRING HARNESS REPLACEMENT (MODEL 605 ONLY)

### WARNING

*Make sure the AC power is disconnected.*

#### To remove the OPI Wiring Harness

1. Remove the Rear Cabinet. Refer to the Rear Cabinet Replacement Section.
2. Slide the Front Cabinet forward until it is clear from the Base Cabinet.
3. Remove the OPI wiring harness connector from the J3 location on the Main PCB assembly by pulling the connector directly up from the J3 receptacle.
4. Remove the OPI wiring harness connector from the J7 location on the OPI board by pulling the connector directly up from the J7 receptacle.



**FIGURE Q: OPI WIRING HARNESS**

#### To install the OPI Wiring Harness

1. Align the connector on the OPI board wiring harness with the J7 receptacle on the OPI board. Carefully press the connector onto the receptacle until completely seated.
2. Align the connector on the OPI wiring harness with the J3 receptacle on the Main PCB assembly. Carefully press the connector onto the receptacle until completely seated.

## **FRONT CABINET REPLACEMENT**

### **To remove the Front Cabinet**

1. Remove the Rear Cabinet. Refer to the Rear Cabinet Replacement Section.
2. Slide the Front Cabinet forward until it is clear from the Base Cabinet.
3. Remove the Flow Meter. Refer to the Flow Meter Replacement Section.
4. Remove the DISS outlet fitting. Refer to the DISS Outlet Fitting Replacement Section.
5. Remove the Hour Meter. Refer to the Hour Meter Replacement Section.
6. Remove the battery wiring harness. Refer to the Main PCB to Battery Wiring Replacement Section.
7. Remove the Power Switch. Refer to the Power Switch Replacement Section.
8. Remove the OPI Wiring Harness. Refer to the OPI Wiring Harness Replacement (Model 605 Only) Section.
9. Remove the Main PCB. Refer to the Main PCB Replacement Section.
10. Remove the OPI board. Refer to the OPI PCB Replacement (Model 605 Only) Section.

### **To install the Front Cabinet**

1. Position the Front Cabinet face down on a protected work surface that will not damage the Front Cabinet.
2. Install the OPI Board. Refer to the OPI PCB Replacement (Model 605 Only) Section.
3. Install the Main PCB. Refer to the Main PCB Replacement Section.
4. Install the OPI Wiring Harness. Refer to the OPI Wiring Harness Replacement (Model 605 Only) Section.
5. Install the Hour Meter. Refer to the Hour Meter Replacement Section.
6. Install the Power Switch. Refer to the Power Switch Replacement Section.
7. Install the Main PCB to Battery Wiring Harness. Refer to the Main PCB to Battery Wiring Replacement Section.
8. Install the Power Switch harness. Refer to the Main PCB to Power Switch Wiring Replacement Section.
9. Install the DISS outlet fitting. Refer to the DISS Outlet Fitting Replacement Section.
10. Install the Flow Meter. Refer to the Flow Meter Replacement Section.
11. Slide the Front Cabinet onto the Base Cabinet.

12. Install the Rear Cabinet. Refer to the Rear Cabinet Replacement Section.



**FIGURE R: SCREW LOCATIONS**

## COOLING FAN REPLACEMENT

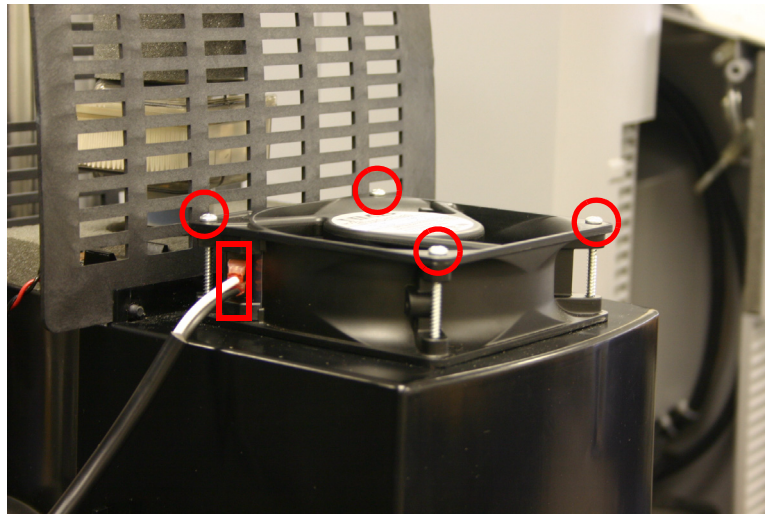
### To remove the Cooling Fan

1. Remove the Rear Cabinet. Refer to the Rear Cabinet Replacement Section.
2. Slide the Front Cabinet forward until it is clear from the Base Cabinet.
3. Remove the two wires from the terminals located on the side of the cooling fan.

**NOTE**

*The two wires are interchangeable.*

4. Using a small, thin shaft Phillips screwdriver, remove the four screws securing the cooling fan to the Compressor Cover.



**FIGURE S: COOLING FAN SCREW AND WIRE LOCATIONS**

5. While holding the Compressor Cover in place, lift the fan up and away from the Compressor Cover.

### To install the Cooling Fan

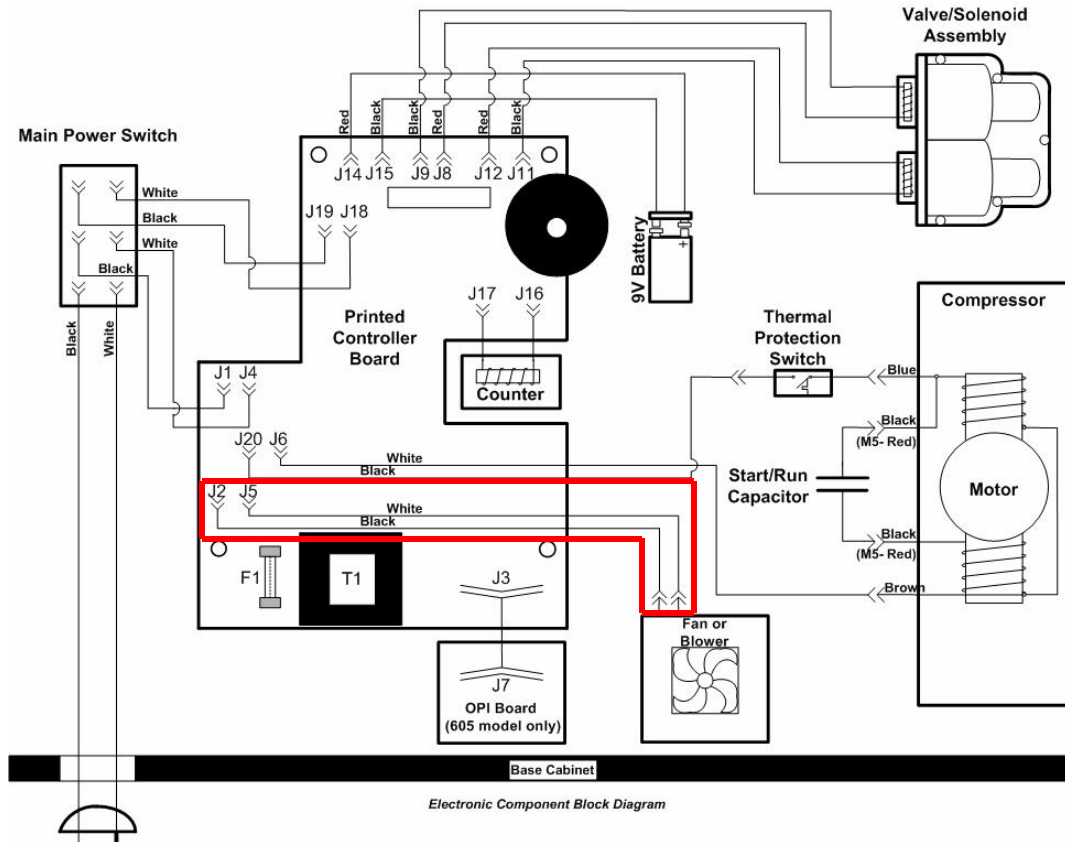
1. Align the cooling fan with the holes in the Compressor Cover.

**NOTE**

*The fan must be installed so the terminals are oriented towards the front and center of the unit.*

2. Insert then tighten the four screws to secure the fan to the Compressor Cover.
3. Connect the fan wires to the terminals on the side of the cooling fan.
4. Slide the Front Cabinet onto the Base Cabinet.
5. Install the Rear Cabinet. Refer to the Rear Cabinet Replacement Section.

## MAIN PCB TO COOLING FAN WIRING REPLACEMENT



**FIGURE T: ELECTRICAL BLOCK DIAGRAM**

### WARNING

*Make sure the AC power is disconnected.*

#### To remove the Main PCB to Cooling Fan Wiring

1. Remove the Rear Cabinet. Refer to the Rear Cabinet Replacement Section.
2. Slide the Front Cabinet forward until it is clear from the Base Cabinet.
3. Remove the connectors on the Main PCB to fan wiring from the terminals on the cooling fan.
4. Remove the wire connectors from the terminals J2 and J5 on the Main PCB assembly. Refer to Figure T.

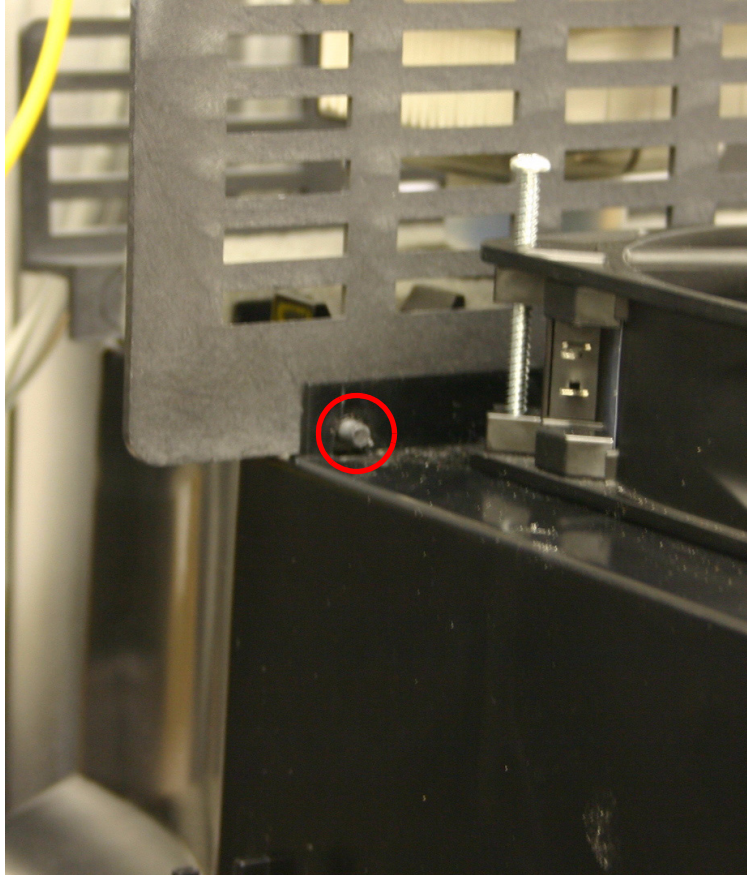
#### To install the Main PCB to Cooling Fan Wiring

1. Install the connectors of the Main PCB to cooling fan wiring to the J2 and J5 terminals on the Main PCB assembly. Ensure that the wires are fully seated on the Main PCB assembly. Refer to Figure T.
2. Install the connectors to the terminals on the cooling fan assembly. Ensure that the wires are fully seated.

## PERFORATED CANOPY REPLACEMENT

### To remove the Perforated Canopy

1. Remove the Rear Cabinet. Refer to the Rear Cabinet Replacement Section.
2. Slide the Front Cabinet forward until it is clear from the Base Cabinet.
3. Press inward on the bottom of each side of the Perforated Canopy until the locating posts are clear of the holes in the Compressor Cover.



**FIGURE U: LOCKING POST LOCATION**

4. Lift the Perforated Canopy up and away from the Compressor Cover.

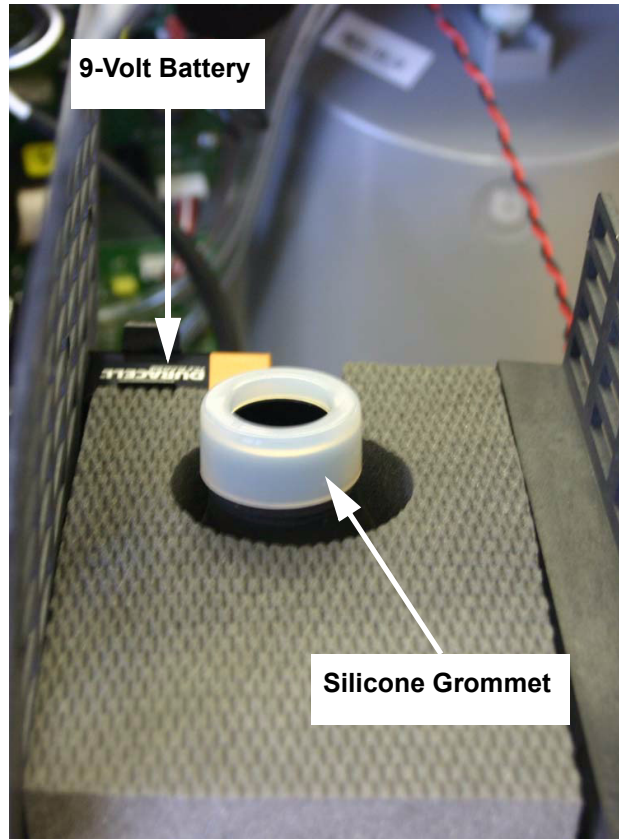
### To install the Perforated Canopy

1. While exerting slight inwards pressure on the sides of the Perforated Canopy, align the locating posts with the holes in the Compressor Cover.
2. Release the pressure, then ensure that the locating posts have locked in place in the Compressor Cover.
3. Slide the Front Cabinet onto the Base Cabinet.
4. Install the Rear Cabinet. Refer to the Rear Cabinet Replacement Section.

## COMPRESSOR COVER REPLACEMENT

### To remove the Compressor Cover

1. Remove the Rear Cabinet. Refer to the Rear Cabinet Replacement Section.
2. Slide the Front Cabinet forward until it is clear from the Base Cabinet.
3. Remove the filter configuration and Silicone grommet installed in the concentrator.

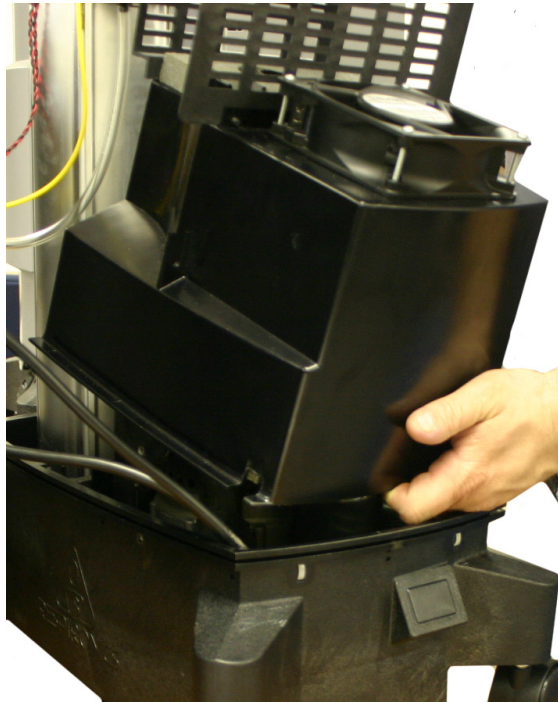


**FIGURE V: FILTERS REMOVED FROM SILICONE GROMMET AND 9-VOLT BATTERY LOCATION**

4. Remove the cooling fan. Refer to the Cooling Fan Replacement Section.
5. Remove the 9-volt battery.
6. Remove the Perforated Canopy. Refer to the Perforated Canopy Replacement Section.
7. Remove the two screws securing the Compressor Cover to the Base Cabinet.



8. Lift the Compressor Cover housing straight up and then away from the Base Cabinet.



**FIGURE W: REMOVAL OF THE COMPRESSOR COVER**

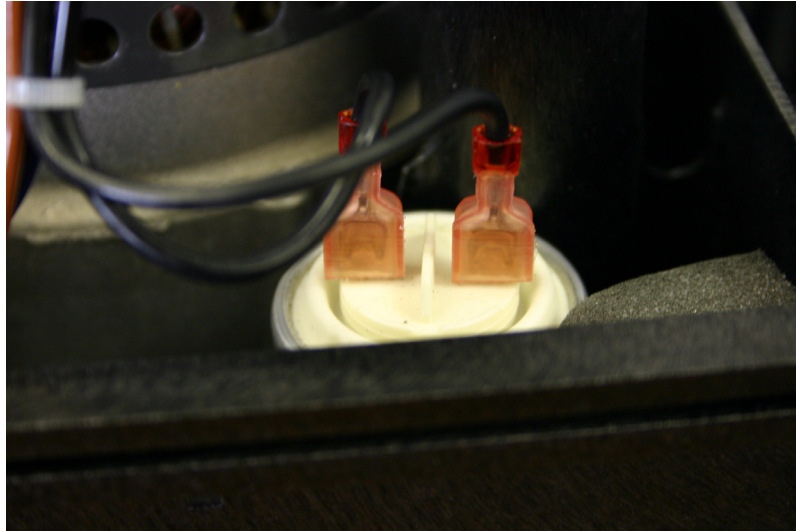
#### **To install the Compressor Cover**

1. Align the round hole in the top of the Compressor Cover housing with the inlet port of the Compressor assembly.
2. Set the Compressor Cover into place on the Base Cabinet. Ensure that the bottom of the Compressor Cover housing is correctly seated on the Base Cabinet.
3. Secure the Compressor Cover to the Base Cabinet with a phillips head screw on each side of the Compressor Cover.
4. Install the Perforated Canopy. Refer to the Perforated Canopy Replacement Section.
5. Install the cooling fan. Refer to the Cooling Fan Replacement Section.
6. Install the 9 volt battery.

## MOTOR START/RUN CAPACITOR REPLACEMENT

### To remove the Motor Start/Run Capacitor

1. Remove the Rear Cabinet. Refer to the Rear Cabinet Replacement Section.
2. Slide the Front Cabinet forward until it is clear from the Base Cabinet.
3. Remove the Compressor Cover. Refer to the Compressor Cover Replacement Section.
4. Using insulated needle-nose pliers, carefully remove the female connectors on the Capacitor wires from the two Capacitor terminals. For M10600/M10605 Enhanced units proceed to step 5. For M600/M605 Enhanced units proceed to step 6.



**FIGURE X: TERMINALS TO REMOVE FROM CAPACITOR**

### CAUTION

*Short the terminals of the Capacitor to discharge.*

5. Determine if the Capacitor is screwed into the Base Cabinet. If so, unscrew the Capacitor from the Base Cabinet.
6. After the Capacitor is discharged, lift the Capacitor up and out of the molded base.

### To install the Motor Start/Run Capacitor

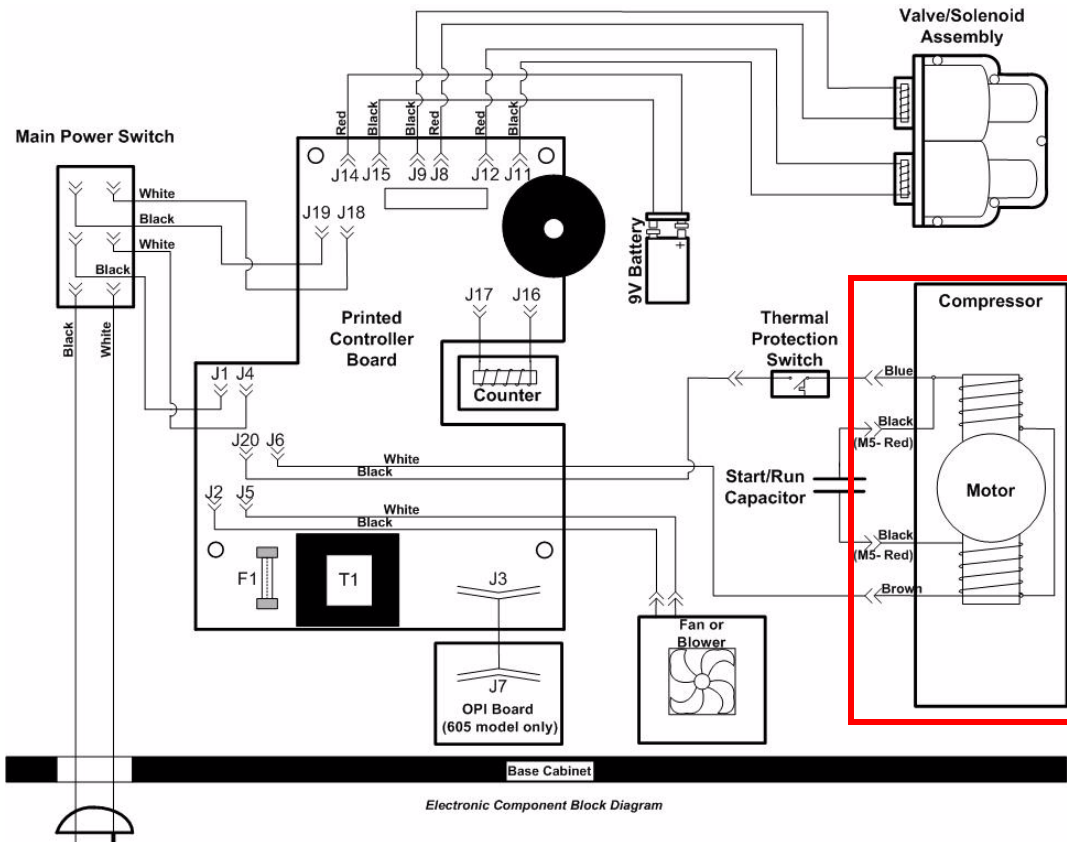
1. Slide the Capacitor into position between the foam insulation and the Compressor assembly standoff.
2. For M10600/M10605 Enhanced concentrators having a screw down Capacitor screw the Capacitor into the Base Cabinet.
3. Connect the Capacitor wires to the terminals on the Capacitor.
4. Make sure the Capacitor terminals are parallel to the rear wall in the Base Cabinet.

## COMPRESSOR ASSEMBLY REPLACEMENT

### WARNING

Ensure that the unit is disconnected from the AC power source before beginning this procedure.

### To remove the Compressor Assembly



**FIGURE Y: ELECTRONIC BLOCK DIAGRAM**

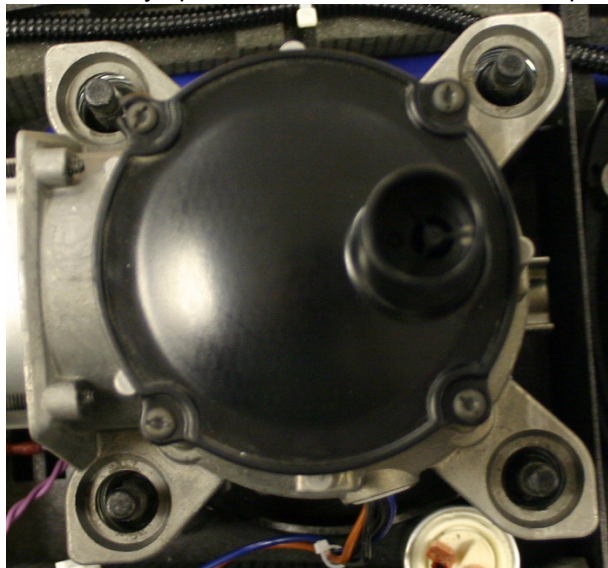
1. Remove the Rear Cabinet. Refer to the Rear Cabinet Replacement Section.
2. Slide the Front Cabinet forward until it is clear from the Base Cabinet.
3. Remove the Compressor Cover. Refer to the Compressor Cover Replacement Section.
4. Separate the connection where the brown wire from the Compressor and the white wire from the Main PCA meet. Refer to the block diagram in Figure Y.
5. Separate the connection where the blue wire from the thermal protection switch and the black wire from the Main PCA meet. Refer to the block diagram in Figure Y.

6. Disconnect the wires from the Capacitor terminals.

## NOTE

*The wires connected to the Capacitor are interchangeable.*

7. Using a crimping clamp tool or diagonals, cut the one-eared clamp securing the pressure tubing to the outlet port of the Compressor assembly. Remove the pressure tubing from the Compressor assembly outlet port.
8. For M10600/M10605 Enhanced Compressors mounted with 4 rubber bumpers, remove the 4 screws and bumpers securing Compressor to Base Cabinet. (If unit does not have 4 rubber bumpers then proceed to Step 9).
9. Lift the Compressor assembly up from the standoffs and helical springs.

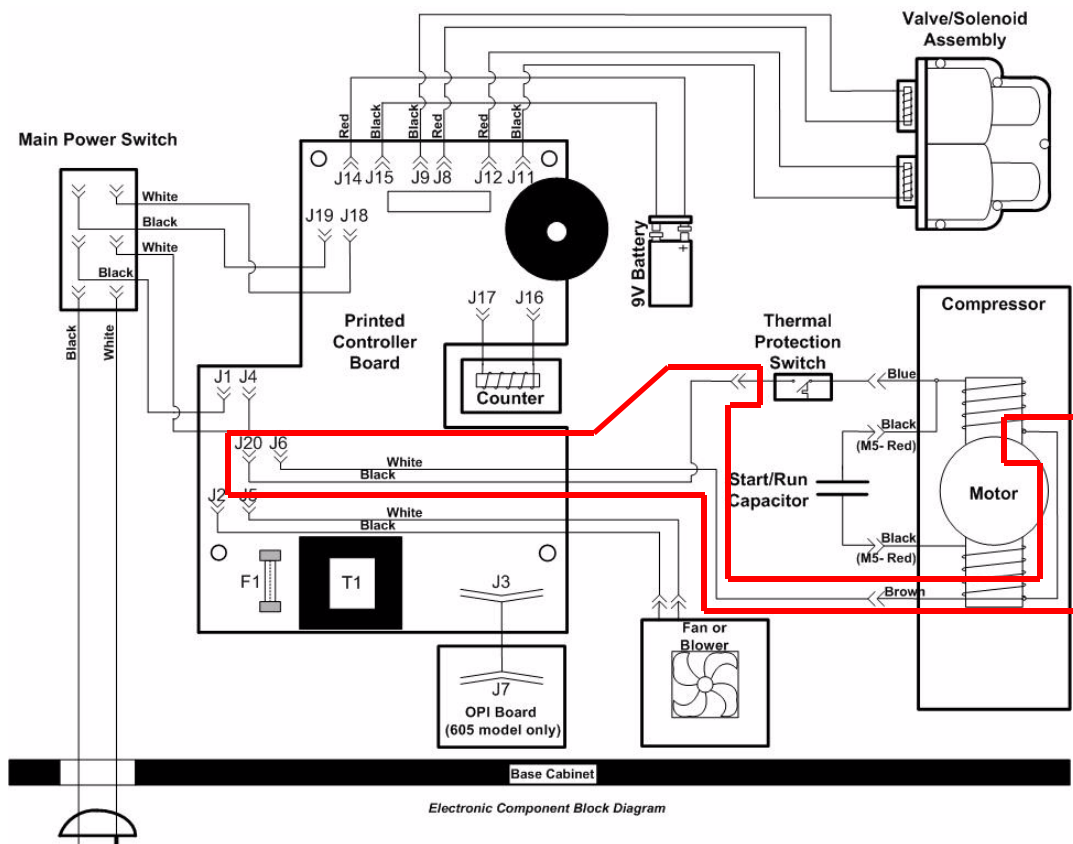


**FIGURE Z: TOP VIEW OF THE COMPRESSOR ON THE MOUNTING ROD AND SPRINGS**

**To install the Compressor Assembly**

1. Align the Compressor/motor assembly with the standoffs and helical springs. Set the Compressor assembly in place.
2. If M10600/M10605 Enhanced Compressor was mounted with 4 rubber bumpers, reinstall the 4 bumpers and 4 screws securing the Compressor to the Base Cabinet.
3. Slide the supplied one-eared clamp onto the pressure tubing. Align the tubing with the Compressor assembly outlet port. Slide the tubing onto the ports.
4. Slide the one-eared clamp into position on the pressure tubing. Using a crimping clamp tool or diagonals, firmly “pinch” the one-eared clamp to secure the pressure tubing.
5. Confirm that the In-line Muffler is not touching the side wall of the Base Cabinet
6. Install the Capacitor wire connectors onto the terminals of the Capacitor.
7. Push together the brown wire connector from the Compressor to the white wire connector from the Main PCB assembly. Press the connectors together until completely seated. Refer to the block diagram in Figure Y.
8. Push together the blue wire connector from the thermal protection switch to the black wire connector from the Main PCB assembly. Press the connectors together until completely seated. Refer to the block diagram in Figure Y.

## MAIN PCB TO COMPRESSOR WIRING REPLACEMENT



**FIGURE AA: ELECTRICAL BLOCK DIAGRAM**

### WARNING

*Make sure the AC power is disconnected.*

### To Remove the Main PCB to Compressor Wiring

1. Remove the Rear Cabinet. Refer to the Rear Cabinet Replacement Section.
2. Slide the Front Cabinet forward until it is clear from the Base Cabinet.
3. Remove the Compressor Cover. Refer to the Compressor Cover Replacement Section.
4. Remove the connectors on the Main PCB to Compressor wiring from terminals J6 and J20. Note the orientation of both the black and white wires on the Main PCB assembly. Refer to the block diagram in Figure AA.
5. Disconnect the black wire from the Main PCB to Compressor wiring from the blue wire coming from the thermal protection switch. Refer to the block diagram in Figure AA.
6. Disconnect the white wire from the Main PCB to Compressor wiring from the brown wire coming from the Compressor assembly. Refer to the block diagram in Figure AA.

**To Install the Main PCB to Compressor Wiring**

1. Connect the white wire from the Main PCB to Compressor wiring harness to the brown wire coming from the Compressor. Ensure that the wire connectors are fully seated. Refer to the block diagram in Figure AA.
2. Connect the black wire from the Main PCB to Compressor wire harness to the blue wire coming from the thermal protection switch. Ensure that the wire connectors are fully seated. Refer to the block diagram in Figure AA.
3. Connect the white wire from the Main PCB to Compressor wire harness to terminal J6 on the Main PCB assembly. Ensure that the wire connectors are fully seated. Refer to the block diagram in Figure AA.
4. Connect the black wire from the Main PCB to Compressor wire harness to terminal J20 on the Main PCB assembly. Ensure that the wire connectors are fully seated. Refer to the block diagram in Figure AA.

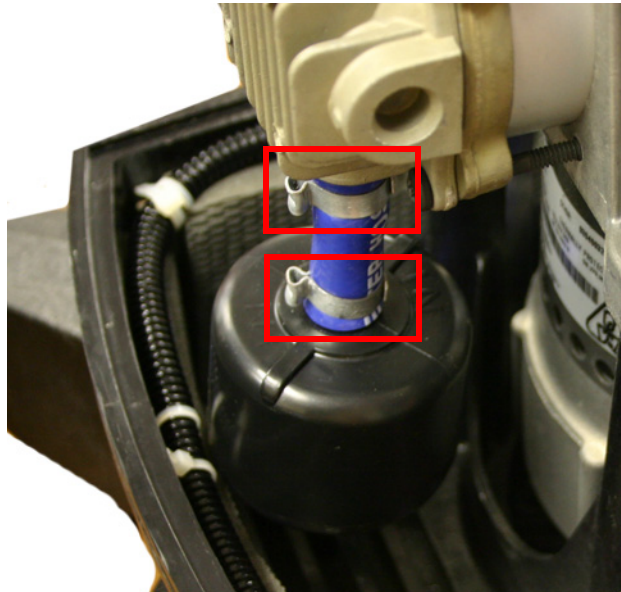




## IN-LINE MUFFLER REPLACEMENT

### To remove the In-line Muffler

1. Remove the Rear Cabinet. Refer to the Rear Cabinet Replacement Section.
2. Slide the Front Cabinet forward until it is clear from the Base Cabinet.
3. Remove the Compressor Cover. Refer to the Compressor Cover Replacement Section.
4. Using a crimping clamp tool or diagonals, cut the two one-eared clamps between the Compressor head and In-line Muffler.
5. Straighten the pressure hose to gain access to the bottom on the In-line Muffler. Cut the one-eared clamp then remove the pressure hose.



**FIGURE AC: LOCATION OF THE ONE-EARED CLAMPS**

6. Remove the In-line Muffler.

## To install the In-line Muffler

1. Slide a new one-eared clamp onto the existing 12" pressure hose. Attach the pressure hose to the bottom In-line Muffler.

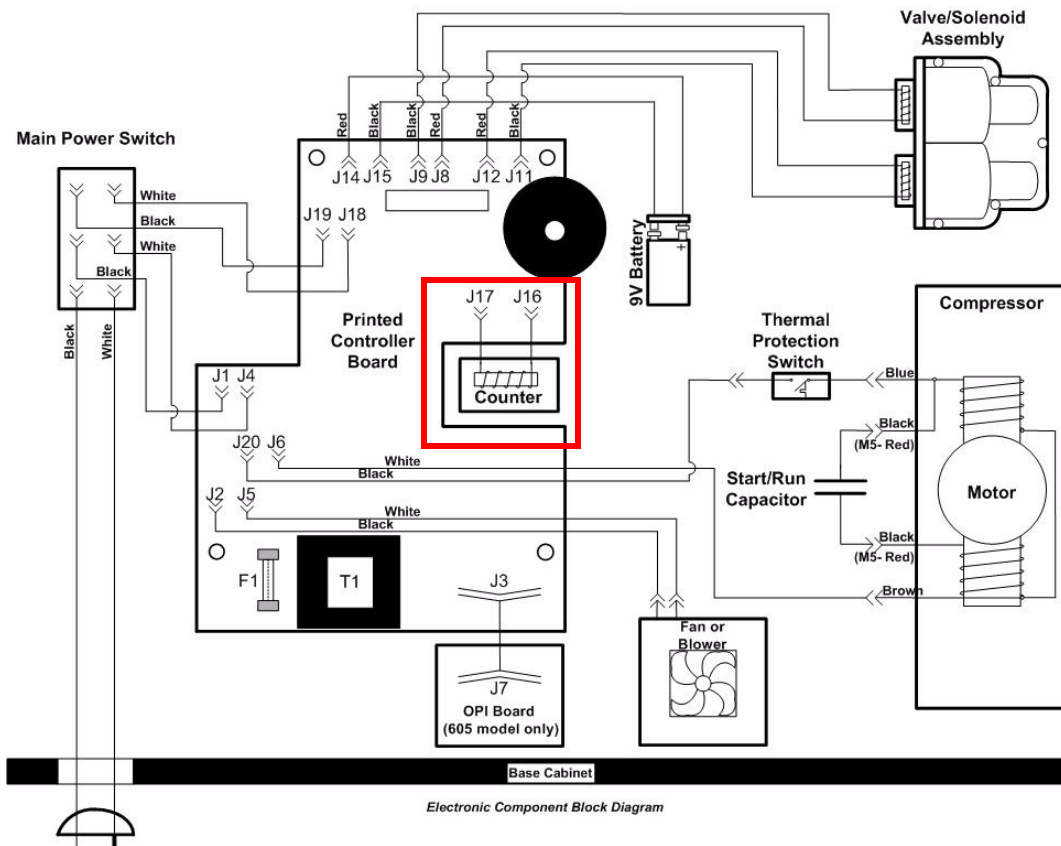


**FIGURE AD: CONNECTING PRESSURE TO IN-LINE MUFFLER**

2. Using a crimping tool or diagonals, firmly "pinch" the one-eared clamp to securely fasten the pressure tubing to the outlet port of the In-line Muffler.
3. Attach the 1 3/4" pressure hose to the inlet port of the In-line Muffler. Slide a new one-eared clamp onto pressure tubing.
4. Using a crimping tool or diagonals, firmly "pinch" the one-eared clamp to securely fasten the pressure tubing to the inlet port of the In-line Muffler.
5. Slide a one-eared clamp over the 1 3/4" pressure hose.
6. Align then seat the short pressure tubing on the Compressor assembly's outlet port.
7. Using a crimping tool or diagonals, firmly "pinch" the one-eared clamp to secure the connections at the Compressor assembly.

## HOURLY METER REPLACEMENT

To remove the Hour Meter



**FIGURE AE: ELECTRONIC BLOCK DIAGRAM**

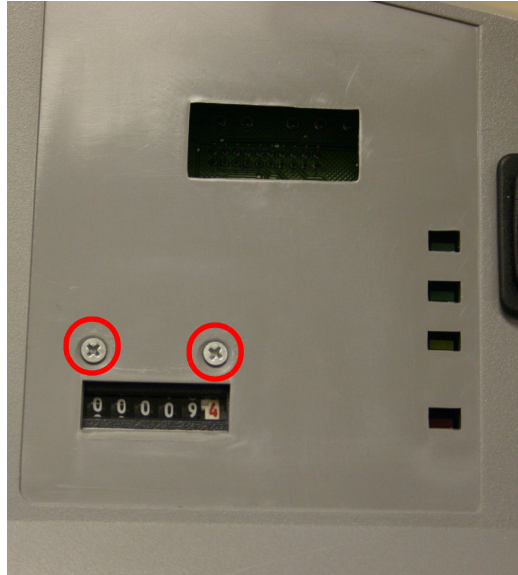
1. Remove the Rear Cabinet. Refer to the Rear Cabinet Replacement Section.
2. Slide the Front Cabinet forward until it is clear from the Base Cabinet.
3. Using your fingers or needle-nose pliers, remove the wires from terminals J16 and J17 on the Main PCB assembly. Refer to the block diagram in Figure AE.

### NOTE

*The Hour Meter wires are interchangeable.*

4. Starting at one corner, carefully peel the Overlay off of the cabinet. Refer to Overlay Replacement Section.

5. Remove the two small screws which secure the Hour Meter.



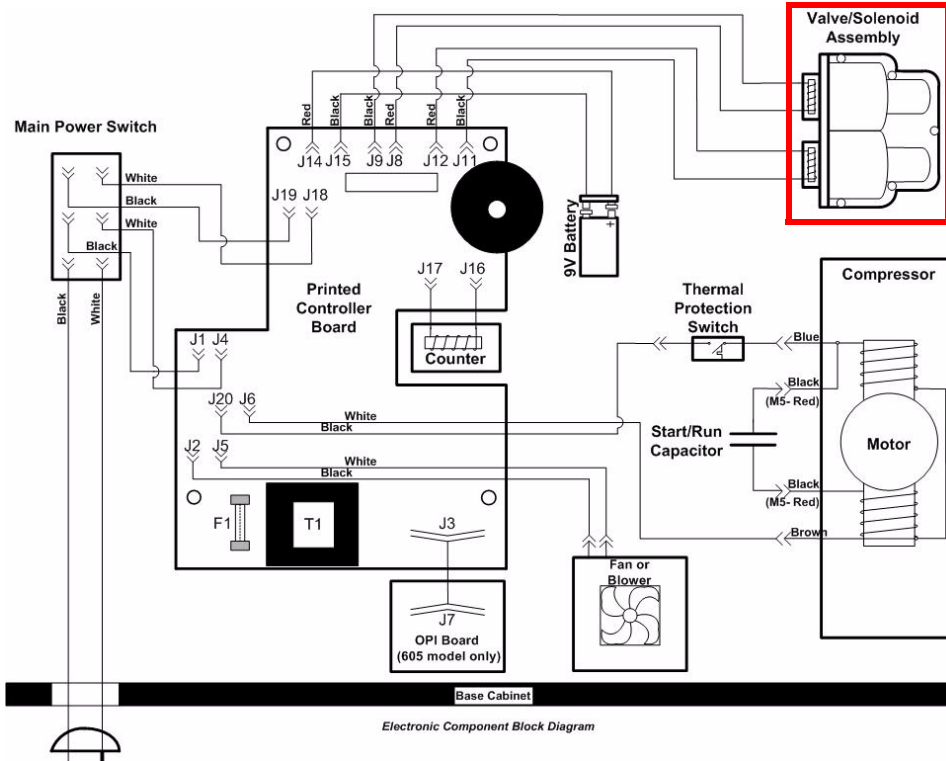
**FIGURE AF: SCREW LOCATIONS**

6. Remove the Hour Meter from the Front Cabinet.

**To install the Hour Meter**

1. Install the Hour Meter into the Front Cabinet. Hand tighten the two small screws which secure the Hour Meter.
2. Connect the wires from the Hour Meter to terminals J16 and J17 on the Main PCB assembly. Ensure that the wires are fully seated on the Main PCB assembly. Refer to the block diagram in Figure AE.
3. If Overlay was not damaged when removed, install Overlay onto cabinet. If Overlay was damaged during removal then install new Overlay onto Front Cabinet.

## VALVE/SOLENOID REPLACEMENT

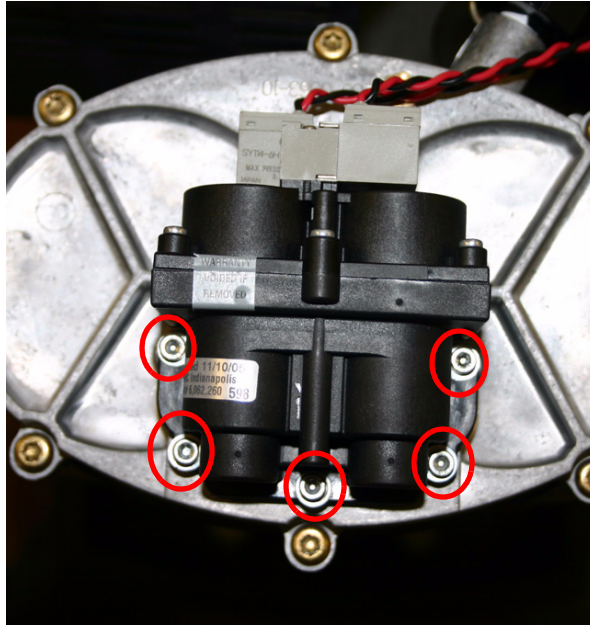


**FIGURE AG: ELECTRONIC BLOCK DIAGRAM**

### To remove the Valve/Solenoid

1. Remove the Rear Cabinet. Refer to the Rear Cabinet Replacement Section.
2. Slide the Front Cabinet forward until it is clear from the Base Cabinet.
3. Remove the wire connectors from terminals J8, J9, J11, and J12 on the Main PCB assembly. Refer to the block diagram in Figure AG.

- Using a 7/64" hex key wrench or socket, remove the five screws and flat washers securing the Valve/Solenoid to the top of the Sieve Canister Assembly.



**FIGURE AH: SCREW LOCATIONS**

- Lift the Valve/Solenoid Assembly and wiring harnesses up and away from the Sieve Canister Assembly.



**FIGURE AI: REMOVAL OF THE VALVE/SOLENOID**

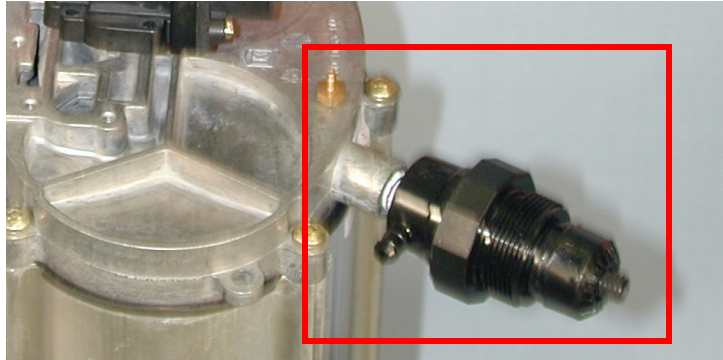
**To install the Valve/Solenoid Assembly**

1. Align the Valve/Solenoid Assembly with the holes in the top of the Sieve Canister Assembly.
2. Using the five screws and flat washers provided, secure the Valve/Solenoid Assembly to the Sieve Canister Assembly. The screws should be torqued sufficiently in order to prevent leaks, but care should be taken not to crush the shoulder of the valve.
3. Reconnect the wire connectors to terminals J8, J9, J11, and J12 on the Main PCB assembly. Refer to the block diagram in Figure AG.
4. Connect the unit to a power source and turn on the device. Apply snoop leak detector to the area where the Valve/Solenoid Assembly mounts to the Sieve Canister Assembly and check for leaks.

## PRESSURE REGULATOR REPLACEMENT

### To remove the Pressure Regulator

1. Remove the Rear Cabinet. Refer to the Rear Cabinet Replacement Section.
2. Slide the Front Cabinet forward until it is clear from the Base Cabinet.
3. Remove the pressure tubing from the outlet port on the pressure regulator.
4. Note the orientation of the pressure regulator outlet port. The new pressure regulator must be installed with the outlet port in the same position.



**FIGURE AJ: ORIENTATION OF THE PRESSURE REGULATOR**

5. Using a pair of channel locks, remove the pressure regulator from the Sieve Canister Assembly.



**FIGURE AK: REMOVAL OF THE PRESSURE REGULATOR**



**To install the Pressure Regulator**

1. Apply a layer of Teflon thread tape to the threads of the pressure regulator.

**CAUTION**

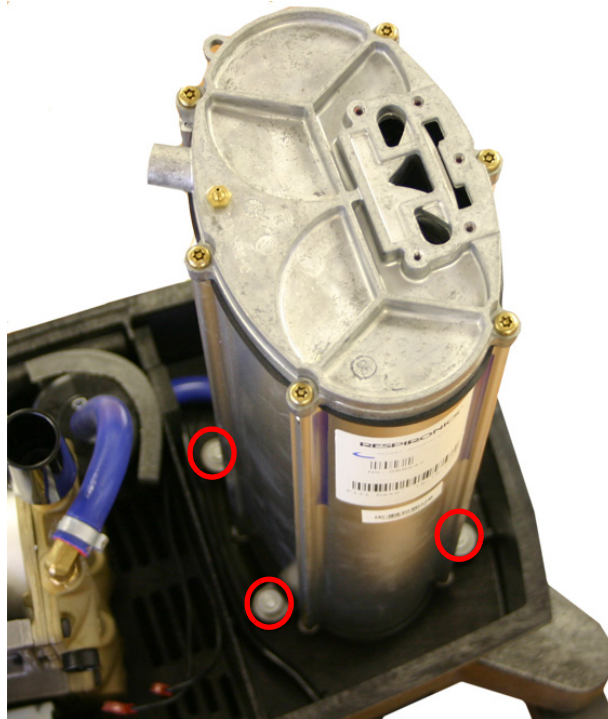
*The tape should be installed in a counter clockwise direction, with the Pressure Regulator threads facing you.*

2. Align the pressure regulator with the pressure regulator port in the Sieve Canister Assembly. Screw the pressure regulator into the Sieve Canister Assembly until strong resistance is felt and the pressure regulator outlet port is oriented in the correct position.
3. Install the pressure tubing on the pressure regulator outlet port.
4. Connect the unit to a power source and turn on the unit. Apply snoop leak detector to the area where the pressure regulator mounts to the Sieve Canister Assembly and where the O<sub>2</sub> tubing connects to the outlet barb to check for leaks.

## SIEVE CANISTER ASSEMBLY REPLACEMENT

### To remove the Sieve Canister Assembly

1. Remove the Rear Cabinet. Refer to the Rear Cabinet Replacement Section.
2. Slide the Front Cabinet forward until it is clear from the Base Cabinet.
3. Remove the Compressor Cover. Refer to the Compressor Cover Replacement Section.
4. Remove the Valve/Solenoid Assembly. Refer to the Valve/Solenoid Replacement Section.
5. Remove the pressure regulator. Refer to the Pressure Regulator Replacement Section.
6. Using the 5/16" Nut Driver (Supplied in RI p/n H647, Millennium Tool Kit), remove the four screws securing the Sieve Canister Assembly to the Base Cabinet.



**FIGURE A1: LOCATION OF MOUNTING SCREWS (3 OF 4 SHOWN)**

7. Using a crimping clamp tool or diagonals, cut the one-eared clamp securing the 12" pressure tubing to the inlet port of the Sieve Canister.
8. Remove the 12" pressure tubing from the inlet port of the Sieve Canister.
9. Lift the Sieve Canister Assembly up and out of the Base Cabinet.
10. Remove the Blow Down Muffler from the Sieve Canister Assembly. Refer to the Blow Down Muffler Replacement Section.
11. Remove the brass fitting from the top of the Sieve Canister Assembly.

**To install the Sieve Canister Assembly**

1. Install the supplied canister foam on the bottom of the Sieve Canister Assembly.
2. Install the brass fitting in the top of the Sieve Canister Assembly.
3. Install the Blow Down Muffler onto the Sieve Canister Assembly. Refer to the Blow Down Muffler Replacement Section.
4. Set the Sieve Canister Assembly in place in the Base Cabinet.

**NOTE**

*Ensure that the AC Power Cord is clear of the Sieve Canister Assembly.*

5. Slide the one-eared clamp provided onto the 12" pressure tubing.
6. Install the 12" pressure tubing provided on the inlet port of the Sieve Canister.
7. Using a crimping clamp tool or diagonals, "pinch" the one-eared clamp securing the pressure tubing to the inlet port of the Sieve Canister Assembly.
8. Using the 5/16" Nut Driver, insert then tighten the four screws that secure the Sieve Canister Assembly to the molded base.
9. Install the pressure regulator. Refer to the Pressure Regulator Replacement Section.
10. Install the Valve/Solenoid on the top of the Sieve Canister. Refer to the Valve/Solenoid Replacement Section.
11. Install the wire connectors on the terminals of the valve/solenoid.
12. Connect the yellow pressure tubing to the brass fitting on the top of the Sieve Canister.
13. Connect the clear pressure tubing to the port on the pressure regulator.
14. Install the Compressor Cover. Refer to the Compressor Cover Replacement Section.

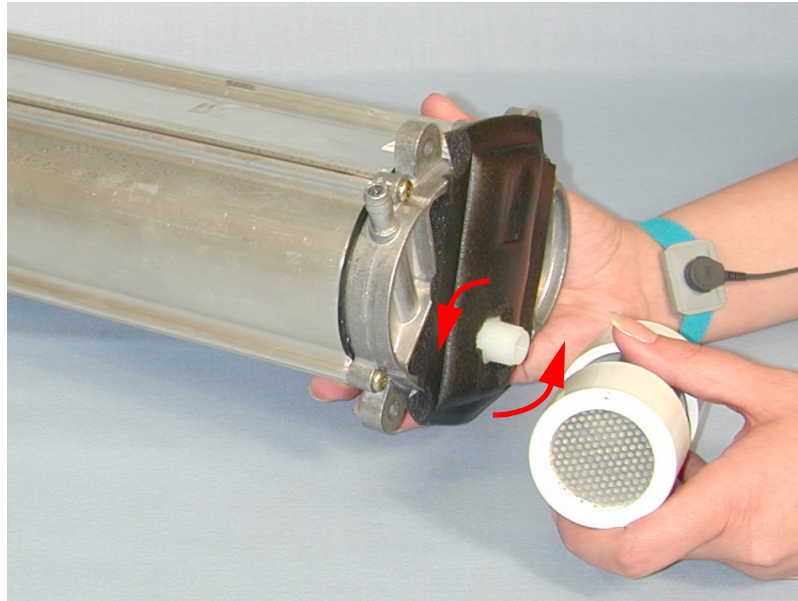
## BLOW DOWN MUFFLER REPLACEMENT

### NOTE

*If care is taken during the following procedures, the Valve/Solenoid Assembly and the pressure regulator do not have to be removed. However, if these components are damaged during the procedure, they must be replaced.*

#### To remove the Blow Down Muffler

1. Remove the Rear Cabinet. Refer to the Rear Cabinet Replacement Section.
2. Slide the Front Cabinet forward until it is clear from the Base Cabinet.
3. Remove the Compressor Cover. Refer to the Compressor Cover Replacement Section.
4. Remove the Valve/Solenoid Assembly. Refer to the Valve/Solenoid Replacement Section.
5. Remove the Pressure Regulator. Refer to the Pressure Regulator Replacement Section.
6. Remove the Sieve Canister Assembly.
7. Note the orientation of the blown down muffler in relation to the Sieve Canister Assembly.
8. Using channel locks, turn the Blow Down Muffler counter-clockwise until it is free of the sieve canister assembly.



**FIGURE AM: REMOVING THE BLOW DOWN MUFFLER**

### To install the Blow Down Muffler

1. Align the Blow Down Muffler with the Sieve Canister Assembly's threaded fitting. Screw the Blow Down Muffler onto the fitting until it comes in contact with the Sieve Canister foam and the Blow Down Muffler is positioned in its original orientation.
2. Set the Sieve Canister Assembly in place in the Base Cabinet.

#### NOTE

*Ensure that the AC Power Cord is clear of the Sieve Canister Assembly.*

3. Slide the one-eared clamp provided onto the 12" pressure tubing.
4. Install the 12" pressure tubing provided on the inlet port of the Sieve Canister.
5. Using a crimping clamp tool or diagonals, "pinch" the one-eared clamp securing the pressure tubing to the inlet port of the Sieve Canister Assembly.
6. Using the 5/16" Nut Driver, insert then tighten the four screws that secure the Sieve Canister Assembly to the molded base.
7. Install the Valve/Solenoid on the top of the Sieve Canister. Refer to the Valve/Solenoid Replacement Section.
8. Install the wire connectors on the terminals of the valve/solenoid.
9. Connect the yellow pressure tubing to the brass fitting on the top of the Sieve Canister.
10. Connect the clear pressure tubing to the port on the pressure regulator.
11. Install the pressure regulator (if removed). Refer to the Pressure Regulator Replacement Section.
12. Install the Valve/Solenoid Assembly (if removed). Refer to the Valve/Solenoid Replacement Section.
13. Install the Compressor Cover. Refer to the Compressor Cover Replacement Section.

## POWER CORD REPLACEMENT

### To remove the Power Cord

1. Remove the Rear Cabinet. Refer to the Rear Cabinet Replacement Section.
2. Slide the Front Cabinet forward until it is clear from the Base Cabinet.
3. Remove the Compressor Cover. Refer to the Compressor Cover Replacement Section.
4. Remove the Power Cord Connection from the Main Power Switch.
5. Using a Heyco tool, depress the locking tabs on the AC Power Cord strain relief grommet installed in the Base Cabinet.
6. Once the grommet is free of the Base Cabinet, remove the Power Cord.

### To install the Power Cord

1. Insert the Power Cord wires into the hole in the Base Cabinet.
2. Route the Power Cord wires up to the Main Power Switch.
3. Align the black and white Power Cord wires with their receptacles on the Main Power Switch.

### CAUTION

*The black and white Power Cord wires MUST be inserted in the main power wiring harness connector in their original configuration (black wire on left and white wire on right). If they are reversed, damage to the unit will occur.*

4. Align the Power Cord strain relief grommet with the cutout in the Base Cabinet. Press the grommet into the Base Cabinet until completely seated.
5. Install the Compressor Cover. Refer to the Compressor Cover Replacement Section.
6. Slide the Front Cabinet onto the Base Cabinet.
7. Install the Rear Cabinet. Refer to the Rear Cabinet Replacement Section.

---

## BASE CABINET REPLACEMENT

### NOTE

*If care is taken during the following procedures, the Valve/Solenoid Assembly and the pressure regulator do not have to be removed. However, if these components are damaged during the procedure, they must be replaced.*

#### Removing the Base Cabinet

1. Remove the Rear Cabinet. Refer to the Rear Cabinet Replacement Section.
2. Slide the Front Cabinet forward until it is clear from the Base Cabinet.
3. Remove Compressor Cover/Perforated Canopy. Refer to the Compressor Cover Replacement Section.
4. Remove Capacitor. Refer to the Motor Start/Run Capacitor Replacement Section.
5. Remove Compressor Assembly. Refer to the Compressor Assembly Replacement Section.
6. Remove In-line Muffler. Refer to the In-line Muffler Replacement Section.
7. Remove Hour Meter. Refer to the Hour Meter Replacement Section.
8. Remove Sieve Canister Assembly. Refer to the Sieve Canister Assembly Replacement Section.
9. Remove Power Cord. Refer to the Power Cord Replacement Section.
10. Remove Base Cabinet and bottom pan.

#### Installing the Base Cabinet

1. All components have now been removed from the original Base Cabinet. To begin reassembly, place the Base Cabinet on a protected work surface. Follow the disassembly process in reverse order to reassemble the unit.



---

## REPAIR KITS

### SECTION OVERVIEW

This chapter illustrates the names and components for each of the repair kits for the Millennium Oxygen Concentrators.

For technical assistance or replacement part ordering information, contact Respironics Product Support.

#### **USA and Canada**

Phone: 1-800-345-6443

Fax: 1-800-866-0245

Email: [service@respironics.com](mailto:service@respironics.com)

#### **International**

Phone: 1-724-387-4000

Fax: 1-800-387-5012

**Visit Respironics Home Page on the World Wide Web at:**

**[www.respironics.com](http://www.respironics.com)**





**QUICK REFERENCE TABLE**


<b>KIT NAME</b>	<b>PAGE IDENTIFIER</b>
<i>230V AC Inlet Fuse Kit</i>	<i>Page 6</i>
<i>230V Fuse Holder Kit</i>	<i>Page 6</i>
<i>AC Inlet Kit</i>	<i>Page 5</i>
<i>Air Inlet Filter Kits</i>	<i>Page 21</i>
<i>Alarm Battery Kit</i>	<i>Page 5</i>
<i>Base Cabinet Kits</i>	<i>Page 7</i>
<i>Base Pan Kit</i>	<i>Page 8</i>
<i>Blow Down Muffler Kits</i>	<i>Page 8</i>
<i>Blower Assembly Replacement 50 HZ Kit</i>	<i>Page 9</i>
<i>Cabinet Hardware Kit</i>	<i>Page 9</i>
<i>Cable Tie (Screw Down) Kit</i>	<i>Page 9</i>
<i>Capacitor Kits</i>	<i>Page 10</i>
<i>Caster Kits</i>	<i>Page 11</i>
<i>Compressor Bracket Kit</i>	<i>Page 17</i>
<i>Compressor Cover/Perforated Canopy Kits</i>	<i>Page 18</i>
<i>Compressor Elbow Fitting Kit</i>	<i>Page 13</i>
<i>Compressor Inlet Adaptor Kit</i>	<i>Page 13</i>
<i>Compressor Kits</i>	<i>Page 12</i>
<i>Compressor Maintenance Kits</i>	<i>Page 15</i>
<i>Compressor Mounting Kits</i>	<i>Page 16</i>
<i>Compressor Spring Kit</i>	<i>Page 18</i>
<i>Cooling Fan Kits</i>	<i>Page 20</i>
<i>DISS Outlet Fitting Kit</i>	<i>Page 20</i>
<i>Elbow/Hose Kit</i>	<i>Page 20</i>
<i>Felt Filter Kit</i>	<i>Page 25</i>
<i>Filter Cover Kit</i>	<i>Page 25</i>
<i>Flow Meter Kits</i>	<i>Page 26</i>
<i>Flow Meter Knob Kit</i>	<i>Page 27</i>


<b>KIT NAME</b>	<b>PAGE IDENTIFIER</b>
<i>Foam Kit</i>	<i>Page 28</i>
<i>Front Cabinet Kits</i>	<i>Page 29</i>
<i>Gasket Kits</i>	<i>Page 30</i>
<i>Hour Meter Kits</i>	<i>Page 31</i>
<i>Inlet Filter Kits</i>	<i>Page 22</i>
<i>In-line Muffler Kits</i>	<i>Page 32</i>
<i>Long Life Filter Kits</i>	<i>Page 21</i>
<i>Long Life Filter Retrofit Kit</i>	<i>Page 21</i>
<i>Main PCA Fuse Kits</i>	<i>Page 30</i>
<i>Main PCA Kits</i>	<i>Page 39</i>
<i>Main PCB to Battery Cable Wiring Kit</i>	<i>Page 49</i>
<i>Main PCB to Compressor Cable Wiring Kit</i>	<i>Page 49</i>
<i>Main PCB to Fan Cable Wiring Kit</i>	<i>Page 48</i>
<i>Main Power Wiring Harness Kits</i>	<i>Page 46</i>
<i>Micro-disk Filter Kit</i>	<i>Page 24</i>
<i>O2/Solenoid/Battery Wiring Harness Kit</i>	<i>Page 47</i>
<i>One-eared Clamp Kit</i>	<i>Page 42</i>
<i>OPI PCB Kit</i>	<i>Page 33</i>
<i>OPI Wiring Harness Kit</i>	<i>Page 47</i>
<i>OPI/O2/Solenoid/Battery Wiring Harness Kit</i>	<i>Page 47</i>
<i>Overly Kits</i>	<i>Page 34</i>
<i>Perforated Canopy Kit</i>	<i>Page 37</i>
<i>Power Cord Kit</i>	<i>Page 40</i>
<i>Power Cord Retainer Kit</i>	<i>Page 5</i>
<i>Power Switch Kits</i>	<i>Page 37</i>
<i>Power Switch Wiring Harness Kit</i>	<i>Page 48</i>
<i>Pre-inlet Filter Kits</i>	<i>Page 24</i>
<i>Pressure Regulator Kit</i>	<i>Page 38</i>
<i>Pressure Relief Valve Kit</i>	<i>Page 38</i>
<i>Rear Access Door Kits</i>	<i>Page 40</i>


<b>KIT NAME</b>	<b>PAGE IDENTIFIER</b>
<i>Rear Cabinet Kits</i>	<i>Page 41</i>
<i>Retainer Air Intake Kit</i>	<i>Page 25</i>
<i>Retainer Inlet Filter Kits</i>	<i>Page 24</i>
<i>Serial Number Plate Kits</i>	<i>Page 42</i>
<i>Shipping Carton Insert Kits</i>	<i>Page 44</i>
<i>Shipping Carton Kits</i>	<i>Page 43</i>
<i>Sieve Canister Kits</i>	<i>Page 43</i>
<i>Silencer Kits</i>	<i>Page 23</i>
<i>Silicone Grommet Kit</i>	<i>Page 22</i>
<i>Single Port to Four Port Compressor Conversion Kit</i>	<i>Page 13</i>
<i>Solenoid Gasket Kit</i>	<i>Page 46</i>
<i>Spare Gasket &amp; Seal Kit</i>	<i>Page 14</i>
<i>Spare Piston Cup Seal Kit</i>	<i>Page 14</i>
<i>Spare Plate, Valve, Flapper Kit</i>	<i>Page 14</i>
<i>Stand Alone Pediatric Flow Meter Kit</i>	<i>Page 27</i>
<i>Thermal Protection Switch Kit</i>	<i>Page 48</i>
<i>Tubing Kit</i>	<i>Page 44</i>
<i>Valve/Solenoid Kits</i>	<i>Page 45</i>
<i>Warning/Instruction Label Kits</i>	<i>Page 36</i>
<i>Whisper Cap Kits</i>	<i>Page 22</i>

<b>ALARM BATTERY KIT</b>		
<b>Concentrator Model #</b>	<b>Kit #</b>	<b>Included in Kit</b>
<ul style="list-style-type: none"> <li>• <i>All Millennium Concentrators</i></li> </ul>	<p style="text-align: center;">130-0009-00</p>	<ul style="list-style-type: none"> <li>• <i>9-volt Alarm Battery</i></li> </ul> <div style="text-align: center;">  </div>


<b>AC INLET KIT</b>		
<b>Concentrator Model #</b>	<b>Kit #</b>	<b>Included in Kit</b>
<ul style="list-style-type: none"> <li>• <i>All 230V Models (except M600-50 and M605-50)</i></li> </ul>	<p style="text-align: center;">192-0008-00</p>	<ul style="list-style-type: none"> <li>• <i>AC Inlet</i></li> </ul> <div style="text-align: center;">  </div>


<b>POWER CORD RETAINER KIT</b>		
<b>Concentrator Model #</b>	<b>Kit #</b>	<b>Included in Kit</b>
<ul style="list-style-type: none"> <li>• <i>H600/H605 230V Concentrators</i></li> <li>• <i>M600/M605 230V Concentrators (except models M600-50 and M605-50)</i></li> </ul>	<p style="text-align: center;">260-0523-00</p>	<ul style="list-style-type: none"> <li>• <i>Power Cord Retainer</i></li> </ul> <div style="text-align: center;">  </div>


<b>230V AC INLET FUSE KIT</b>		
<b>Concentrator Model #</b>	<b>Kit #</b>	<b>Included in Kit</b>
<ul style="list-style-type: none"> <li>• <i>All 230V Concentrators</i></li> </ul>	1006513	<ul style="list-style-type: none"> <li>• <i>Fuse, 4.0 A SLO-BLO (x10)</i></li> </ul> <div style="text-align: center;">  </div>

<b>230V FUSE HOLDER KIT</b>		
<b>Concentrator Model #</b>	<b>Kit #</b>	<b>Included in Kit</b>
<ul style="list-style-type: none"> <li>• <i>All 230V Concentrators</i></li> </ul>	1007742	<ul style="list-style-type: none"> <li>• <i>Fuse Holder</i></li> </ul> <div style="text-align: center;">  </div>

<b>BASE CABINET KITS</b>		
<b>Concentrator Model #</b>	<b>Kit #</b>	<b>Included in Kit</b>
• H600/H605 120V	H636	<ul style="list-style-type: none"> <li>• Base Cabinet</li> <li>• Base Cabinet foam Assembly</li> <li>• Base Cabinet foam, Compressor</li> <li>• Base Cabinet foam, hose port</li> <li>• Base Cabinet pan</li> <li>• Base Cabinet pan foam</li> <li>• Caster (x4)</li> <li>• #6-18 x 1/2" Pan Head Phillips Self Taping screw (x6)</li> <li>• Cable tie (x10)</li> <li>• Screw M6 x 2.69 x 40 MM, Plasti KW (x4)</li> <li>• Fuse Holder (Kit's 1006494 &amp; 1017602 ONLY)</li> </ul>
• H600/H605 230V	1006494	
• M600/M605**	1015584	
• M600/M605 230V (except M600-50/M605-50)	1017601	
• M600-50/M605-50	1017602	
• M600/M605 120V • M10600/M10605	1018250	
• Enhanced M600/M605 120V	1023800	
• Enhanced M10600/M10605	1023801	
• Enhanced M600-10 • Enhanced M600-16 • Enhanced M600-20 • Enhanced M600-30 • Enhanced M600-40 • Enhanced M605-10 • Enhanced M605-16 • Enhanced M605-20 • Enhanced M605-30 • Enhanced M605-40 • Enhanced M605-70	1023802	
• Enhanced M600-50/M605-50	1023803	
<p>** This part is to be used if replacing the green rigid base of the old H600/H605 models.</p>		

<b>BASE PAN KIT</b>		
<b>Concentrator Model #</b>	<b>Kit #</b>	<b>Included in Kit</b>
<ul style="list-style-type: none"> <li>• <i>All Millennium Concentrators</i></li> </ul>	H642	<ul style="list-style-type: none"> <li>• <i>Base Pan</i></li> <li>• <i>#6-18 x 1/2" Pan Head Phillips Screws (x6)</i></li> </ul> <div style="text-align: center;">  </div>




<b>BLOW DOWN MUFFLER KITS</b>		
<b>Concentrator Model #</b>	<b>Kit #</b>	<b>Included in Kit</b>
<ul style="list-style-type: none"> <li>• <i>All Millennium Concentrators</i></li> </ul>	1006704	<ul style="list-style-type: none"> <li>• <i>Blow Down Muffler Assembly</i></li> <li>• <i>3/8" Nylon Fitting</i></li> </ul>
<ul style="list-style-type: none"> <li>• <i>M600/M605 Concentrators</i></li> <li>• <i>Enhanced M600/605 Concentrators</i></li> <li>• <i>M10600/M10605 Concentrators</i></li> <li>• <i>Enhanced M10600/M10605 Concentrators</i></li> </ul>	260-0805-10	<ul style="list-style-type: none"> <li>• <i>Blow Down Muffler Only</i></li> </ul> <div style="text-align: center;">  </div>
<ul style="list-style-type: none"> <li>• <i>H600/605 230V Concentrators</i></li> </ul>	260-0805-20	<ul style="list-style-type: none"> <li>• <i>Blow Down Muffler Only</i></li> </ul>


<b>BLOWER ASSEMBLY REPLACEMENT 50 HZ KIT</b>		
<b>Concentrator Model #</b>	<b>Kit #</b>	<b>Included in Kit</b>
<ul style="list-style-type: none"> <li>• <i>All 230V Millennium Concentrators</i></li> </ul>	1006497	<ul style="list-style-type: none"> <li>• <i>50 HZ Compressor Cover Assembly with Blower</i></li> </ul> <div style="text-align: center; margin-top: 10px;">  </div>

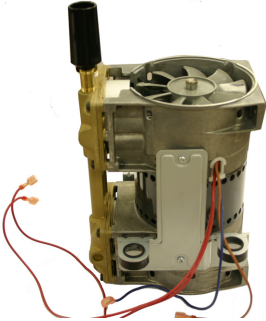
<b>CABLE TIE (SCREW DOWN) KIT</b>		
<b>Concentrator Model #</b>	<b>Kit #</b>	<b>Included in Kit</b>
<ul style="list-style-type: none"> <li>• <i>All Millennium Concentrators</i></li> </ul>	H641	<ul style="list-style-type: none"> <li>• <i>Cable Ties (x10)</i></li> </ul>

<b>CABINET HARDWARE KIT</b>		
<b>Concentrator Model #</b>	<b>Kit #</b>	<b>Included in Kit</b>
<ul style="list-style-type: none"> <li>• <i>M600/M605 Concentrators</i></li> <li>• <i>Enhanced M600/M605 Concentrators</i></li> <li>• <i>M10600/M10605 Concentrators</i></li> <li>• <i>Enhanced M10600/M10605 Concentrators</i></li> </ul>	1015605	<ul style="list-style-type: none"> <li>• <i>Screw 10-32 x 0.75" Phillips Head, Black (x20)</i></li> <li>• <i>Screw 10-32 x 0.5" Phillips Head, Black (x10)</i></li> <li>• <i>Nut 10-32 Hex, Steel (x30)</i></li> </ul>





<b>CAPACITOR KITS</b>		
<b>Concentrator Model #</b>	<b>Kit #</b>	<b>Included in Kit</b>
<ul style="list-style-type: none"> <li>• <i>H600/H605 Concentrators</i></li> <li>• <i>M600/M605 120V Concentrators</i></li> <li>• <i>Enhanced M600/M605 120V Concentrators</i></li> </ul>	H180-1502-25	<ul style="list-style-type: none"> <li>• <i>Capacitor 15 uf (metal can) only</i></li> </ul> 
<ul style="list-style-type: none"> <li>• <i>All Millennium M10600/M10605 Concentrators</i></li> </ul>	1014671	<ul style="list-style-type: none"> <li>• <i>Capacitor 25 uf (metal can)</i></li> </ul> 
<ul style="list-style-type: none"> <li>• <i>All M600/605 230V Concentrators</i></li> <li>• <i>Enhanced M600/605 230V Concentrators</i></li> </ul>	1017607	<ul style="list-style-type: none"> <li>• <i>Capacitor 15 uf, 370 Volt (metal can)</i></li> <li>• <i>Foam</i></li> </ul> 


<b>CASTER KITS</b>		
<b>Concentrator Model #</b>	<b>Kit #</b>	<b>Included in Kit</b>
<ul style="list-style-type: none"> <li>• <i>All Millennium Concentrators</i></li> </ul>	<i>H624</i>	<ul style="list-style-type: none"> <li>• <i>Caster (x4) push in stem</i></li> </ul>
<ul style="list-style-type: none"> <li>• <i>All Millennium Concentrators</i></li> </ul>	<i>1026632</i>	<ul style="list-style-type: none"> <li>• <i>Caster (x1) push in stem</i></li> </ul> <div style="text-align: center;">  </div>
<ul style="list-style-type: none"> <li>• <i>All Millennium Concentrators</i></li> </ul>	<i>H649</i>	<ul style="list-style-type: none"> <li>• <i>Caster w/Brake (x2) push in stem</i></li> </ul> <div style="text-align: center;">  </div>

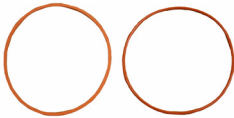
<b>COMPRESSOR KITS</b>		
<b>Concentrator Model #</b>	<b>Kit #</b>	<b>Included in Kit</b>
<ul style="list-style-type: none"> <li>• H600/H605 120V</li> <li>• M600/M605 120V</li> </ul>	<i>H611</i>	<ul style="list-style-type: none"> <li>• Compressor Assembly</li> <li>• One-eared Clamp</li> </ul> 
<ul style="list-style-type: none"> <li>• M10600/M10605</li> </ul>	<i>1017773</i>	
<ul style="list-style-type: none"> <li>• Enhanced M600/M605 120V</li> </ul>	<i>1023216</i>	
<ul style="list-style-type: none"> <li>• Enhanced M10600/M10605</li> </ul>	<i>1023219</i>	
<ul style="list-style-type: none"> <li>• M600/M605 230V (except M605-70)</li> </ul>	<i>1015613</i>	
<ul style="list-style-type: none"> <li>• M605-70</li> </ul>	<i>1015614</i>	
<ul style="list-style-type: none"> <li>• H600/H605 230V</li> </ul>	<i>H612</i>	
<ul style="list-style-type: none"> <li>• Enhanced M600-10</li> <li>• Enhanced M600-16</li> <li>• Enhanced M600-20</li> <li>• Enhanced M600-30</li> <li>• Enhanced M600-40</li> <li>• Enhanced M600-50</li> <li>• Enhanced M605-10</li> <li>• Enhanced M600-16</li> <li>• Enhanced M600-20</li> <li>• Enhanced M600-30</li> <li>• Enhanced M600-40</li> <li>• Enhanced M600-50</li> </ul>	<i>1023217</i>	
<ul style="list-style-type: none"> <li>• Enhanced M605-70</li> </ul>	<i>1023218</i>	

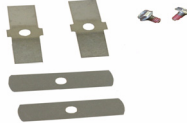

<b>SINGLE PORT TO FOUR PORT COMPRESSOR CONVERSION KIT</b>		
Concentrator Model #	Kit #	Included in Kit
<ul style="list-style-type: none"> <li>• <i>H600/H605 Only (Order Compressor Maintenance Kit RI p/n H610 to complete conversion)</i></li> </ul>	1007560	<ul style="list-style-type: none"> <li>• <i>Cylinder Sleeve (x1)</i></li> <li>• <i>Gasket-Valve Plate (x1)</i></li> <li>• <i>O Ring-Cylinder Sleeve (X1)</i></li> <li>• <i>Valve Plate Assembly (x1)</i></li> <li>• <i>Head/Pressure Relief Valve (x1)</i></li> <li>• <i>Cylinder Head (x1)</i></li> <li>• <i>Screw-Head (x4)</i></li> <li>• <i>Decal-Respironics Logo (x1)</i></li> <li>• <i>One-eared Clamp (x1)</i></li> </ul>

<b>COMPRESSOR INLET ADAPTOR KIT</b>		
Concentrator Model #	Kit #	Included in Kit
<ul style="list-style-type: none"> <li>• <i>M10600/M10605 Concentrators</i></li> <li>• <i>M600/M605 230V Concentrators</i></li> </ul>	1031501	<ul style="list-style-type: none"> <li>• <i>Pipe Nipple 1/4 x 1-1/2"</i></li> <li>• <i>Compressor Inlet Adapter</i></li> </ul> <div style="text-align: center;">  </div>

<b>COMPRESSOR ELBOW FITTING KIT</b>		
Concentrator Model #	Kit #	Included in Kit
<ul style="list-style-type: none"> <li>• <i>M10600/M10605 Concentrators</i></li> <li>• <i>M600/M605 230V Concentrators</i></li> </ul>	1030865	<ul style="list-style-type: none"> <li>• <i>Elbow Fitting 3/8" ID Hose</i></li> </ul> <div style="text-align: center;">  </div>


<b>SPARE PISTON CUP SEAL KIT</b>		
<b>Concentrator Model #</b>	<b>Kit #</b>	<b>Included in Kit</b>
<ul style="list-style-type: none"> <li>• <i>H600/H605 Concentrators</i></li> <li>• <i>M600/M605 Concentrators</i></li> <li>• <i>Enhanced M600/M605 Concentrators</i></li> </ul>	1027184	<ul style="list-style-type: none"> <li>• <i>Cup Seal</i></li> <li>• <i>Phillips Head Screws (x4)</i></li> </ul> <div style="text-align: center; margin-top: 10px;">  </div>

<b>SPARE GASKET &amp; SEAL KIT</b>		
<b>Concentrator Model #</b>	<b>Kit #</b>	<b>Included in Kit</b>
<ul style="list-style-type: none"> <li>• <i>H600/H605 Concentrators</i></li> <li>• <i>M600/M605 Concentrators</i></li> <li>• <i>Enhanced M600/M605 Concentrators</i></li> </ul>	1034057	<ul style="list-style-type: none"> <li>• <i>O-Ring</i></li> <li>• <i>Square Cut Gasket</i></li> </ul> <div style="text-align: center; margin-top: 10px;">  </div>

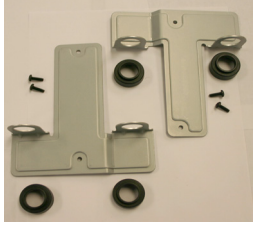
<b>SPARE PLATE, VALVE, FLAPPER KIT</b>		
<b>Concentrator Model #</b>	<b>Kit #</b>	<b>Included in Kit</b>
<ul style="list-style-type: none"> <li>• <i>H600/H605 Concentrators</i></li> <li>• <i>M600/M605 Concentrators</i></li> <li>• <i>Enhanced M600/M605 Concentrators</i></li> </ul>	1027185	<ul style="list-style-type: none"> <li>• <i>Retainer Screws (x2)</i></li> <li>• <i>Keepers (x2)</i></li> <li>• <i>Flapper valves (x2)</i></li> </ul> <div style="text-align: center; margin-top: 10px;">  </div>
<ul style="list-style-type: none"> <li>• <i>H600/H605 Concentrators</i></li> <li>• <i>M600/605 Concentrators</i></li> <li>• <i>Enhanced M600/M605 Concentrators</i></li> </ul>	1027187	<ul style="list-style-type: none"> <li>• <i>Retainer Screw (x1)</i></li> <li>• <i>Keeper (x1)</i></li> <li>• <i>Valve Flapper (x1)</i></li> </ul> <div style="text-align: center; margin-top: 10px;">  </div>

<b>COMPRESSOR MAINTENANCE KITS</b>		
<b>Concentrator Model #</b>	<b>Kit #</b>	<b>Included in Kit</b>
<ul style="list-style-type: none"> <li>• <i>H600/H605 Concentrators</i></li> <li>• <i>M600/M605 Concentrators</i></li> <li>• <i>Enhanced M600/M605 Concentrators</i></li> </ul>	H610	<ul style="list-style-type: none"> <li>• <i>Piston Cup</i></li> <li>• <i>Piston Cup Retainer</i></li> <li>• <i>Valve Keeper (exhaust)</i></li> <li>• <i>Valve Keeper (intake)</i></li> <li>• <i>Valve Flapper (exhaust)</i></li> <li>• <i>valve Flapper (intake)</i></li> <li>• <i>Cylinder Sleeve</i></li> <li>• <i>O-ring (sleeve)</i></li> <li>• <i>O-ring (intake filter cover)</i></li> <li>• <i>Gasket (intake)</i></li> <li>• <i>Felt Filter</i></li> <li>• <i>Screw, #6-32 x 3/16 (valve)</i></li> <li>• <i>Screw #10-24 x .625 (retainer)</i></li> <li>• <i>In-line Muffler (molded fittings)</i></li> <li>• <i>Clamp, One-eared Clamp</i></li> <li>• <i>Hose 3/8" ID Braided x 1 3/4"</i></li> </ul>
<ul style="list-style-type: none"> <li>• <i>All 230V Millennium Concentrators</i></li> </ul>	1015569	<ul style="list-style-type: none"> <li>• <i>Piston Cup (x2)</i></li> <li>• <i>Cup Retainer Screw (x2)</i></li> <li>• <i>Valve Keeper (x4)</i></li> <li>• <i>Head Screws (x8)</i></li> <li>• <i>Head Gasket (x2)</i></li> <li>• <i>Valve Restraint (x2)</i></li> <li>• <i>Valve (x4)</i></li> <li>• <i>Valve Screw (x4)</i></li> <li>• <i>Instruction Sheet</i></li> <li>• <i>Cylinder O-ring (x2)</i></li> <li>• <i>Cylinder O-ring (x2)</i></li> <li>• <i>Dynamic Backer (x2)</i></li> </ul>


<b>COMPRESSOR MAINTENANCE KITS</b>		
<ul style="list-style-type: none"> <li>• <i>M10600/M10605 Concentrators</i></li> <li>• <i>Enhanced M10600/M10605 Concentrators</i></li> </ul>	<p>1018249</p>	<ul style="list-style-type: none"> <li>• <i>Piston Cup (x2)</i></li> <li>• <i>Head screws (x8)</i></li> <li>• <i>Head Gasket (x2)</i></li> <li>• <i>Cup Retainer Screw (x2)</i></li> <li>• <i>Valve Restraint (x2)</i></li> <li>• <i>Cylinder Sleeve (x2)</i></li> <li>• <i>O-ring Sleeve (x2)</i></li> <li>• <i>Valve Keeper (x4)</i></li> <li>• <i>Valve (x4)</i></li> <li>• <i>Valve Screw (x4)</i></li> <li>• <i>Instruction Sheet</i></li> <li>• <i>Dynamic Backer (x4)</i></li> </ul>


<b>COMPRESSOR MOUNTING KITS</b>		
<b>Concentrator Model #</b>	<b>Kit #</b>	<b>Included in Kit</b>
<ul style="list-style-type: none"> <li>• <i>H600/H605 120V Concentrators</i></li> <li>• <i>M10600/M10605 Concentrators</i></li> </ul>	<p>H616</p>	<ul style="list-style-type: none"> <li>• <i>Spring, helical (x4)</i></li> <li>• <i>Compressor Bumper (x4)</i></li> <li>• <i>10-24 x 1.00" hex solder screw (x4)</i></li> </ul> <div style="text-align: center;">  </div>


<b>COMPRESSOR MOUNTING KITS</b>		
<ul style="list-style-type: none"> <li>• <i>H600/H605 230V Concentrators</i></li> </ul>	<p>1006095</p>	<ul style="list-style-type: none"> <li>• <i>Rubber Bumper (x4)</i></li> <li>• <i>Screw, #10-24 SOC HD x 1" Shoulder (x4)</i></li> <li>• <i>Bumper, 3/8" OD Black Tubing x 11/16" LG (x4)</i></li> <li>• <i>Spring, Gold Helical Compression (x2)</i></li> <li>• <i>Spring, Black Helical Compression (x2)</i></li> <li>• <i>Washer, #8 SAE Type A Plain (x4)</i></li> <li>• <i>Instruction Sheet</i></li> </ul>


<b>COMPRESSOR BRACKET KIT</b>		
Concentrator Model #	Kit #	Included in Kit
<ul style="list-style-type: none"> <li>• <i>M10600/M10605</i></li> <li>• <i>Enhanced M10600/M10605 Concentrators</i></li> <li>• <i>M600/M605 230V Concentrators</i></li> </ul>	<p>1018492</p>	<ul style="list-style-type: none"> <li>• <i>Mounting Brackets (x2)</i></li> <li>• <i>#8 x 1/2, Taptite, T-20 Torx Pan Head screws (x4)</i></li> <li>• <i>Compressor Spring Retainer (x4)</i></li> </ul> <div style="text-align: center; margin-top: 10px;">  </div>




<b>COMPRESSOR SPRING KIT</b>		
<b>Concentrator Model #</b>	<b>Kit #</b>	<b>Included in Kit</b>
<ul style="list-style-type: none"> <li>• <i>M600/M605 Concentrators</i></li> <li>• <i>Enhanced M600/M605 Concentrators</i></li> </ul>	1015582	<ul style="list-style-type: none"> <li>• <i>Spring, helical (x4)</i></li> </ul> <div style="text-align: center;">  </div>


<b>COMPRESSOR COVER/PERFORATED CANOPY KITS</b>		
<b>Concentrator Model #</b>	<b>Kit #</b>	<b>Included in Kit</b>
<ul style="list-style-type: none"> <li>• <i>H600/H605 Concentrators</i></li> <li>• <i>M600/M605 Concentrators</i></li> <li>• <i>M10600/M10605 Concentrators</i></li> </ul> <p style="margin-left: 20px;"><b><u>Serial Number Cutoff</u></b></p> <p style="margin-left: 20px;">M600: &lt; 600000023921</p> <p style="margin-left: 20px;">M605: &lt; 605000010395</p> <p style="margin-left: 20px;">M600-10: &lt; 600100001125</p> <p style="margin-left: 20px;">M600-16: &lt; 600160001002</p> <p style="margin-left: 20px;">M600-30: &lt; 600300001020</p> <p style="margin-left: 20px;">M600-40: &lt; 600400001201</p> <p style="margin-left: 20px;">M600-50: &lt; 600500001035</p> <p style="margin-left: 20px;">M605-10: &lt; 605100002563</p> <p style="margin-left: 20px;">M605-16: &lt; 605160001658</p> <p style="margin-left: 20px;">M605-20: &lt; 605200001384</p> <p style="margin-left: 20px;">M605-40: &lt; 605400001244</p> <p style="margin-left: 20px;">M605-50: &lt; 605500001949</p> <p style="margin-left: 20px;">M605-70: &lt; 605700001429</p> <p style="margin-left: 20px;">M10600: &lt; 106000001520</p> <p style="margin-left: 20px;">M10605: &lt; 106051001425</p>	H637	<ul style="list-style-type: none"> <li>• <i>Compressor Cover</i></li> <li>• <i>Compressor Foam</i></li> <li>• <i>Perforated Canopy</i></li> <li>• <i>Label (battery)</i></li> <li>• <i>Label (caution)</i></li> </ul> <div style="text-align: center;">  </div>

<b>COMPRESSOR COVER/PERFORATED CANOPY KITS</b>		
<ul style="list-style-type: none"> <li>• <i>M600/M605 Concentrators</i></li> <li>• <i>Enhanced M600/M605 Concentrators</i></li> <li>• <i>M10600/M10605 Concentrators</i></li> </ul> <p style="margin-left: 20px;"><b><u>Serial Number Cutoff</u></b></p> <p style="margin-left: 20px;">M600: &gt; 600000023921            M605: &gt; 605000010395            M600-10: &gt; 600100001125            M600-16: &gt; 600160001002            M600-20: Not in production as of Dec. 31, 2003            M600-30: &gt; 600300001020            M600-40: &gt; 600400001201            M600-50: &gt; 600500001035            M605-10: &gt; 605100002563            M605-16: &gt; 605160001658            M605-20: &gt; 605200001384            M605-30: &gt; Not in production as of Dec. 31, 2003            M605-40: &gt; 605400001244            M605-50: &gt; 605500001949            M605-70: &gt; 605700001429            M10600: &gt; 106000001520            M10605: &gt; 106051001425</p>	1018700	<ul style="list-style-type: none"> <li>• <i>Compressor Cover</i></li> <li>• <i>Compressor Foam</i></li> <li>• <i>Perforated Canopy</i></li> <li>• <i>Label (battery)</i></li> <li>• <i>Label (caution)</i></li> </ul> <div style="text-align: center; margin-top: 20px;">  </div>


<b>COOLING FAN KITS</b>		
<b>Concentrator Model #</b>	<b>Kit #</b>	<b>Included in Kit</b>
<ul style="list-style-type: none"> <li>• M10600/M10605 Concentrators</li> <li>• Enhanced M10600/M10605 Concentrators</li> </ul>	1014673	<ul style="list-style-type: none"> <li>• Cooling fan</li> </ul> 
<ul style="list-style-type: none"> <li>• H600/H605 Concentrators</li> <li>• M600/M605 Concentrators</li> <li>• Enhanced M600/M605 Concentrators</li> </ul>	360-9100-15	


<b>DISS OUTLET FITTING KIT</b>		
<b>Concentrator Model #</b>	<b>Kit #</b>	<b>Included in Kit</b>
<ul style="list-style-type: none"> <li>• All Millennium Concentrators</li> </ul>	H628	<ul style="list-style-type: none"> <li>• DISS outlet fitting</li> <li>• 1/2" lock washer</li> <li>• 1/2" - 13 jam nut (nylon)</li> </ul> 


<b>ELBOW/HOSE KIT</b>		
<b>Concentrator Model #</b>	<b>Kit #</b>	<b>Included in Kit</b>
<ul style="list-style-type: none"> <li>• All Millennium Concentrators</li> </ul>	1006510	<ul style="list-style-type: none"> <li>• Fitting, 3/8" hose barb, elbow, nylon</li> <li>• Hose braided (1 ft.)</li> <li>• One eared clamp</li> </ul>


<b>LONG LIFE FILTER KITS</b>		
<b>Concentrator Model #</b>	<b>Kit #</b>	<b>Included in Kit</b>
<ul style="list-style-type: none"> <li>• All M10 Concentrators</li> </ul>	1040395	<ul style="list-style-type: none"> <li>• Long Life Filter</li> </ul> 
<ul style="list-style-type: none"> <li>• Enhanced M600/M605 230V Concentrators</li> </ul>	1038485	

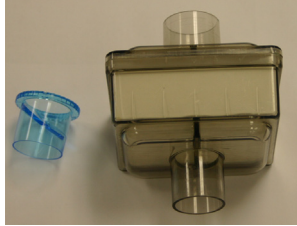
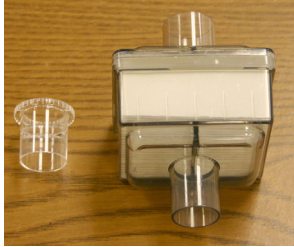
<b>LONG LIFE FILTER RETROFIT KIT</b>		
<b>Concentrator Model #</b>	<b>Kit #</b>	<b>Included in Kit</b>
<ul style="list-style-type: none"> <li>• Enhanced M600/M605 230V Concentrators</li> </ul>	1038364	<ul style="list-style-type: none"> <li>• Long Life Filter</li> <li>• Compressor Cover Adapter</li> <li>• Filter Canopy</li> <li>• Enclosure Seal</li> <li>• Labels</li> <li>• Screws</li> </ul>


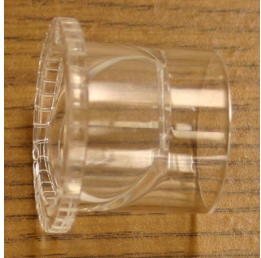
<b>AIR INLET FILTER KITS</b>		
<b>Concentrator Model #</b>	<b>Kit #</b>	<b>Included in Kit</b>
<ul style="list-style-type: none"> <li>• All Millennium Concentrators</li> </ul>	H619	<ul style="list-style-type: none"> <li>• Air Inlet Filter (x6)</li> </ul>
<ul style="list-style-type: none"> <li>• All Millennium Concentrators</li> </ul>	1022682	<ul style="list-style-type: none"> <li>• Air Inlet Filter (x1)</li> </ul> 


<b>WHISPER CAP KITS</b>		
<b>Concentrator Model #</b>	<b>Kit #</b>	<b>Included in Kit</b>
<ul style="list-style-type: none"> <li>• All M10600/M10605</li> <li>• M600/M605 230V Concentrators</li> </ul>	1017605	<ul style="list-style-type: none"> <li>• <i>Whisper Cap</i></li> </ul> <div style="text-align: center; margin-top: 10px;">  </div>
<ul style="list-style-type: none"> <li>• H600/H605 230V Concentrators</li> </ul>	1006511	

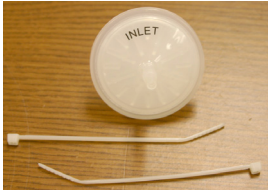
<b>INLET FILTER KITS</b>		
<b>Concentrator Model #</b>	<b>Kit #</b>	<b>Included in Kit</b>
<ul style="list-style-type: none"> <li>• All Millennium Concentrators</li> </ul>	H620	<ul style="list-style-type: none"> <li>• <i>Inlet Filter (x6)</i></li> </ul>
<ul style="list-style-type: none"> <li>• All Millennium Concentrators</li> </ul>	1022683	<ul style="list-style-type: none"> <li>• <i>Inlet Filter (x1)</i></li> </ul> <div style="text-align: center; margin-top: 10px;">  </div>


<b>SILICONE GROMMET KIT</b>		
<b>Concentrator Model #</b>	<b>Kit #</b>	<b>Included in Kit</b>
<ul style="list-style-type: none"> <li>• All Millennium Concentrators</li> </ul>	1015581	<ul style="list-style-type: none"> <li>• <i>Silicone Grommet (x10)</i></li> </ul> <div style="text-align: center; margin-top: 10px;">  </div>

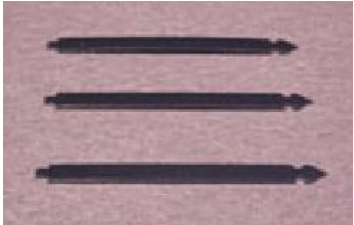
<b>INLET FILTER W/SILENCER KITS</b>		
<b>Concentrator Model #</b>	<b>Kit #</b>	<b>Included in Kit</b>
<ul style="list-style-type: none"> <li>• <i>M10600/M10605 Concentrators</i></li> <li>• <i>Enhanced M10600/M10605 Concentrators</i></li> </ul>	1017796	<ul style="list-style-type: none"> <li>• <i>Inlet Filter w/(blue) silencer (x6)</i></li> </ul> <div style="text-align: center;">  </div>
<ul style="list-style-type: none"> <li>• <i>All 230V Concentrators</i></li> </ul>	1015557	<ul style="list-style-type: none"> <li>• <i>Inlet Filter w/(clear) silencer (x6)</i></li> </ul> <div style="text-align: center;">  </div>


<b>SILENCER KITS</b>		
<b>Concentrator Model #</b>	<b>Kit #</b>	<b>Included in Kit</b>
<ul style="list-style-type: none"> <li>• <i>M10600/M10605 Concentrators</i></li> <li>• <i>Enhanced M10600/M10605 Concentrators</i></li> </ul>	1014672	<ul style="list-style-type: none"> <li>• <i>Silencer, M10 (blue)</i></li> </ul> <div style="text-align: center;">  </div>
<ul style="list-style-type: none"> <li>• <i>All 230V Concentrators</i></li> </ul>	1018485	<ul style="list-style-type: none"> <li>• <i>Silencer, M10 (clear) (x12)</i></li> </ul> <div style="text-align: center;">  </div>


<b>PRE-INLET FILTER KITS</b>		
<b>Concentrator Model #</b>	<b>Kit #</b>	<b>Included in Kit</b>
• <i>All Millennium Concentrators</i>	<i>H618</i>	• <i>Pre-inlet Filter (x6)</i>
• <i>All Millennium Concentrators</i>	1022681	• <i>Pre-inlet Filter (x1)</i>  <div style="text-align: center;">  </div>

<b>MICRO-DISK FILTER KIT</b>		
<b>Concentrator Model #</b>	<b>Kit #</b>	<b>Included in Kit</b>
• <i>All Millennium Concentrators</i>	<i>H621</i>	• <i>Micro-disk Filter (x6)</i>  <div style="text-align: center;">  </div>


<b>RETAINER INLET FILTER KITS</b>		
<b>Concentrator Model #</b>	<b>Kit #</b>	<b>Included in Kit</b>
• <i>H600/H605 Concentrators</i>	<i>1007561</i>	• <i>Retainer Inlet Filter (x10)</i>  <div style="text-align: center;">  </div>
• <i>H600/H605 Concentrators</i>	1006691	• <i>Retainer Inlet Filter (x1)</i>


<b>RETAINER AIR INTAKE KIT</b>		
<b>Concentrator Model #</b>	<b>Kit #</b>	<b>Included in Kit</b>
<ul style="list-style-type: none"> <li>• <i>H600/H605 Concentrators</i></li> </ul>	<p style="text-align: center;"><i>H654</i></p>	<ul style="list-style-type: none"> <li>• <i>Retainer Intake Filter (x10)</i></li> </ul> <div style="text-align: center; margin-top: 10px;">  </div>


<b>FILTER COVER KIT</b>		
<b>Concentrator Model #</b>	<b>Kit #</b>	<b>Included in Kit</b>
<ul style="list-style-type: none"> <li>• <i>H600/H605 Concentrators</i></li> <li>• <i>M600/M605 Concentrators</i></li> <li>• <i>Enhanced M600/605 Concentrators</i></li> </ul>	<p style="text-align: center;"><i>H652</i></p>	<ul style="list-style-type: none"> <li>• <i>Filter Cover</i></li> </ul> <div style="text-align: center; margin-top: 10px;">  </div>

<b>FELT FILTER KIT</b>		
<b>Concentrator Model #</b>	<b>Kit #</b>	<b>Included in Kit</b>
<ul style="list-style-type: none"> <li>• <i>H600/H605 Concentrators</i></li> <li>• <i>M600/M605 Concentrators</i></li> <li>• <i>Enhanced M600/M605 Concentrators</i></li> </ul>	<p style="text-align: center;"><i>H653</i></p>	<ul style="list-style-type: none"> <li>• <i>Felt Filter (x6)</i></li> </ul> <div style="text-align: center; margin-top: 10px;">  </div>




<b>FLOW METER KITS</b>		
<b>Concentrator Model #</b>	<b>Kit #</b>	<b>Included in Kit</b>
<ul style="list-style-type: none"> <li>• <i>H600/H605 Concentrators</i></li> <li>• <i>M600/M605 Concentrators</i></li> <li>• <i>Enhanced M600/M605 Concentrators</i></li> </ul>	<i>H627</i>	<ul style="list-style-type: none"> <li>• <i>Flow Meter (5 lpm)</i></li> <li>• <i>Speed Nuts (x2)</i></li> <li>• <i>Cable tie (x2)</i></li> </ul> 
<ul style="list-style-type: none"> <li>• <i>M10600/M10605 Concentrators</i></li> <li>• <i>Enhanced M10600/M10605 Concentrators</i></li> </ul>	<i>1017847</i>	<ul style="list-style-type: none"> <li>• <i>Flow Meter (10 lpm)</i></li> <li>• <i>Speed Nuts (x2)</i></li> <li>• <i>Cable tie (x2)</i></li> </ul>
<ul style="list-style-type: none"> <li>• <i>H600/H605 Concentrators</i></li> <li>• <i>M600/M605 Concentrators</i></li> <li>• <i>Enhanced M600/M605 Concentrators</i></li> </ul>	<i>H644</i>	<ul style="list-style-type: none"> <li>• <i>Pediatric Flow Meter (1 lpm)</i></li> <li>• <i>Speed Nuts (x2)</i></li> <li>• <i>Cable tie (x2)</i></li> </ul>
<ul style="list-style-type: none"> <li>• <i>H600/H605 Concentrators</i></li> <li>• <i>M600/M605 Concentrators</i></li> <li>• <i>Enhanced M600/M605 Concentrators</i></li> </ul>	<i>528</i>	<ul style="list-style-type: none"> <li>• <i>Locking Flow Meter</i></li> <li>• <i>Speed Nuts (x2)</i></li> <li>• <i>Allen Wrench</i></li> <li>• <i>Instruction Sheet</i></li> </ul>


<b>FLOW METER KNOB KIT</b>		
<b>Concentrator Model #</b>	<b>Kit #</b>	<b>Included in Kit</b>
<ul style="list-style-type: none"> <li>• <i>All Millennium Concentrators</i></li> </ul>	<p>1029720</p>	<ul style="list-style-type: none"> <li>• <i>Flowmeter Knob</i></li> </ul> <div style="text-align: center; margin-top: 10px;">  </div>



<b>STAND ALONE PEDIATRIC FLOW METER KIT</b>		
<b>Concentrator Model #</b>	<b>Kit #</b>	<b>Included in Kit</b>
<ul style="list-style-type: none"> <li>• <i>H600/H605 Concentrators</i></li> <li>• <i>M600/M605 Concentrators</i></li> <li>• <i>Enhanced M600/M605 Concentrators</i></li> </ul>	<p>H537-1</p>	<ul style="list-style-type: none"> <li>• <i>Stand alone Pediatric Flow Meter (1 lpm)</i></li> <li>• <i>Instruction Sheet</i></li> </ul> <div style="text-align: center; margin-top: 10px;">  </div>



<b>FOAM KIT</b>		
<b>Concentrator Model #</b>	<b>Kit #</b>	<b>Included in Kit</b>
<ul style="list-style-type: none"><li>• <i>All Millennium Concentrators</i></li></ul>	<i>H623</i>	<ul style="list-style-type: none"><li>• <i>Front Cabinet foam</i></li><li>• <i>Rear Cabinet foam</i></li><li>• <i>Compressor housing foam</i></li><li>• <i>Base foam assembly</i></li><li>• <i>Base foam, Compressor</i></li><li>• <i>Base foam, hose port</i></li><li>• <i>Base bottom pan foam</i></li></ul>

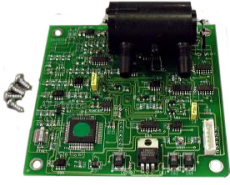
<b>FRONT CABINET KITS</b>		
<b>Concentrator Model #</b>	<b>Kit #</b>	<b>Included in Kit</b>
• H600/H605 120V	1008689	<ul style="list-style-type: none"> <li>• Front Cabinet</li> <li>• Control Overlay</li> <li>• Front Cabinet Foam</li> <li>• Screws</li> <li>• Cable ties</li> <li>• Power Switch Bezel</li> </ul>
• M600 120V	1015606	
• M605 120V	1015607	
• Enhanced M600	1023212	
• Enhanced M605	1023213	
• M10600/M10605	1018248	
• Enhanced M600-10	1023214	
• Enhanced M600-16		
• Enhanced M600-20		
• Enhanced M600-30		
• Enhanced M600-40		
• Enhanced M600-50		
• Enhanced M605-10		
• Enhanced M605-16		
• Enhanced M605-20		
• Enhanced M605-30		
• Enhanced M605-40		
• Enhanced M605-50		
• Enhanced M10600/M10605	1023236	
• M605-70	1017598	
• Enhanced M605-70	1023235	
• H600/H605 230V	1008732	
• M600/M605 230V (except M605-70)	1015618	

<b>MAIN PCA FUSE KITS</b>		
<b>Concentrator Model #</b>	<b>Kit #</b>	<b>Included in Kit</b>
<ul style="list-style-type: none"> <li>• All 120V Millennium Concentrators</li> </ul>	H638	<ul style="list-style-type: none"> <li>• 125mA @ 250 V, 5mm x 20mm (2 pack)</li> </ul>
<ul style="list-style-type: none"> <li>• All 230V Millennium Concentrators</li> </ul>	H639	<ul style="list-style-type: none"> <li>• .063 A @ 250 V, SLO-BLO 5mm x 20mm (2 pack)</li> </ul> <div style="text-align: center; margin-top: 10px;">  </div>

<b>GASKET KITS</b>		
<b>Concentrator Model #</b>	<b>Kit #</b>	<b>Included in Kit</b>
<ul style="list-style-type: none"> <li>• H600/H605 Concentrators</li> <li>• M600/M605 Concentrators</li> <li>• Enhanced M600/M605 Concentrators</li> </ul>	1007715	<ul style="list-style-type: none"> <li>• Bottom Gasket (x2)</li> <li>• Foam Pad</li> <li>• Instructions</li> <li>• One-eared clamp</li> </ul> <div style="text-align: center; margin-top: 10px;">  </div>
<ul style="list-style-type: none"> <li>• H600/H605 Concentrators</li> <li>• M600/M605 Concentrators</li> <li>• Enhanced M600/M605 Concentrators</li> </ul>	1009057	<ul style="list-style-type: none"> <li>• Bottom Gasket (x10)</li> <li>• Foam Pad (X5)</li> <li>• Instructions</li> <li>• One-eared clamp (x5)</li> </ul>

<b>HOURLY METER KITS</b>		
<b>Concentrator Model #</b>	<b>Kit #</b>	<b>Included in Kit</b>
<ul style="list-style-type: none"> <li>• <i>H600/H605 Concentrators</i></li> <li>• <i>M600/M605 Concentrators</i></li> <li>• <i>M10600/M10605 Concentrators</i></li> </ul>	199-0600-60	<ul style="list-style-type: none"> <li>• <i>Hour Meter</i></li> <li>• <i>Locking frame</i></li> </ul> 
<ul style="list-style-type: none"> <li>• <i>Enhanced M600/M605 Concentrators</i></li> <li>• <i>Enhanced M10600/M10605</i></li> </ul>	1017578	<ul style="list-style-type: none"> <li>• <i>Hour Meter</i></li> </ul> 

<b>IN-LINE MUFFLER KITS</b>		
<b>Concentrator Model #</b>	<b>Kit #</b>	<b>Included in Kit</b>
<ul style="list-style-type: none"> <li>• All 120V Millennium Concentrators</li> </ul>	<p>H622</p>	<ul style="list-style-type: none"> <li>• In-line Muffler (molded fittings)</li> <li>• One-eared clamp</li> <li>• Hose, 3/8" ID braided 1 3/4"</li> </ul> <div style="text-align: center;">  </div>
<ul style="list-style-type: none"> <li>• All 230V Millennium Concentrators</li> </ul>	<p>1018460</p>	<ul style="list-style-type: none"> <li>• In-line Muffler (molded fittings)</li> <li>• One-eared clamp</li> <li>• Hose, 3/8" ID braided 1-3/4" lg</li> <li>• Hose, 3/8" ID braided 10-1/4" lg</li> <li>• Foam</li> </ul> <div style="text-align: center;">  </div>


<b>OPI PCB KIT</b>		
<b>Concentrator Model #</b>	<b>Kit #</b>	<b>Included in Kit</b>
<ul style="list-style-type: none"> <li>• <i>H605 Concentrators</i></li> <li>• <i>M605 Concentrators</i></li> <li>• <i>Enhanced M605 Concentrators</i></li> <li>• <i>M10605 Concentrators</i></li> <li>• <i>Enhanced M10605 Concentrators</i></li> </ul>	<i>H633</i>	<ul style="list-style-type: none"> <li>• <i>OPI PCB</i></li> <li>• <i>Screw, 6-19 x.31 pan head low torque (x4)</i></li> </ul> <div style="text-align: center;">  </div>





<b>OVERLY KITS</b>		
<b>Concentrator Model #</b>	<b>Kit #</b>	<b>Included in Kit</b>
• <i>H600 Concentrators</i>	<i>1008342</i>	• <i>H600 Control Overlay</i>
• <i>H605 Concentrators</i>	<i>1008344</i>	• <i>H605 Control Overlay</i>
• <i>M10600 Concentrators</i>	<i>1015870</i>	• <i>M10600 Control Overlay</i>
• <i>M10605 Concentrators</i>	<i>1015871</i>	• <i>M10605 Control Overlay</i>
• <i>Enhanced M600 Concentrators</i>	<i>1020645</i>	• <i>Enhanced M600 Control Overlay</i>
• <i>Enhanced M605 Concentrators</i>	<i>1020646</i>	• <i>Enhanced M605 Control Overlay</i>
• <i>Enhanced M10600 Concentrators</i>	<i>1020650</i>	• <i>Enhanced M10600 Control Overlay</i>
• <i>Enhanced M10605 Concentrators</i>	<i>1020651</i>	• <i>Enhanced M10605 Control Overlay</i>
• <i>H600 230V Concentrator</i> • <i>M600 230V Concentrator</i>	<i>H340-0600-10</i>	• <i>Model 600 230V Control Overlay</i>
• <i>H605 230V Concentrator</i> • <i>M605 230V Concentrator</i>	<i>H340-0605-10</i>	• <i>Model 605 230V Control Overlay</i>
• <i>Enhanced M600-10 Concentrator</i> • <i>Enhanced M600-6 Concentrator</i> • <i>Enhanced M600-20 Concentrator</i> • <i>Enhanced M600-30 Concentrator</i> • <i>Enhanced M600-40 Concentrator</i> • <i>Enhanced M600-50 Concentrator</i>	<i>1020647</i>	• <i>M600 Control Overlay</i>


OVERLY KITS		
<ul style="list-style-type: none"> <li>• <i>Enhanced M605-10 Concentrator</i></li> <li>• <i>Enhanced M605-16 Concentrator</i></li> <li>• <i>Enhanced M605-20 Concentrator</i></li> <li>• <i>Enhanced M605-30 Concentrator</i></li> <li>• <i>Enhanced M605-40 Concentrator</i></li> <li>• <i>Enhanced M605-50 Concentrator</i></li> <li>• <i>Enhanced M605-70 Concentrator</i></li> </ul>	<p>1020649</p>	<ul style="list-style-type: none"> <li>• <i>M605 Control Overlay</i></li> </ul>


<b>WARNING/INSTRUCTION LABEL KITS</b>		
<b>Concentrator Model #</b>	<b>Kit #</b>	<b>Included in Kit</b>
<ul style="list-style-type: none"> <li>• <i>H600/H605 Concentrators</i></li> <li>• <i>M600/M605 Concentrators</i></li> <li>• <i>Enhanced M600/M605 Concentrators</i></li> <li>• <i>M10600/M10605 Concentrators</i></li> <li>• <i>Enhanced M10600/M10605 Concentrators</i></li> </ul>	<i>320-0650-00</i>	<ul style="list-style-type: none"> <li>• <i>Warning Label</i></li> </ul>
<ul style="list-style-type: none"> <li>• <i>M600-10 Concentrators</i></li> <li>• <i>M600-16 Concentrators</i></li> <li>• <i>M600-50 Concentrators</i></li> <li>• <i>M605-10 Concentrators</i></li> <li>• <i>M605-11 Concentrators</i></li> <li>• <i>M605-15 Concentrators</i></li> <li>• <i>M605-50 Concentrators</i></li> <li>• <i>M605-70 Concentrators</i></li> <li>• <i>M605-90 Concentrators</i></li> </ul>	<i>H320-0650-10</i>	<ul style="list-style-type: none"> <li>• <i>Warning/Instruction Label (English, French, German, Spanish, Italian)</i></li> </ul>
<ul style="list-style-type: none"> <li>• <i>H600-20 Concentrators</i></li> <li>• <i>H605-20 Concentrators</i></li> <li>• <i>M600-20 Concentrators</i></li> <li>• <i>M605-20 Concentrators</i></li> </ul>	<i>H320-0650-20</i>	<ul style="list-style-type: none"> <li>• <i>Warning/Instruction Label (English, Greek, Swedish, Danish, Dutch, Finnish)</i></li> </ul>
<ul style="list-style-type: none"> <li>• <i>H600-30 Concentrators</i></li> <li>• <i>H605-30 Concentrators</i></li> <li>• <i>M600-30 Concentrators</i></li> <li>• <i>M605-30 Concentrators</i></li> </ul>	<i>H320-0650-30</i>	<ul style="list-style-type: none"> <li>• <i>Warning/Instruction Label (English, Hebrew, Slovene, Turkish, Polish)</i></li> </ul>
<ul style="list-style-type: none"> <li>• <i>H600-40 Concentrators</i></li> <li>• <i>H605-40 Concentrators</i></li> <li>• <i>M600-40 Concentrators</i></li> <li>• <i>M605-40 Concentrators</i></li> </ul>	<i>H320-0650-40</i>	<ul style="list-style-type: none"> <li>• <i>Warning/Instruction Label (English, Portuguese, Norwegian, Hungarian, Czechoslovakia)</i></li> </ul>

<b>PERFORATED CANOPY KIT</b>		
<b>Concentrator Model #</b>	<b>Kit #</b>	<b>Included in Kit</b>
<ul style="list-style-type: none"> <li>• <i>All Millennium Concentrators</i></li> </ul>	260-0671-00	<ul style="list-style-type: none"> <li>• <i>Perforated Canopy</i></li> </ul> <div style="text-align: center;">  </div>

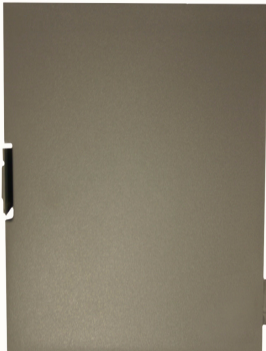
<b>POWER SWITCH KITS</b>		
<b>Concentrator Model #</b>	<b>Kit #</b>	<b>Included in Kit</b>
<ul style="list-style-type: none"> <li>• <i>H600/H605 Concentrators</i></li> <li>• <i>M600/M605 Concentrators</i></li> <li>• <i>M10600/M10605 Concentrators</i></li> </ul>	441-0600-00	<ul style="list-style-type: none"> <li>• <i>Power Switch</i></li> </ul> <div style="text-align: center;">  </div>
<ul style="list-style-type: none"> <li>• <i>Enhanced M600/M605 Concentrators</i></li> <li>• <i>Enhanced M10600/M10605 Concentrators</i></li> </ul>	1017563	<ul style="list-style-type: none"> <li>• <i>Power Switch</i></li> </ul>

<b>PRESSURE REGULATOR KIT</b>		
<b>Concentrator Model #</b>	<b>Kit #</b>	<b>Included in Kit</b>
<ul style="list-style-type: none"> <li>• <i>All Millennium Concentrators</i></li> </ul>	<p style="text-align: center;">365-0001-00</p>	<ul style="list-style-type: none"> <li>• <i>Pressure Regulator</i></li> </ul> <div style="text-align: center;">  </div>

<b>PRESSURE RELIEF VALVE KIT</b>		
<b>Concentrator Model #</b>	<b>Kit #</b>	<b>Included in Kit</b>
<ul style="list-style-type: none"> <li>• <i>H600/H605 Concentrators</i></li> </ul>	<p style="text-align: center;">365-0600-10</p>	<ul style="list-style-type: none"> <li>• <i>Pressure Relief Valve</i></li> </ul> <div style="text-align: center;">  </div>

<b>MAIN PCA KITS</b>		
<b>Concentrator Model #</b>	<b>Kit #</b>	<b>Included in Kit</b>
<ul style="list-style-type: none"> <li>• <i>H600 120V Concentrators</i></li> <li>• <i>M600 120V Concentrators</i></li> </ul>	<i>H629</i>	<ul style="list-style-type: none"> <li>• <i>Main PCA</i></li> <li>• <i>6-19 x.31 pan head low torque screw (x4)</i></li> </ul> 
<ul style="list-style-type: none"> <li>• <i>H605 120V Concentrators</i></li> <li>• <i>M605 120V Concentrators</i></li> </ul>	<i>H630</i>	
<ul style="list-style-type: none"> <li>• <i>M10600 Concentrators</i></li> </ul>	<i>1017797</i>	
<ul style="list-style-type: none"> <li>• <i>M10605 Concentrators</i></li> </ul>	<i>1017798</i>	
<ul style="list-style-type: none"> <li>• <i>H600 230V Concentrators</i></li> <li>• <i>M600 230V Concentrators</i></li> </ul>	<i>H631</i>	
<ul style="list-style-type: none"> <li>• <i>H605 230V Concentrators</i></li> <li>• <i>M605 230V Concentrators (except M605-70)</i></li> </ul>	<i>H632</i>	
<ul style="list-style-type: none"> <li>• <i>Enhanced M600 120V Concentrators</i></li> </ul>	<i>1023199</i>	
<ul style="list-style-type: none"> <li>• <i>Enhanced M605 120V Concentrators</i></li> </ul>	<i>1023200</i>	
<ul style="list-style-type: none"> <li>• <i>Enhanced M10600 Concentrators</i></li> </ul>	<i>1023201</i>	
<ul style="list-style-type: none"> <li>• <i>Enhanced M10605 Concentrators</i></li> </ul>	<i>1023202</i>	
<ul style="list-style-type: none"> <li>• <i>M605-70 Concentrators</i></li> </ul>	<i>1018463</i>	
<ul style="list-style-type: none"> <li>• <i>Enhanced M600-10 Concentrators</i></li> <li>• <i>Enhanced M600-16 Concentrators</i></li> <li>• <i>Enhanced M600-20 Concentrators</i></li> <li>• <i>Enhanced M600-30 Concentrators</i></li> <li>• <i>Enhanced M600-40 Concentrators</i></li> <li>• <i>Enhanced M600-50 Concentrators</i></li> </ul>	<i>1023203</i>	
<ul style="list-style-type: none"> <li>• <i>Enhanced M605-10 Concentrators</i></li> <li>• <i>Enhanced M605-16 Concentrators</i></li> <li>• <i>Enhanced M605-20 Concentrators</i></li> <li>• <i>Enhanced M605-30 Concentrators</i></li> <li>• <i>Enhanced M605-40 Concentrators</i></li> <li>• <i>Enhanced M605-50 Concentrators</i></li> </ul>	<i>1023204</i>	
<ul style="list-style-type: none"> <li>• <i>Enhanced M605-70 Concentrators</i></li> </ul>	<i>1023215</i>	


<b>POWER CORD KIT</b>		
<b>Concentrator Model #</b>	<b>Kit #</b>	<b>Included in Kit</b>
<ul style="list-style-type: none"> <li>• <i>H600/H605 120V Concentrators</i></li> <li>• <i>M600/M605 120V Concentrators</i></li> <li>• <i>M10600/M10605 Concentrators</i></li> </ul>	<i>H617</i>	<ul style="list-style-type: none"> <li>• <i>Power Cord</i></li> <li>• <i>Strain Relief</i></li> </ul>


<b>REAR ACCESS DOOR KITS</b>		
<b>Concentrator Model #</b>	<b>Kit #</b>	<b>Included in Kit</b>
<ul style="list-style-type: none"> <li>• <i>H600/H605 Concentrators</i></li> </ul>	<i>1008750</i>	<ul style="list-style-type: none"> <li>• <i>Rear Access Door w/foam</i></li> </ul>
<ul style="list-style-type: none"> <li>• <i>M600/M605 Concentrators</i></li> <li>• <i>Enhanced M600/M605 Concentrators</i></li> <li>• <i>M10600/M10605 Concentrators</i></li> <li>• <i>Enhanced M10600/M10605 Concentrators</i></li> </ul>	<i>1015609</i>	<ul style="list-style-type: none"> <li>• <i>Rear Access Door w/foam</i></li> </ul> <div style="text-align: center;">  </div>

<b>REAR CABINET KITS</b>		
<b>Concentrator Model #</b>	<b>Kit #</b>	<b>Included in Kit</b>
<ul style="list-style-type: none"> <li>• <i>H600/H605 120V Concentrators</i></li> </ul>	<i>1008752</i>	<ul style="list-style-type: none"> <li>• <i>Rear Cabinet w/foam</i></li> <li>• <i>Access door w/foam</i></li> <li>• <i>Instruction label</i></li> <li>• <i>10-32 x 1/2" pan head phillips screw (x6)</i></li> <li>• <i>Cable tie</i></li> <li>• <i>Replacement Serial Number Plate</i></li> <li>• <i>Clear Overlay (x2)</i></li> <li>• <i>Instruction Sheet</i></li> </ul>
<ul style="list-style-type: none"> <li>• <i>M600/M605 120V Concentrators</i></li> <li>• <i>Enhanced M600/M605 Concentrators</i></li> </ul>	<i>1015608</i>	
<ul style="list-style-type: none"> <li>• <i>M600/M605 230V (except Model M605-70)</i></li> </ul>	<i>1017599</i>	
<ul style="list-style-type: none"> <li>• <i>M605-70 Concentrators</i></li> </ul>	<i>1017600</i>	
<ul style="list-style-type: none"> <li>• <i>H600/H605 230V Concentrators</i></li> </ul>	<i>1006498</i>	
<ul style="list-style-type: none"> <li>• <i>M10600/M10605 Concentrators</i></li> <li>• <i>Enhanced M10600/M10605 Concentrators</i></li> </ul>	<i>1043691</i>	

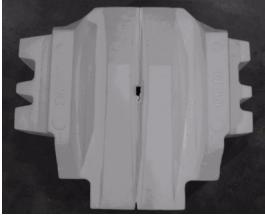
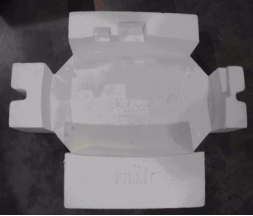


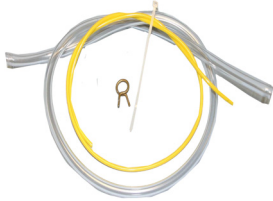
<b>SERIAL NUMBER PLATE KITS</b>		
<b>Concentrator Model #</b>	<b>Kit #</b>	<b>Included in Kit</b>
<ul style="list-style-type: none"> <li>• <i>M10600/ M10605 Concentrators</i></li> </ul>	<i>1039550</i>	<ul style="list-style-type: none"> <li>• <i>Replacement Serial Number Plate</i></li> <li>• <i>Clear Overlay (x2)</i></li> <li>• <i>Instruction Sheet</i></li> </ul>
<ul style="list-style-type: none"> <li>• <i>H600/H605 230V Concentrators</i></li> <li>• <i>M600/M605 230V Concentrators</i></li> </ul>	<i>1039551</i>	
<ul style="list-style-type: none"> <li>• <i>H605-70 Concentrators</i></li> <li>• <i>M605-70 Concentrators</i></li> </ul>	<i>1039552</i>	
<ul style="list-style-type: none"> <li>• <i>H600/H605 120V Concentrators</i></li> <li>• <i>M600/M605 120V Concentrators</i></li> </ul>	<i>1039553</i>	



<b>ONE-EARED CLAMP KIT</b>		
<b>Concentrator Model #</b>	<b>Kit #</b>	<b>Included in Kit</b>
<ul style="list-style-type: none"> <li>• <i>All Millennium Concentrators</i></li> </ul>	<i>H640</i>	<ul style="list-style-type: none"> <li>• <i>One-eared Clamp (10 pack)</i></li> </ul> <div style="text-align: center;">  </div>

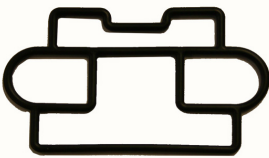
<b>SIEVE CANISTER KITS</b>		
<b>Concentrator Model #</b>	<b>Kit #</b>	<b>Included in Kit</b>
<ul style="list-style-type: none"> <li>• H600/H605 120V Concentrators</li> <li>• M600/605 Concentrators</li> <li>• Enhanced M600/M605 Concentrators</li> </ul>	H614	<ul style="list-style-type: none"> <li>• Sieve Canister Module Assembly</li> <li>• Foam (cabinet bottom)</li> <li>• One-eared clamp</li> </ul> 
<ul style="list-style-type: none"> <li>• M10600/M10605 Concentrators</li> <li>• Enhanced M10600/M10605 Concentrators</li> </ul>	1017774	
<ul style="list-style-type: none"> <li>• H600/H605 230V Concentrators</li> </ul>	H613	


<b>SHIPPING CARTON KITS</b>		
<b>Concentrator Model #</b>	<b>Kit #</b>	<b>Included in Kit</b>
<ul style="list-style-type: none"> <li>• M600/M605 Concentrators</li> <li>• Enhanced M600/M605 Concentrators</li> <li>• M10600/M10605 Concentrators</li> <li>• Enhanced M10600/M10605 Concentrators</li> </ul>	1019347	<ul style="list-style-type: none"> <li>• Shipping Carton</li> <li>• Bottom Insert</li> <li>• Top Insert</li> <li>• Poly bag</li> </ul>
<ul style="list-style-type: none"> <li>• H600/H605 Concentrators</li> </ul>	1019346	
<ul style="list-style-type: none"> <li>• All Millennium Concentrators</li> </ul>	1017903	<ul style="list-style-type: none"> <li>• Shipping Carton</li> </ul>

<b>SHIPPING CARTON INSERT KITS</b>		
<b>Concentrator Model #</b>	<b>Kit #</b>	<b>Included in Kit</b>
<ul style="list-style-type: none"> <li>• All Millennium Concentrators</li> </ul>	1018702	<ul style="list-style-type: none"> <li>• Top Insert</li> </ul> 
<ul style="list-style-type: none"> <li>• H600/H605 Concentrators</li> </ul>	1018699	<ul style="list-style-type: none"> <li>• Bottom Insert</li> </ul> 
<ul style="list-style-type: none"> <li>• M600/M605 Concentrators</li> <li>• Enhanced M600/M605 Concentrators</li> <li>• M10600/M10605 Concentrators</li> <li>• Enhanced M10600/M10605 Concentrators</li> </ul>	1018705	


<b>TUBING KIT</b>		
<b>Concentrator Model #</b>	<b>Kit #</b>	<b>Included in Kit</b>
<ul style="list-style-type: none"> <li>• All Millennium Concentrators</li> </ul>	1024105	<ul style="list-style-type: none"> <li>• Yellow Pressure Tubing</li> <li>• Cable Tie w/Screw Mount (x5)</li> <li>• Cable Tie (x2)</li> <li>• Hose Clamp, Self Tightening</li> <li>• Tubing, 3/16" ID x 5/16" OD Clear PVC</li> <li>• Tubing, 3/16" ID x 5/16" OD PVC Formed</li> <li>• Tubing, 1/4" ID x 3/8" OD PVC</li> </ul> 

<b>VALVE/SOLENOID KITS</b>		
<b>Concentrator Model #</b>	<b>Kit #</b>	<b>Included in Kit</b>
<ul style="list-style-type: none"> <li>• <i>H600/H605 Concentrators</i></li> <li>• <i>M600/M605 Concentrators</i></li> <li>• <i>M10600/M10605 Concentrators</i></li> </ul>	<i>H625</i>	<ul style="list-style-type: none"> <li>• <i>Valve/Solenoid Assembly</i></li> <li>• <i>6-32 x 1/2" screw nypatch (x5)</i></li> <li>• <i>#6 washer, flat (x5)</i></li> </ul> <div style="text-align: center;">  </div>
<ul style="list-style-type: none"> <li>• <i>Enhanced M600/M605 Concentrators</i></li> <li>• <i>Enhanced M10600/M10605 Concentrators</i></li> </ul>	<i>1023349</i>	<ul style="list-style-type: none"> <li>• <i>Valve/Solenoid Assembly</i></li> <li>• <i>6-32 x 1/2" screw nypatch (x5)</i></li> <li>• <i>#6 washer, flat (x5)</i></li> </ul> <div style="text-align: center;">  </div>


<b>SOLENOID GASKET KIT</b>		
<b>Concentrator Model #</b>	<b>Kit #</b>	<b>Included in Kit</b>
<ul style="list-style-type: none"> <li>• <i>All Millennium Concentrators</i></li> </ul>	1012724	<ul style="list-style-type: none"> <li>• <i>Valve/Solenoid Gasket (x20)</i></li> </ul> <div style="text-align: center;">  </div>


<b>MAIN POWER WIRING HARNESS KITS</b>		
<b>Concentrator Model #</b>	<b>Kit #</b>	<b>Included in Kit</b>
<ul style="list-style-type: none"> <li>• <i>H600/H605 120V Concentrators</i></li> <li>• <i>M600/M605 120V Concentrators</i></li> </ul>	610-00620-00	<ul style="list-style-type: none"> <li>• <i>Main Power Wiring Harness</i></li> </ul> <div style="text-align: center;">  </div>
<ul style="list-style-type: none"> <li>• <i>M10600/M10605 Concentrators</i></li> </ul>	1014669	<ul style="list-style-type: none"> <li>• <i>Main Power Wiring Harness</i></li> </ul>
<ul style="list-style-type: none"> <li>• <i>M600/M605 230V Concentrators</i></li> </ul>	1015562	<ul style="list-style-type: none"> <li>• <i>Main Power Wiring Harness</i></li> </ul>
<ul style="list-style-type: none"> <li>• <i>H600/H605 230V Concentrators</i></li> </ul>	610-00640-00	<ul style="list-style-type: none"> <li>• <i>Main Power Wiring Harness</i></li> </ul>


<b>O<sub>2</sub>/SOLENOID/BATTERY WIRING HARNESS KIT</b>		
Concentrator Model #	Kit #	Included in Kit
<ul style="list-style-type: none"> <li>• <i>H600/H605 Concentrators</i></li> <li>• <i>M600/M605 Concentrators</i></li> <li>• <i>M10600/M10605 Concentrators</i></li> </ul>	610-00600-00	<ul style="list-style-type: none"> <li>• <i>O<sub>2</sub>/Solenoid/Battery Wiring Harness</i></li> </ul>


<b>OPI/O<sub>2</sub>/SOLENOID/BATTERY WIRING HARNESS KIT</b>		
Concentrator Model #	Kit #	Included in Kit
<ul style="list-style-type: none"> <li>• <i>H600/H605 Concentrators</i></li> <li>• <i>M600/M605 Concentrators</i></li> <li>• <i>M10600/M10605 Concentrators</i></li> </ul>	610-00610-00	<ul style="list-style-type: none"> <li>• <i>OPI/O<sub>2</sub>/Solenoid/Battery Wiring Harness</i></li> </ul> <div style="text-align: center;">  </div>


<b>OPI WIRING HARNESS KIT</b>		
Concentrator Model #	Kit #	Included in Kit
<ul style="list-style-type: none"> <li>• <i>H600/H605 Concentrators</i></li> <li>• <i>M600/M605 Concentrators</i></li> <li>• <i>M10600/M10605 Concentrators</i></li> </ul>	610-00625-00	<ul style="list-style-type: none"> <li>• <i>OPI Wiring Harness</i></li> </ul>

<b>POWER SWITCH WIRING HARNESS KIT</b>		
Concentrator Model #	Kit #	Included in Kit
<ul style="list-style-type: none"> <li>• <i>H600/H605 Concentrators</i></li> <li>• <i>M600/M605 Concentrators</i></li> <li>• <i>M10600/M10605 Concentrators</i></li> </ul>	610-00615-00	<ul style="list-style-type: none"> <li>• <i>Power Switch Wiring Harness</i></li> </ul> <div style="text-align: center;">  </div>

<b>THERMAL PROTECTION SWITCH KIT</b>		
Concentrator Model #	Kit #	Included in Kit
<ul style="list-style-type: none"> <li>• <i>Enhanced M600/M605 Concentrators</i></li> <li>• <i>Enhanced M10600/M10605 Concentrators</i></li> </ul>	1017901	<ul style="list-style-type: none"> <li>• <i>Thermal Protection Switch</i></li> </ul> <div style="text-align: center;">  </div>

<b>MAIN PCB TO FAN CABLE WIRING KIT</b>		
Concentrator Model #	Kit #	Included in Kit
<ul style="list-style-type: none"> <li>• <i>Enhanced M600/M605 Concentrators</i></li> <li>• <i>Enhanced M10600/M10605 Concentrators</i></li> </ul>	1017560	<ul style="list-style-type: none"> <li>• <i>Main PCB to Fan Cable</i></li> </ul> <div style="text-align: center;">  </div>

<b>MAIN PCB TO BATTERY CABLE WIRING KIT</b>		
<b>Concentrator Model #</b>	<b>Kit #</b>	<b>Included in Kit</b>
<ul style="list-style-type: none"> <li>• <i>Enhanced M600/M605 Concentrators</i></li> <li>• <i>Enhanced M10600/M10605 Concentrators</i></li> </ul>	1017837	<ul style="list-style-type: none"> <li>• <i>Main PCB to Battery Cable</i></li> </ul> 

<b>MAIN PCB TO COMPRESSOR CABLE WIRING KIT</b>		
<b>Concentrator Model #</b>	<b>Kit #</b>	<b>Included in Kit</b>
<ul style="list-style-type: none"> <li>• <i>Enhanced M600/M605 Concentrators</i></li> <li>• <i>Enhanced M10600/M10605 Concentrators</i></li> </ul>	1024060	<ul style="list-style-type: none"> <li>• <i>Main PCB to Compressor Cable</i></li> </ul> 



*This page intentionally left blank.*

## **H600/605; M600/605; ENHANCED M600/605 TESTING**

### **SYSTEM VERIFICATION PROCEDURES**

#### ***BATTERY TEST & REPLACEMENT***

Test the condition of the 9-volt battery as follows:

1. With the unit disconnected from the power source, move the Power Switch to the ON (I) position and verify that the red LED alarm illuminates and the audible alarm sounds.

**NOTE**

The battery should provide sufficient power to alarm for 10 minutes.

2. If the red LED does not illuminate or the audible alarm does not sound, install a new 9-volt battery. Be sure to move the Power Switch to the OFF (O) position, then proceed as follows.
  - a. Remove the rear access door.
  - b. Remove the Pre-inlet Filter and the Inlet filter.
  - c. Locate the 9-volt battery and the battery holder clips. Remove the battery from its holder.
  - d. Remove the battery connector from the battery, and check the no-load voltage with a DMM. If the voltage is less than 5 volts, install a new battery.

#### ***SYSTEM SELF TEST AND START UP TEST***

1. Connect the Power Cord to a power source.
2. Turn on the unit by moving the Power Switch to the ON (I) position and verify the following:
  - All LEDs light up and the audible alarm sounds for two seconds.
  - The unit starts running.
  - The red LED light goes off and the audible alarm stops.
  - The yellow LED blinks until the specified oxygen level is reached (OPI version Only).

#### ***SYSTEM PRESSURE TEST***

The system pressure test is used to verify the internal operating pressures of the Millennium Oxygen Concentrator.

1. Turn on the unit by moving the Power Switch to the ON (I) position. Let the unit run for a minimum of one hour.
2. Turn off the Millennium Oxygen Concentrator.
3. Remove the Front and Rear Cabinets from the unit.
4. Disconnect the yellow pressure tubing from the fitting on the top of the Sieve Canister Assembly. Using the pressure gauge, "T" fitting and pressure tubing supplied with the Millennium tool kit (Respironics p/n H647), connect a pressure gauge to the long yellow pressure tubing and the Sieve Canister Assembly.
5. Turn the unit on and set the flow to 5 lpm. Allow the unit to cycle for at least two (2) minutes to stabilize.
6. Hold the pressure gauge in a vertical position.

7. Monitor the pressure gauge. The gauge should cycle as listed below:
  - H-600/605 120V Concentrators between 25 and 29 psi @ 5 lpm.
  - H600/605 230V Concentrators between 21 and 25 psi @ 5 lpm.
  - M600/605; Enhanced M600/605 120V Concentrators between 25 and 29 psi @ 5 lpm.
  - M600/605; Enhanced M600/605 230V Concentrators  $\geq 15$  psi @ 5 lpm.

**NOTE**

*If the pressure is not within specifications and there are no leaks in the system, perform Compressor maintenance.*

8. Read the peak pressure for four cycles, and confirm that all peaks are within one (1) psig of each other.

**NOTE**

*If the four cycles are not within specification, proceed to the system pressure test table, located in the Troubleshooting Section, for diagnostic information.*

9. Disconnect the pressure gauge, "T" fitting, and tubing. Reconnect the yellow tubing to the fitting on the top of the Sieve Canister.
10. Install the Front and Rear Cabinets.

### **OXYGEN OUTLET/REGULATED PRESSURE TEST**

**NOTE**

*When testing a concentrator equipped with a pediatric Flow Meter, substitute 1 lpm where 5 lpm is called out in this test.*

1. Turn on the unit by moving the Power Switch to the ON (I) position. Let the unit run for at least two (2) minutes to stabilize.
2. Set the Flow Meter to 5 lpm (1 lpm for concentrators equipped with a Pediatric Flow Meter).
3. Connect the pressure gauge from the tool kit to the DISS outlet fitting. The flow ball should drop to 0.0 lpm.
4. If the oxygen pressure does not fall between 5.0 and 7.0 psig, perform steps 5 through 13. If the pressure does fall between 5.0 and 7.0 psig proceed to next test.
5. Remove the pressure gauge from the DISS outlet fitting.
6. Remove the Front and Rear Cabinets.
7. Insert a "T" from the tool kit in between the regulator and the clear oxygen tubing, and connect the pressure gauge.
8. Set the Flow Meter to 5 lpm (1 lpm for concentrators equipped with a Pediatric Flow Meter).
9. With the gauge held in a vertical position, verify that the regulated pressure is at  $5.5 \pm 0.25$  psig.

10. If the regulated pressure needs adjusted, place a 5/32" Allen wrench in the adjusting screw on the end of the regulator.

**NOTE**

*If the regulated pressure is low, turn the wrench clockwise to increase the regulated pressure. If the regulated pressure is high, turn the wrench counter clockwise to decrease the pressure.*

11. Disconnect the pressure gauge and "T" fitting.
12. Reconnect the clear oxygen tubing to the pressure regulator.
13. Install the Front and Rear Cabinets.

**OPI PCB OXYGEN VERIFICATION (MODEL 605 ONLY)**

This procedure verifies that the OPI Board is operating properly.

1. Turn on the unit by moving the Power Switch to the ON (I) position. Let the unit run for a minimum of one hour.
2. Remove the Rear Cabinet.
3. Set the Flow Meter to 5 lpm (except for H605 230V, set to 4 lpm).

**NOTE**

*The oxygen analyzer used in the following steps must be calibrated to meet the manufacturer's specifications.*

4. Connect an oxygen analyzer to the DISS outlet.
5. Set the DMM to VDC. Connect the red test lead to pin 16 and the black test lead to pin 19 on the power control board.
6. Observe the oxygen analyzer for three cycles, and record the oxygen reading for each cycle.
7. Add the three oxygen readings, and then divide by three to find the average oxygen purity.
8. Locate the average oxygen purity on the Oxygen Percentage Voltage Verification Char (refer to Figure A).
9. Compare the voltage reading from the DMM to the voltage listed on the chart for the oxygen purity average that you calculated (refer to Figure A).
10. The voltage reading from the DMM must fall within the values listed on the chart.
11. If the voltage does not fall within the guidelines, replace the OPI board.

**NOTE**

*If the oxygen purity is below 85% for the H605 concentrators or below 82% for the M605 & Enhanced M605 concentrators, use the troubleshooting table to determine the cause of the low oxygen readings.*

12. Install the Front and Rear Cabinets.

<b>OPI VOLTAGE VERIFICATION CHART MODEL 605 ONLY</b>	
<i>Oxygen Concentration Percentage Average</i>	<i>Average Acceptable Voltage Output (VDC)</i>
96%	3.96 to 3.72 VDC
95%	3.92 to 3.68 VDC
94%	3.88 to 3.64 VDC
93%	3.84 to 3.60 VDC
92%	3.80 to 3.56 VDC
91%	3.76 to 3.52 VDC
90%	3.72 to 3.48 VDC
89%	3.68 to 3.44 VDC
88%	3.64 to 3.40 VDC
87%	3.60 to 3.36 VDC
86%	3.56 to 3.32 VDC
85%	3.52 to 3.28 VDC
82%	3.40 to 3.16 VDC

**FIGURE A: OPI VOLTAGE VERIFICATION CHART**

## MILLENNIUM SYSTEM FINAL TEST

The following test must be performed after any repairs to the Millennium Oxygen Concentrator. The results of the test must be entered on the Testing Data Sheet provided and signed, in ink, and dated by the technician performing the test.

This test may also be used as a performance verification procedure on the unit between patient usages.

### NOTE

- *The results of this test must be recorded in the space provided on the Testing Data Sheet.*
- *All testing on the unit must be performed at the proper voltage and frequency applicable for the country where the unit is being used.*
- *Before starting the System Final Test, the unit must be turned on and run for a minimum of one hour with the Front and Rear cabinets in place.*

### TESTING PROCEDURE

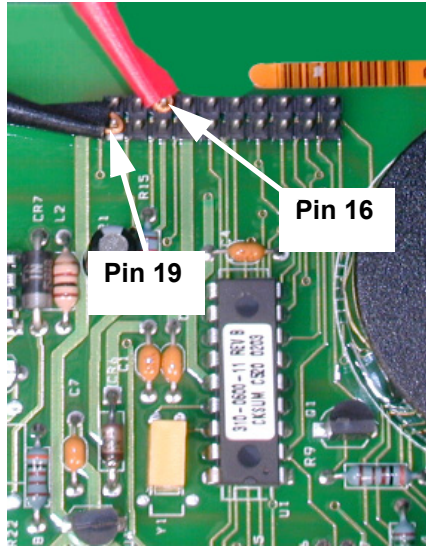
1. Ensure that the unit has been run-in for a minimum of one hour.
2. Record the serial number, located on the rear of the unit, in the space provided on the Testing Data sheet.
3. Record the voltage and frequency at which the unit is being tested.
4. Record the hours from the Hour Meter located on the lower right hand side of the unit.
5. Connect the pressure gauge to the DISS outlet fitting to test the “No Flow” alarm. The yellow LED (Low Oxygen) should illuminate and an intermittent alarm should sound within 60 seconds. Record the results.
6. With the pressure gauge still connected, and held in a vertical position, measure the oxygen outlet pressure. The oxygen outlet pressure should be within 5.0- 7.0 psig. If the oxygen outlet pressure needs adjusted refer to the Oxygen Outlet/Regulated Pressure Test Section. Record the results.

### NOTE

*Step 7 should only be performed on All Model 605 concentrators.*

7. Connect the black ground lead from the DMM to pin 19 and the red positive lead to pin 16 on the Main PCB. Set the multimeter to VDC. Set the Flow Meter to 5 lpm, and connect a calibrated oxygen analyzer to the DISS outlet. Observe the oxygen analyzer and the multimeter simultaneously. Record each reading for three cycles. Add the three oxygen readings, and then divide by three to

find the average oxygen purity. Locate the average oxygen purity on the Oxygen Percentage Voltage Verification Chart (refer to Figure A). Mark pass or fail on the data sheet.



**FIGURE B: PIN LOCATIONS**

8. Set the Flow Meter to 5 lpm (except for H60/H605 230V, set to 4 lpm, and for units equipped with a Pediatric Flow Meter set to 1 lpm). With the oxygen analyzer still connected to the DISS outlet, measure and record the oxygen concentration. Set the Flow Meter to two (2) lpm (except for units equipped with a Pediatric Flow Meter set to 0.1 lpm). Measure and record the oxygen concentration.

## NOTE

*After completing step 8, the oxygen analyzer and tubing can be removed from the DISS outlet. The multimeter and the test leads can be removed from the Main PCB.*

9. Reinstall the Front and Rear Cabinets.
10. In ink, sign and date the Testing Data Sheet after all tests have been completed. If the unit has failed any of the tests performed, the unit must be repaired and retested according to this service manual.



## MODEL 605 TEST DATA SHEET

### NOTE

All information on this data sheet should be entered in the correct location after the associated test was completed. The data sheet must then be signed in ink and dated by the technician performing tests.

**Step 2**

Serial Number: \_\_\_\_\_

**Step 3**

VAC: \_\_\_\_\_ Hz: \_\_\_\_\_

**Step 4**

Hour Meter: \_\_\_\_\_

**Step 5**

No Flow Alarms ≤ 60 sec.	PASS	FAIL

**Step 6**

Oxygen Outlet Pressure 5.0-7.0 psig	PRESSURE GAUGE READING

**Step 7**

Oxygen Analyzer Reading	1ST CYCLE	2ND CYCLE	3RD CYCLE
Average O2 Purity (3 cycles) DMM Voltage Reading			
PASS		FAIL	

**Step 8**

Flow Meter Oxygen Concentration	M605; H605 120V		H605 230V		M605; Enhanced M605 230V	
	2 lpm	5 lpm	2 lpm	4 lpm	2 lpm	5 lpm
	≥ 88 % @ 5 lpm ≥ 92% @ 0.5 to 4 lpm		≥ 87 @ 4 lpm ≥ 92 @ 0.5 to 3 lpm		≥ 94 +/- 2% @ 0.5 to 4 lpm ≥ 92 +/-4% @ 5 lpm (all models except M605-70) ≥ 88 +/- 4% @ 5 lpm (Model M605-70 only)	

Signature: \_\_\_\_\_ Date: \_\_\_\_\_ Notification Number: \_\_\_\_\_

(RI internal use Only)

## MODEL 600 TEST DATA SHEET

### NOTE

All information on this data sheet should be entered in the correct location after the associated test was completed. The data sheet must then be signed in ink and dated by the technician performing tests.

#### Step 2

Serial Number: \_\_\_\_\_

#### Step 3

VAC: \_\_\_\_\_ Hz: \_\_\_\_\_

#### Step 4

Hour Meter: \_\_\_\_\_

#### Step 5

No Flow Alarms ≤ 60 sec.	PASS	FAIL

#### Step 6

Oxygen Outlet Pressure 5.0-7.0 psig	PRESSURE GAUGE READING

### NOTE

Step 7 is not required for this Model.

#### Step 8

Flow Meter Oxygen Concentration	H600; M600 120V		H600 230V		M600; Enhanced M600 230V	
	$\geq 88\% @ 5 \text{ lpm}$ $\geq 92\% @ 0.5 \text{ to } 4 \text{ lpm}$		$\geq 87 @ 4 \text{ lpm}$ $\geq 92 @ 0.5 \text{ to } 3 \text{ lpm}$		$\geq 94 \pm 2\% @ 0.5 \text{ to } 4 \text{ lpm}$ $\geq 92 \pm 4\% @ 5 \text{ lpm}$	
	2 lpm	5 lpm	2 lpm	4 lpm	2 lpm	5 lpm

Signature: \_\_\_\_\_ Date: \_\_\_\_\_ Notification Number: \_\_\_\_\_

(RI internal use Only)

**MODEL 605 W/PEDIATRIC FLOW METER TEST DATA SHEET**

**NOTE**

All information on this data sheet should be entered in the correct location after the associated test was completed. The data sheet must then be signed in ink and dated by the technician performing tests.

**Step 2** Serial Number: \_\_\_\_\_ **Step 3** VAC: \_\_\_\_\_ Hz: \_\_\_\_\_ **Step 4** Hour Meter: \_\_\_\_\_

**NOTE**

Step 5 is not required for this Model. The Alarm will not sound with the 1 Liter Pediatric Flowmeter installed.

**Step 6**

<b>Oxygen Outlet Pressure</b> 5.0-7.0 psig	<b>PRESSURE GAUGE READING</b>

**Step 7**

<b>Oxygen Analyzer Reading</b>	<b>1ST CYCLE</b>	<b>2ND CYCLE</b>	<b>3RD CYCLE</b>
<b>Average O2 Purity (3 cycles)</b>			
<b>DMM Voltage Reading</b>			
<b>PASS</b>		<b>FAIL</b>	

**Step 8**

<b>Flow Meter Oxygen Concentration</b>	<b>H605; M605; Enhanced M605</b> <b>120V</b>	
	<b>≥ 92% @ 0.1 lpm to 1 lpm</b>	
	<b>0.1 lpm</b>	<b>1 lpm</b>

Signature: \_\_\_\_\_ Date: \_\_\_\_\_ Notification Number: \_\_\_\_\_

(RI internal use Only)

## MODEL 600 W/PEDIATRIC FLOW METER TEST DATA SHEET

**NOTE**

*All information on this data sheet should be entered in the correct location after the associated test was completed. The data sheet must then be signed in ink and dated by the technician performing tests.*

**Step 2** Serial Number: \_\_\_\_\_     
 **Step 3** VAC: \_\_\_\_\_ Hz: \_\_\_\_\_     
 **Step 4** Hour Meter: \_\_\_\_\_

**NOTE**

*Step 5 is not required for this Model. The Alarm will not sound with the 1 Liter Pediatric Flowmeter installed.*

**Step 6**

<b>Oxygen Outlet Pressure</b>	<b>PRESSURE GAUGE READING</b>
5.0-7.0 psig	

**NOTE**

*Step 7 is not required for this Model.*

**Step 8**

<b>Flow Meter Oxygen Concentration</b>	<b>H600; M600; Enhanced M600 120V</b>	
	<b>≥ 92% @ 0.1 lpm to 1 lpm</b>	
	<b>0.1 lpm</b>	<b>1 lpm</b>

Signature: \_\_\_\_\_ Date: \_\_\_\_\_ Notification Number: \_\_\_\_\_

*(RI internal use Only)*

*This page intentionally left blank.*

---

## M10600/M10605 & ENHANCED M10600/M10605 TESTING

### SYSTEM VERIFICATION PROCEDURES

#### ***BATTERY TEST & REPLACEMENT***

Test the condition of the 9-volt battery as follows:

1. With the unit disconnected from the power source, move the Power Switch to the ON (I) position and verify that the red LED alarm illuminates and the audible alarm sounds.
2. The battery should provide sufficient power to alarm for 10 minutes.
3. If the red LED does not illuminate or the audible alarm does not sound, install a new 9-volt battery. Be sure to move the Power Switch to the OFF (0) position, then proceed as follows.
  - a. Remove the rear access door.
  - b. Remove the Pre-inlet Filter, and the Inlet Filter.
  - c. Locate the 9-volt battery, and the battery holder clips. Remove the battery from its holder.
  - d. Remove the battery connector from the battery and check the no-load voltage with a DMM. If the voltage is less than 5 volts, install a new battery.

#### ***SYSTEM SELF TEST AND START UP TEST***

1. Connect the Power Cord to a power source.
2. Turn on the unit by moving the Power Switch to the ON (I) position and verify the following:
  - All LEDs light up and the audible alarm sounds for two seconds.
  - The unit starts running.
  - The red LED light goes off and the audible alarm stops.
  - The yellow LED blinks until the specified oxygen level is reached (OPI version Only).

#### ***SYSTEM PRESSURE TEST***

The system pressure test is used to verify the internal operating pressures of the Millennium Oxygen Concentrator.

1. Turn on the unit by moving the Power Switch to the ON (I) position. Let the unit run for a minimum of one hour.
2. Turn off the Millennium Oxygen Concentrator.
3. Remove the Front and Rear Cabinets from the unit.
4. Disconnect the yellow pressure tubing from the fitting on the top of the Sieve Canister Assembly. Using the pressure gauge, "T" fitting, and pressure tubing supplied with the Millennium tool kit (Respironics p/n H647), connect a pressure gauge to the long yellow pressure tubing, and the Sieve Canister Assembly.
5. Turn the unit on, and set the flow to 10 lpm. Allow the unit to cycle for at least two (2) minutes to stabilize.
6. Hold the pressure gauge in a vertical position.

7. Monitor the pressure gauge. The gauge pressure should read  $\geq 20$  psi.

**NOTE**

*If the pressure is not within specifications and there are no leaks in the system, perform Compressor maintenance.*

8. Read the peak pressure for four cycles and confirm that all peaks are within one (1) psig of each other.

**NOTE**

*If the four cycles are not within specification, proceed to the system pressure test table for diagnostic information.*

9. Disconnect the pressure gauge, "T" fitting, and tubing. Reconnect the yellow tubing to the fitting on the top of the Sieve Canister.
10. Install the Front and Rear Cabinets.

#### **OXYGEN OUTLET/REGULATED PRESSURE TEST**

1. Turn on the unit by moving the Power Switch to the ON (I) position. Let the unit run for at least two (2) minutes to stabilize.
2. Set the Flow Meter to 10 lpm.
3. Connect the pressure gauge from the tool kit to the DISS outlet fitting. The flow ball should drop to 0.0 lpm.
4. If the oxygen pressure does not fall between 5.0 and 7.0 psig, perform steps 5 through 13. If the pressure does fall between 5.0 and 7.0 psig proceed to step 5.
5. Remove the pressure gauge from the DISS outlet fitting.
6. Remove the Front and Rear Cabinets.
7. Insert a "T" from the tool kit in between the regulator and the clear oxygen tubing, and connect the pressure gauge.
8. Set the Flow Meter to 10 lpm.
9. With the gauge held in a vertical position, verify that the regulated pressure is at  $5.5 \pm 0.25$  psig.
10. If the regulated pressure needs adjusted, place a 5/32" Allen wrench in the adjusting screw on the end of the regulator.

**NOTE**

*If the regulated pressure is low, turn the wrench clockwise to increase the regulated pressure. If the regulated pressure is high, turn the wrench counter-clockwise to decrease the pressure.*

11. Disconnect the pressure gauge, and "T" fitting.
12. Reconnect the clear oxygen tubing to the pressure regulator.
13. Install the Front and Rear Cabinets.

**OPI PCB OXYGEN VERIFICATION (M10605/ ENHANCED M10605 ONLY)**

This procedure verifies that the OPI Board is operating properly.

1. Turn on the unit by moving the Power Switch to the ON (I) position. Let the unit run for a minimum of one hour.
2. Remove the Rear Cabinet.
3. Set the Flow Meter to 10 lpm.

**NOTE**

*The oxygen analyzer used in the following steps must be calibrated to meet the manufacturer's specifications.*

4. Connect an oxygen analyzer to the DISS outlet.
5. Set the DMM to VDC. Connect the red test lead to pin 16 and the black test lead to pin 19 on the Main PCA.
6. Observe the oxygen analyzer for three cycles, and record the oxygen reading for each cycle.
7. Add the three oxygen readings, and then divide by three to find the average oxygen purity.
8. Locate the average oxygen purity on the Oxygen Percentage Voltage Verification Chart (refer to Figure A).
9. Compare the voltage reading from the DMM to the voltage listed on the chart for the oxygen purity average that you calculated (refer to Figure A).
10. The voltage reading from the DMM must fall within the values listed on the chart.
11. If the voltage does not fall within the guidelines, replace the OPI board.

**NOTE**

*If the oxygen purity is below 82%, use the troubleshooting table to determine the cause of the low oxygen readings.*

12. Install the Front and Rear Cabinets.



<b>OPI VOLTAGE VERIFICATION CHART MODEL 605 ONLY</b>	
<i>Oxygen Concentration Percentage Average</i>	<i>Average Acceptable Voltage Output (VDC)</i>
96%	3.96 to 3.72 VDC
95%	3.92 to 3.68 VDC
94%	3.88 to 3.64 VDC
93%	3.84 to 3.60 VDC
92%	3.80 to 3.56 VDC
91%	3.76 to 3.52 VDC
90%	3.72 to 3.48 VDC
89%	3.68 to 3.44 VDC
88%	3.64 to 3.40 VDC
87%	3.60 to 3.36 VDC
86%	3.56 to 3.32 VDC
85%	3.52 to 3.28 VDC
82%	3.40 to 3.16 VDC

**FIGURE A: OPI VOLTAGE VERIFICATION CHART**

## MILLENNIUM SYSTEM FINAL TEST

The following test must be performed after any repairs to the Millennium Oxygen Concentrator. The results of the test must be entered on the Testing Data Sheet provided and signed, in ink, and dated by the technician performing the test.

This test may also be used as a performance verification procedure on the unit between patient usages.

### NOTE

- *The results of this test must be recorded in the space provided on the Testing Data Sheet.*
- *All testing on the unit must be performed at the proper voltage and frequency applicable for the country where the unit is being used.*
- *Before starting the System Final Test, the unit must be turned on and run for a minimum of one hour with the Front and Rear Cabinets in place.*

### TESTING PROCEDURE

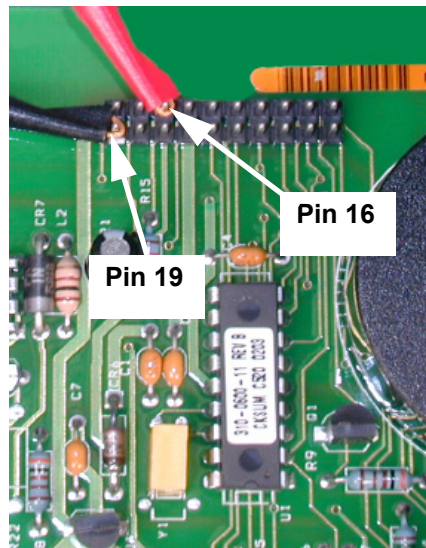
1. Ensure that the unit has been run-in for a minimum of one hour.
2. Record the serial number, located on the rear of the unit, in the space provided on the Testing Data sheet.
3. Record the voltage and frequency at which the unit is being tested.
4. Record the hours from the Hour Meter located on the lower right hand side of the unit.
5. Connect the pressure gauge to the DISS outlet fitting to test the “No Flow” alarm. The yellow LED (Low Oxygen) should illuminate and an intermittent alarm should sound within 60 seconds. Record the results.
6. With the pressure gauge still connected and held in a vertical position, measure the oxygen outlet pressure. The oxygen outlet pressure should be within 5.0- 7.0 psi. If the oxygen outlet pressure needs adjusted refer to the Oxygen Outlet/Regulated Pressure Test Section. Record the results.

### NOTE

*Step 7 should only be performed on Millennium M10605/Enhanced M10605 concentrators.*

7. Connect the black ground lead from the DMM to pin 19 and the red positive lead to pin 16 on the Main PCB. Set the multimeter to VDC. Set the Flow Meter to 10 lpm, and connect a calibrated oxygen analyzer to the DISS outlet. Observe the oxygen analyzer and the multimeter simultaneously. Record each reading for three cycles. Add the three oxygen readings, and then divide by

three to find the average oxygen purity. Locate the average oxygen purity on the Oxygen Percentage Voltage Verification Chart (refer to Figure A). Mark pass or fail on the data sheet.



**FIGURE B: PIN LOCATIONS**

8. Set the Flow Meter to 10 lpm. With the oxygen analyzer still connected to the DISS outlet, measure and record the oxygen concentration. Set the Flow Meter to three (3) lpm. Measure and record the oxygen concentration.

## NOTE

*After completing step 8, the oxygen analyzer and tubing can be removed from the DISS outlet. The multimeter and the test leads can be removed from the Main PCB.*

9. Reinstall the Front and Rear Cabinets.
10. In ink, sign and date the Testing Data Sheet after all tests have been completed. If the unit has failed any of the tests performed, the unit must be repaired and retested according to this service manual.

## MODEL M10605 TEST DATA SHEET

### NOTE

All information on this data sheet should be entered in the correct location after the associated test was completed. The data sheet must then be signed in ink and dated by the technician performing tests.

**Step 2**

Serial Number: \_\_\_\_\_

**Step 3**

VAC: \_\_\_\_\_ Hz: \_\_\_\_\_

**Step 4**

Hour Meter: \_\_\_\_\_

**Step 5**

No Flow Alarms ≤ 60 sec.	PASS	FAIL

**Step 6**

Oxygen Outlet Pressure 5.0-7.0 psig	PRESSURE GAUGE READING

**Step 7**

Oxygen Analyzer Reading	1ST CYCLE	2ND CYCLE	3RD CYCLE
Average O2 Purity (3 cycles) DMM Voltage Reading			
PASS		FAIL	

**Step 8**

Flow Meter Oxygen Concentration	<b>M10605; Enhanced M10605 120V</b>	
	<b>92% +/- 4 @ 10 lpm 94% +/- 2 @ 3 lpm</b>	
	<b>3 lpm</b>	<b>10 lpm</b>

Signature: \_\_\_\_\_ Date: \_\_\_\_\_ Notification Number: \_\_\_\_\_

(RI internal use Only)

**MODEL M10600 TEST DATA SHEET**

**NOTE**

All information on this data sheet should be entered in the correct location after the associated test was completed. The data sheet must then be signed in ink and dated by the technician performing tests.

**Step 2** Serial Number: \_\_\_\_\_     
 **Step 3** VAC: \_\_\_\_\_ Hz: \_\_\_\_\_     
 **Step 4** Hour Meter: \_\_\_\_\_

**Step 5**

No Flow Alarms ≤ 60 sec.	PASS	FAIL

**Step 6**

Oxygen Outlet Pressure 5.0-7.0 psig	PRESSURE GAUGE READING

**NOTE**

Step 7 is not required for this Model.

**Step 8**

Flow Meter Oxygen Concentration	M-10600; Enhanced M10600 120V	
	92% +/- 4 @ 10 lpm 94% +/- 2 @ 3 lpm	
	3 lpm	10 lpm

Signature: \_\_\_\_\_ Date: \_\_\_\_\_ Notification Number: \_\_\_\_\_

(RI internal use Only)

## TOOLS & TEST EQUIPMENT

This chapter describes the necessary tools and test equipment to service the Millennium Oxygen Concentrators.

### SERVICE TOOLS & SUPPLIES

The following hand tools, supplies, and equipment should be available for service technicians to troubleshoot, test, and repair the Millennium Oxygen Concentrator system. The tools listed below are necessary for repairing ALL models of Millennium Concentrators.

- ESD protected work station (minimum requirement is a grounded mat and wrist strap)
- Flat Head Screwdriver (large blade)
- 9/16" wrench or deep well socket
- 11/16" wrench
- 15 in-lbs. Torque wrench (Respironics p/n 1033056)
- 18 in-lbs. Torque wrench (Respironics p/n 1018495)
- 30 in-lbs. Torque wrench (Respironics p/n 1033057)
- 55 in-lbs. Torque wrench (Respironics p/n 1018490)
- 100 in-lbs. Torque wrench (Respironics p/n 1024064)
- 125 in-lbs. Torque wrench (Respironics p/n 1024062)
- 1/4" Drive Torx Bit Holder (Respironics p/n 1033058)
- 3/8" Drive Torx Bit Holder (Respironics p/n 1040446)
- Hog ring or slip-joint pliers (medium)
- Needle-nose pliers (insulated)
- Channel locks (medium)
- Diagonals (wire cutters)
- Fuse extractor
- Crimping clamp tool (Respironics p/n H645 (Included in H647 Tool Kit))
- Rubber mallet
- Amp terminal retractor tool (Respironics p/n 1033059 (Included in H647 Tool Kit))
- Heyco tool (Respironics p/n 1040212)

### **SUPPLIES**

- Cleaning cloth
- Cleaner (i.e., Fantastik®, 409®)
- Isopropyl alcohol
- Mild detergent
- Disinfectant
- Teflon® thread tape

### **EQUIPMENT**

- Digital multimeter
- Calibrated oxygen analyzer
- Stop watch
- Millennium tool kit Respironics p/n H647 (Includes: Respironics p/n H646 Millennium screwdriver w/bits, Respironics p/n H648 Pressure gauge kit, Respironics p/n 1033059 Amp retractor tool, Respironics p/n H645 Crimping clamp tool)
- Millennium Screwdriver w/bits (Respironics p/n H646 (Included in H647 Tool Kit))
- Millennium Pressure gauge kit (Respironics p/n H648 (Included in H647 Tool Kit))

## **ACCEPTABLE TEST EQUIPMENT**

### **DIGITAL MULTIMETER**

Specification:

- 3 1/2 digit readout

Acceptable Options:

- Fluke 87 or better model
- Any commercially available multimeter that meets the above specifications

### **OXYGEN ANALYZER**

**NOTE**

*The oxygen analyzer used must be calibrated to meet the manufacturer's specifications.*

Specifications:

- Range: 0.0% to 100.0% O<sub>2</sub>
- Accuracy: ± 2.0% O<sub>2</sub>

Acceptable Options:

- MSA MiniOXI-CE Oxygen Analyzer (Respironics p/n 27009)
- Any commercially available Oxygen Analyzer that meets the above specifications

## **SCHEMATICS**

### **SCHEMATICS STATEMENT**

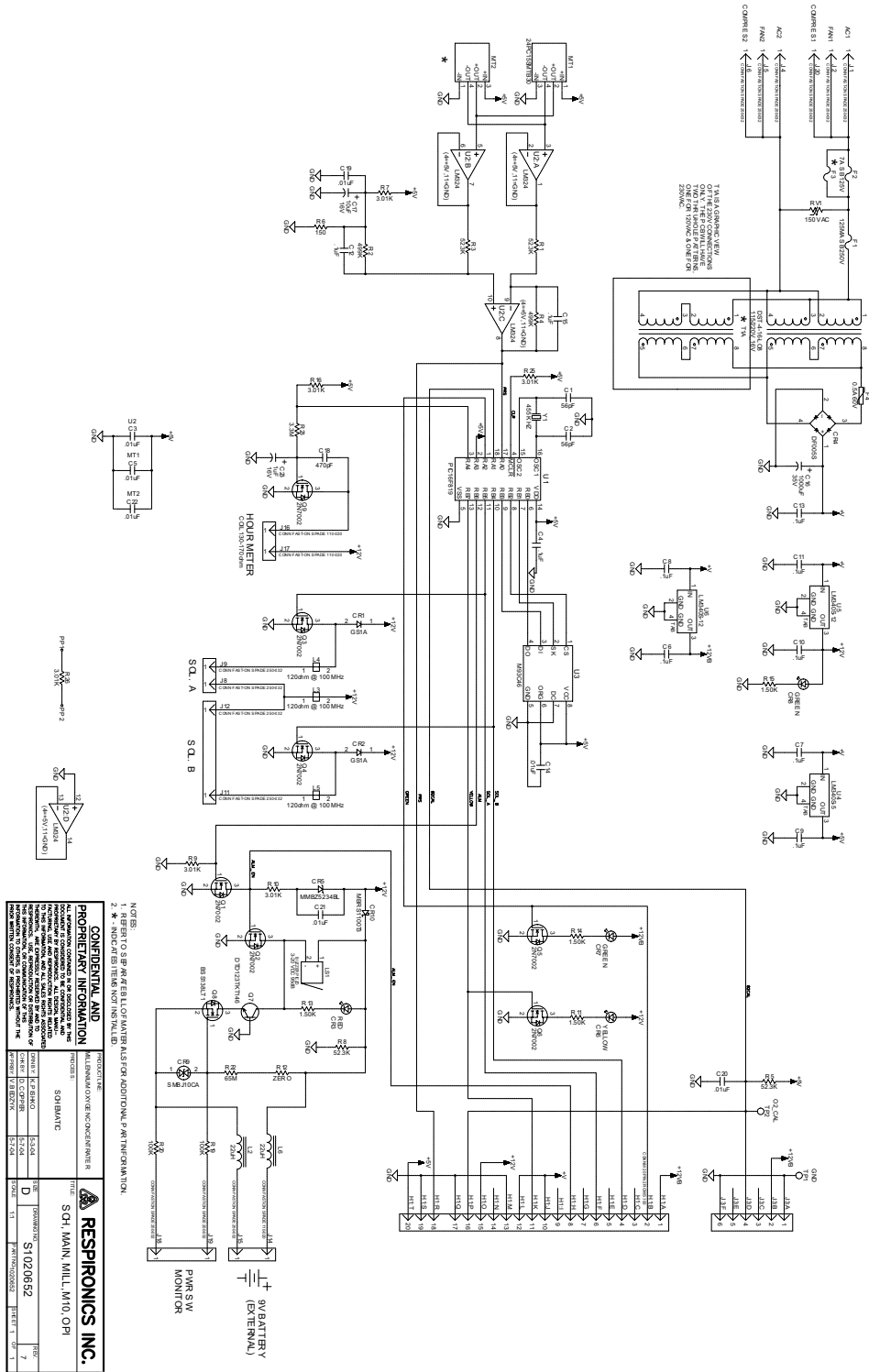
Schematics are supplied with this manual in direct support of the sale and purchase of this product.

**The schematics are proprietary and confidential. Do not copy the schematics or disclose them to third parties beyond the purpose for which they are intended. Patents are pending.**

The schematics are intended to satisfy administrative requirements only. They are not intended to be used for component level testing and repair. Any changes of components could effect the reliability of the device, prohibit lot tracking of electronic components, and void warranties. Repairs and testing are supported only at the complete board level.

The schematics are of the revision level in effect at the time this manual was last revised. New revisions may or may not be distributed in the future.

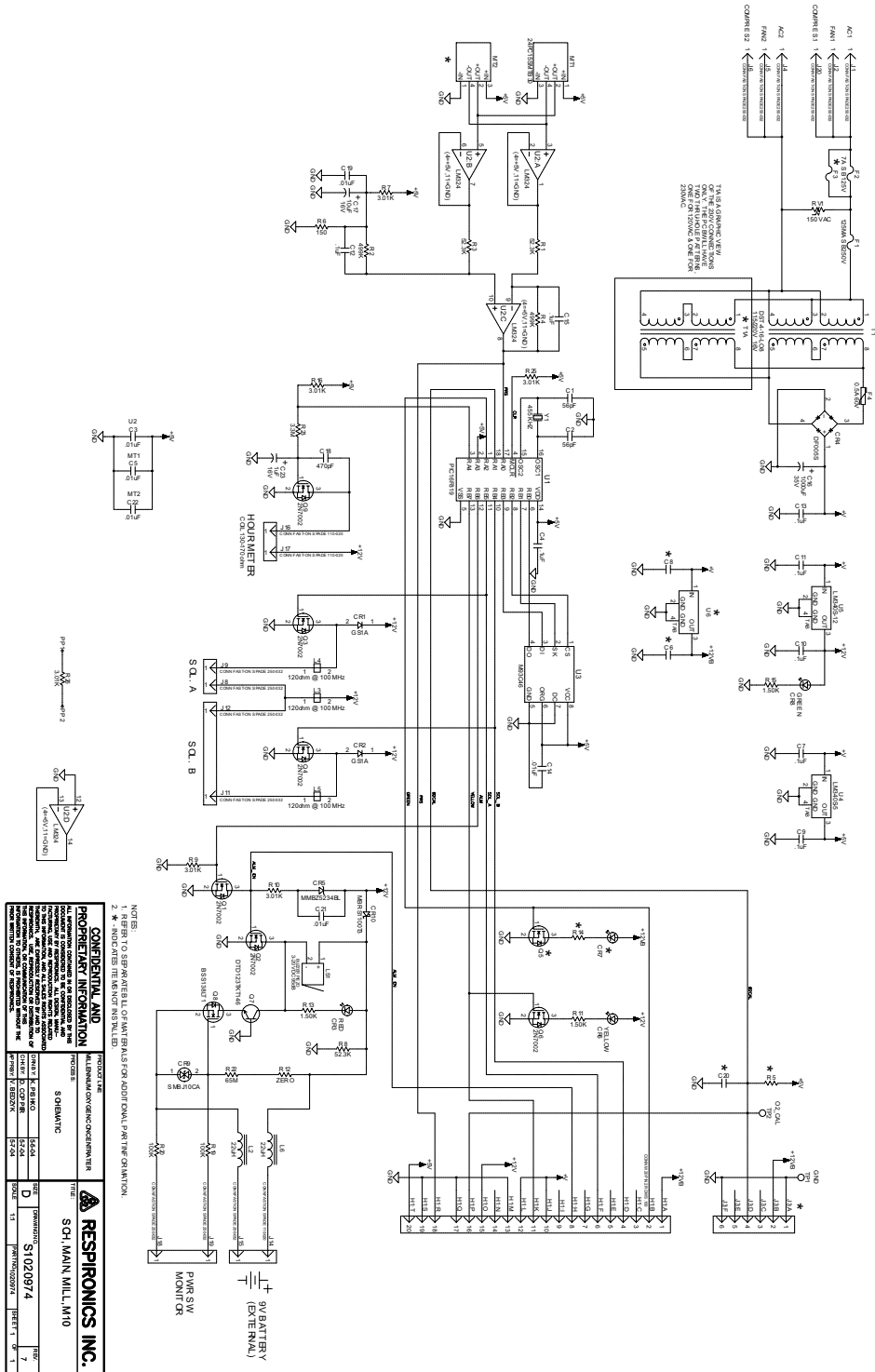




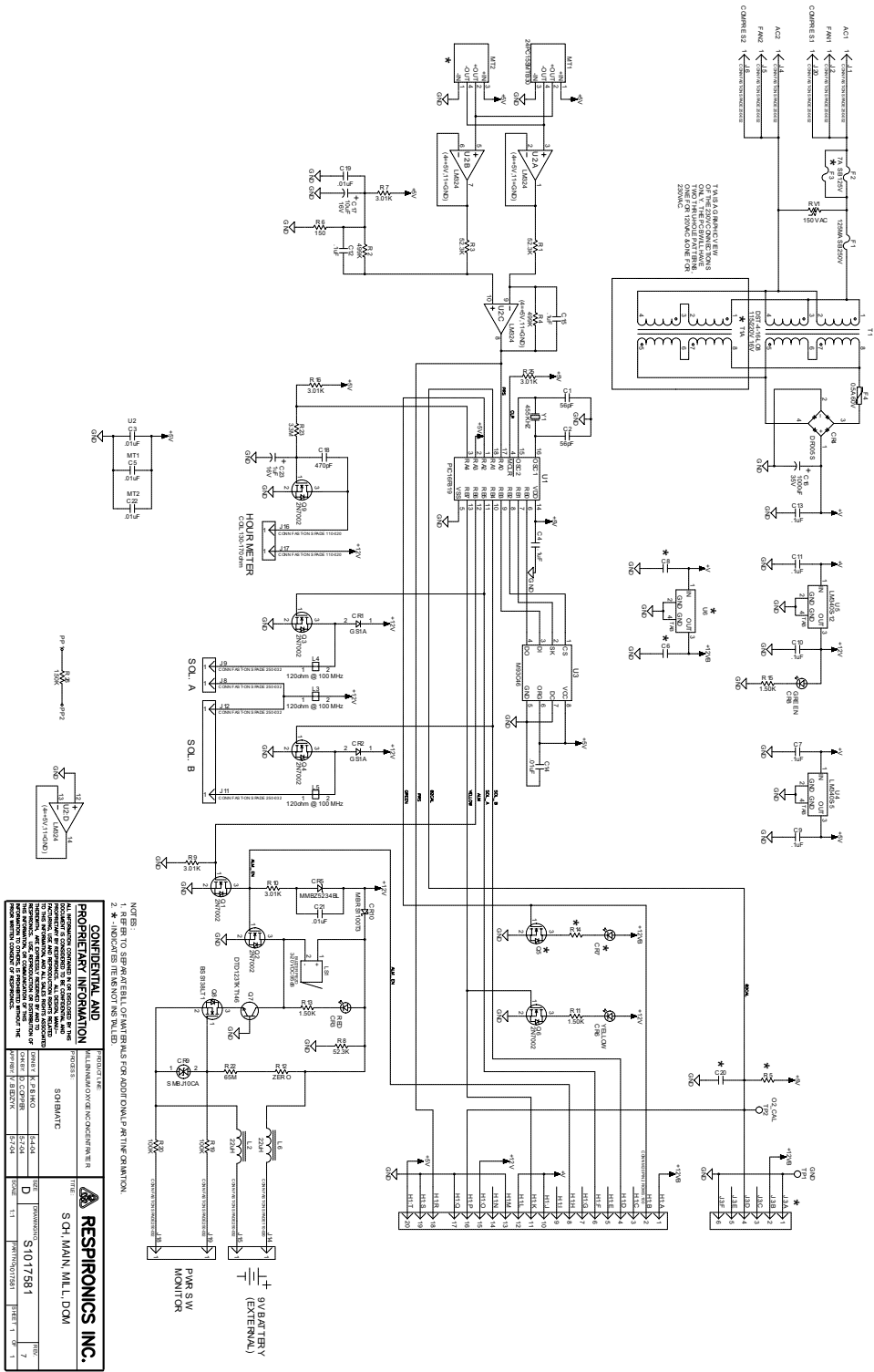
- NOTES:  
 1. REFER TO SUPPLIER FOR PART NUMBER FOR ADDITIONAL INFORMATION.  
 2. ALL RESISTORS ARE 1% TOLERANCE UNLESS NOTED OTHERWISE.

RESPIRONICS INC.		MILLENNIUM SERVICE & TECHNICAL INFORMATION	
CONFIDENTIAL AND PROPRIETARY INFORMATION		CONFIDENTIAL AND PROPRIETARY INFORMATION	
S01BANTC		S01BANTC	
DATE: 11/11/00	REV: 1.0	DATE: 11/11/00	REV: 1.0
DESIGNED BY: J. P. BARKO	3.03A	DESIGNED BY: J. P. BARKO	3.03A
CHECKED BY: D. C. GIBSON	2.02A	CHECKED BY: D. C. GIBSON	2.02A
DATE: 11/11/00	REV: 1.0	DATE: 11/11/00	REV: 1.0
DESIGNED BY: J. P. BARKO	3.03A	DESIGNED BY: J. P. BARKO	3.03A
CHECKED BY: D. C. GIBSON	2.02A	CHECKED BY: D. C. GIBSON	2.02A
DATE: 11/11/00	REV: 1.0	DATE: 11/11/00	REV: 1.0
DESIGNED BY: J. P. BARKO	3.03A	DESIGNED BY: J. P. BARKO	3.03A
CHECKED BY: D. C. GIBSON	2.02A	CHECKED BY: D. C. GIBSON	2.02A
DATE: 11/11/00	REV: 1.0	DATE: 11/11/00	REV: 1.0
DESIGNED BY: J. P. BARKO	3.03A	DESIGNED BY: J. P. BARKO	3.03A
CHECKED BY: D. C. GIBSON	2.02A	CHECKED BY: D. C. GIBSON	2.02A





<b>CONFIDENTIAL AND PROPRIETARY INFORMATION</b>	
ALL INFORMATION CONTAINED HEREIN IS UNCLASSIFIED EXCEPT WHERE SHOWN OTHERWISE. THIS INFORMATION IS THE PROPERTY OF RESPIRONICS, INC. AND IS NOT TO BE DISCLOSED TO ANY OTHER PARTY WITHOUT THE WRITTEN PERMISSION OF RESPIRONICS, INC. ANY UNAUTHORIZED DISCLOSURE OF THIS INFORMATION IS STRICTLY PROHIBITED AND IS SUBJECT TO PROSECUTION TO THE FULL EXTENT OF THE LAW.	
INDUSTRY PROCESS	INDUSTRY PROCESS
RESPIRONICS, INC.	RESPIRONICS, INC.
10000 WILLOW CREEK DRIVE	10000 WILLOW CREEK DRIVE
CHICAGO, IL 60648	CHICAGO, IL 60648
TEL: 773.399.1100	TEL: 773.399.1100
FAX: 773.399.1101	FAX: 773.399.1101
WWW.RESPIRONICS.COM	WWW.RESPIRONICS.COM
DATE: 11/20/07	DATE: 11/20/07
REV: 11	REV: 11
10120974	10120974
1	1



*This page intentionally left blank.*



1001 Murry Ridge Lane  
Murrysville, PA 15668  
[www.respironics.com](http://www.respironics.com)

Respironics Deutschland  
Gewerbestrasse 17  
82211 Herrsching, Germany

The logo for Respironics, featuring a stylized white wave above the word "RESPIRONICS" in a white, sans-serif, all-caps font. A registered trademark symbol (®) is located at the end of the word.

RESPIRONICS®

Millennium  
Oxygen  
Concentrators

Service & Technical  
Information